

JLN-740A/740N JLN-741A/741N

DOPPLER LOG

Instruction Manual

General	1
Function of Each Components	2
Operation Method (JLN-740A/741A)	3
Menu Settings and Configurations (JLN-740A/741A)	4
Operation Method (JLN-740N/741N)	5
Menu Settings and Configurations (JLN-740N/741N)	6
Operation Method (Option)	7
Setting by Using Menus (Option)	8
Installation Method	9
Maintenance and Inspection	10
After-Sales Service	11
Disposal	12
Specification	13
Menu list	APP A
Installation Drawings	APP B
Error due to the deviation from the irradiation angle reference value	APP C
Spare Parts List	APP D

● Safety Cautions ●

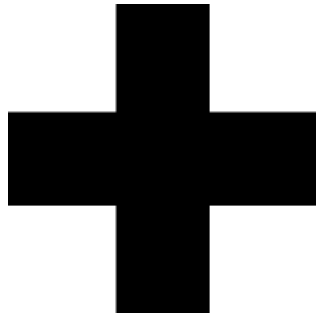

Cautions for High Voltage

High voltage of hundreds volts is used inside this equipment. Touching a component inside the unit is very dangerous. Any person other than specialized maintenance staffs should not maintain, inspect, or adjust the unit.

High voltages on the order of tens of thousand volts are most likely to cause instant deaths from electrical shocks. At times, even voltages on the order of several hundred volts could lead to electrocution. To defend against electrical shock hazards, do not put your hand into the inside of apparatus.

When you put in a hand unavoidably in case of urgent, it is strongly suggested to turn off the power switch and allow the capacitors, etc. to discharge with a wire having its one end positively grounded to remove residual charges. Before you put your hand into the inside of apparatus, make sure that internal parts are no longer charged. Extra protection is ensured by wearing dry cotton gloves at this time. Another important precaution to observe is to keep one hand in your pocket at a time, instead of using both hands at the same time. It is also important to select a secure footing to work on, as the secondary effects of electrical shock hazards can be more serious. In the event of electrical shocks, disinfect the burnt site completely and obtain medical care immediately.

Precautions for Rescue of Victim of Electric Shock

When a victim of electric shock is found, turn off the power source and ground the circuit immediately. If this is impossible, move the victim away from the unit as quick as possible without touching him or her with bare hands. He or she can safely be moved if an insulating material such as dry wood plate or cloth is used.

It is necessary to perform first aid immediately.

Breathing may stop if current flows through the respiration center of brain due to electric shock. If the electric shock is not large, breathing can be restored by artificial respiration. A victim of electric shock looks pale and his or her pulse may become very weak or stop, resulting in unconsciousness and rigidity at worst.

● Emergency Measures ●

Method of First-Aid Treatment

☆ Precautions for First-Aid Treatments

Apply artificial respiration to the person who collapsed, minimizing moving as much as possible avoiding risks. Once started, artificial respiration should be continued rhythmically.

- (1) Refrain from touching the patient carelessly as a result of the accident; the first-aiders could suffer from electrical shocks by himself or herself.
- (2) Turn off the power calmly and certainly, and move the patient apart from the cable gently.
- (3) Call or send for a physician or ambulance immediately, or ask someone to call doctor.
- (4) Lay the patient on the back, loosening the necktie, clothes, belts and so on.
- (5)
 - (a) Feel the patient's pulse.
 - (b) Check the heartbeat by bringing your ear close to the patient's heart.
 - (c) Check for respiration by bringing your face or the back of your hand to the patient's face.
 - (d) Check the size of patient's pupils.
- (6) Opening the patient's mouth, remove artificial teeth, cigarettes, chewing gum, etc. if any. With the patient's mouth open, stretch the tongue and insert a towel or the like into the mouth to prevent the tongue from being withdrawn into the throat. (If the patient clenches the teeth so tight that the mouth won't open, use a screwdriver or the like to force the mouth open and then insert a towel or the like into the mouth.)
- (7) Wipe off the mouth to prevent foaming mucus and saliva from accumulating.

Flow of Cardiopulmonary Resuscitation (CPR)

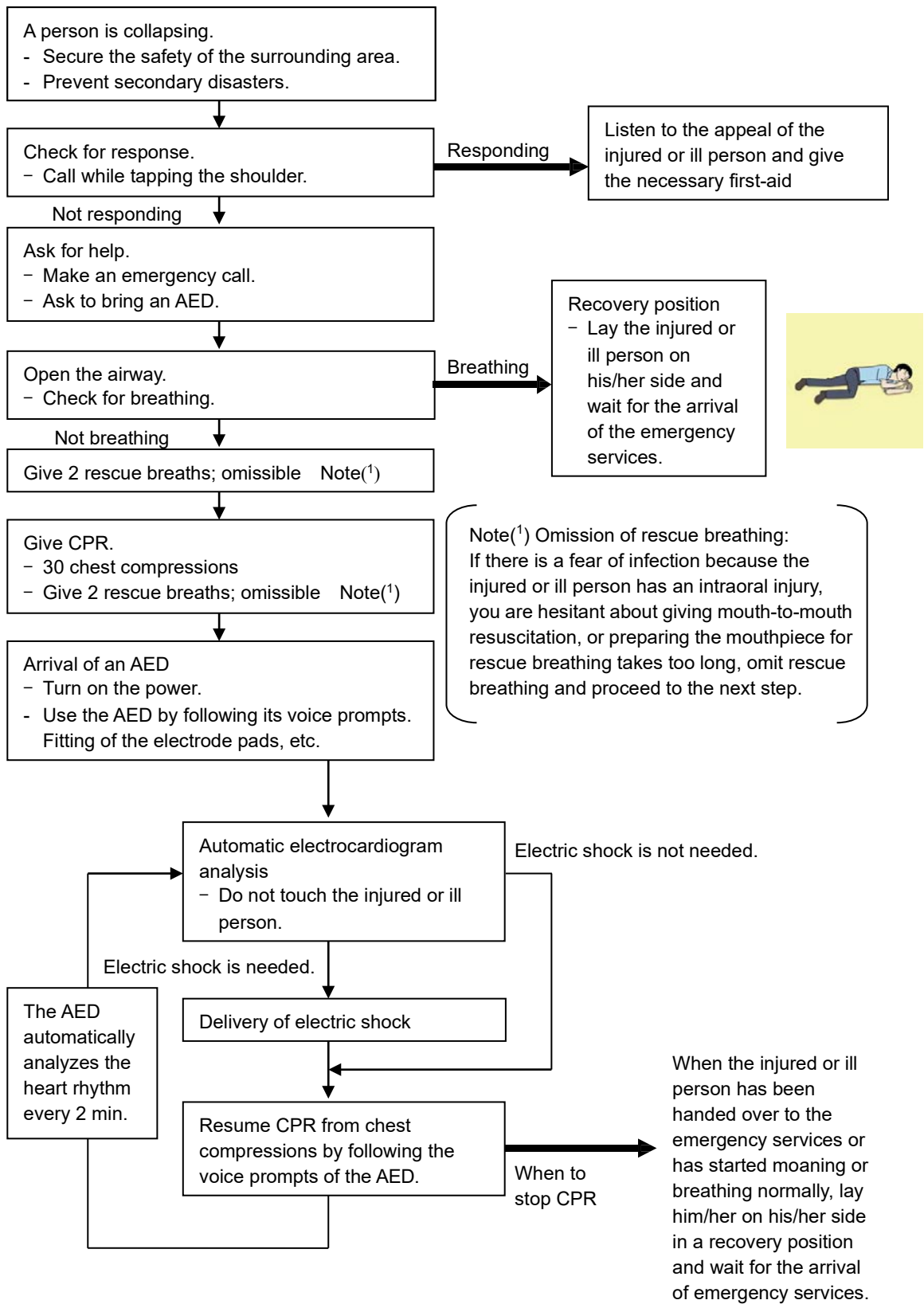

Specific Procedures for Cardiopulmonary Resuscitation (CPR)

1. Check the scene for safety to prevent secondary disasters

- Do not touch the injured or ill person in panic when an accident has occurred. (Doing so may cause electric shock to the first-aiders.)
- Do not panic and be sure to turn off the power. Then, gently move the injured or ill person to a safe place away from the electrical circuit.

2. Check for responsiveness

- Tap the shoulder of the injured or ill and shout in the ear saying, "Are you OK?"
- If the person opens his/her eyes or there is some response or gesture, determine it as "responding." But, if there is no response or gesture, determine it as "not responding."



3. If responding

- Give first-aid treatment.

4. If not responding

- Ask for help loudly. Ask somebody to make an emergency call and bring an AED.

- **Somebody has collapsed. Please help.**
- **Please call an ambulance.**
- **Please bring an AED.**
- If there is nobody to help, call an ambulance yourself.

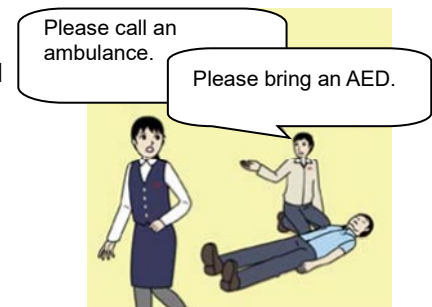

5. Open the airway

- Touch the forehead with one hand. Lift the chin with the two fingers of the middle finger and forefinger of the other hand and push down on the forehead as you lift the jaw to bring the chin forward to open the airway. If neck injury is suspected, open the airway by lifting the lower jaw.

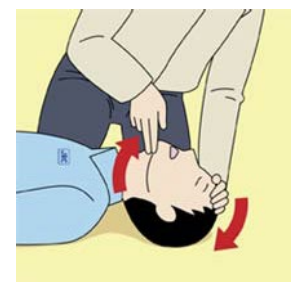

6. Check for breathing

- After opening the airway, check quickly for breathing for no more than 10 seconds. Put your cheek down by the mouth and nose area of the injured or ill person, look at his/her chest and abdomen, and check the following three points.

- Look to see if the chest and abdomen are rising and falling.
- Listen for breathing.
- Feel for breath against your cheek.

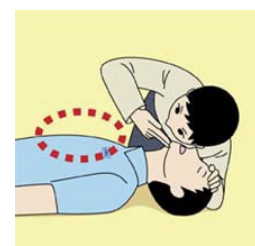

- b) If the injured or ill person is breathing, place him/her in the recovery position and wait for the arrival of the emergency services.
- Position the injured or ill person on his/her side, maintain a clear and open airway by pushing the head backward while positioning their mouth downward. To maintain proper blood circulation, roll him/her gently to position them in the recovery position in the opposite direction every 30 minutes.

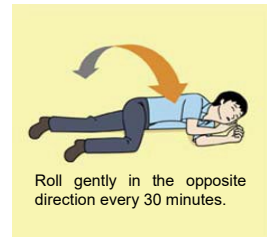

7. Give 2 rescue breaths (omissible)

- a) If opening the airway does not cause the injured or ill person to begin to breathe normally, give rescue breaths.
- b) If there is a fear of infection because the injured or ill person has an intraoral injury, you are hesitant about giving mouth-to-mouth resuscitation, or getting and preparing the mouthpiece for rescue breathing takes too long, omit rescue breathing and perform chest compressions.
- c) When performing rescue breathing, it is recommended to use a mouthpiece for rescue breathing and other protective devices to prevent infections.
- d) While maintaining an open airway, pinch the person's nose shut with your thumb and forefinger of the hand used to push down the forehead.
- e) Open your mouth widely to completely cover the mouth of the injured or ill person so that no air will escape. Give rescue breathing **twice in about 1 second** and check if the chest rises.

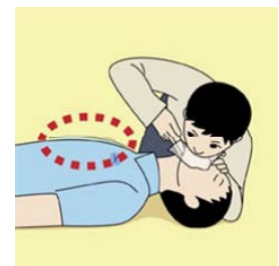

8. Cardiopulmonary resuscitation (CPR) (combination of chest compressions and rescue breaths)

- a) Chest compressions
- 1) Position of chest compressions
- Position the heel of one hand in the center of the chest, approximately between the nipples, and place your other hand on top of the one that is in position.

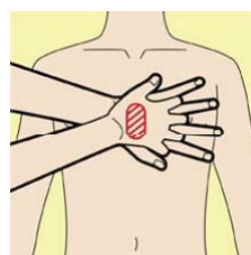
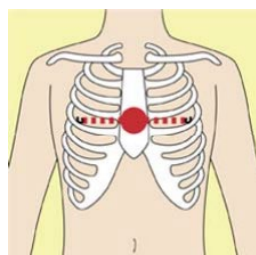

2) Perform chest compressions

- Perform uninterrupted chest compressions of **30** at the rate of about **100 times** per minute.

While locking your elbows positioning yourself vertically above your hands.

- With each compression, depress the chest wall to a depth of approximately **4 to 5 cm**.

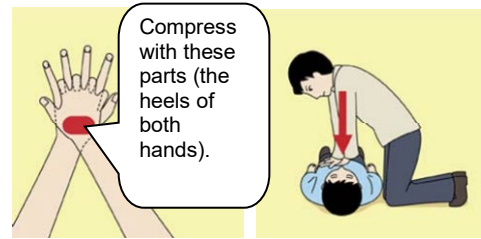

b) Combination of **30** chest compressions and **2** rescue breaths

- 1) After performing **30** chest compressions, give **2** rescue breaths. If rescue breathing is omitted, perform only chest compressions.
- 2) Continuously perform the combination of **30** chest compressions and **2** rescue breaths without interruption.
- 3) If there are two or more first-aiders, alternate with each other approximately every **two minutes** (five cycles of compressions and ventilations at a ratio of 30:2) without interruption.

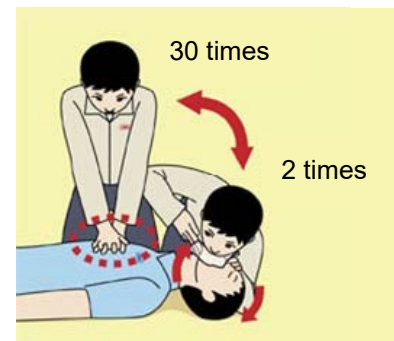

9. When to stop cardiopulmonary resuscitation (CPR)

- a) When the injured or ill person has been handed over to the emergency services
- b) When the injured or ill person has started moaning or breathing normally, lay him/her on his/her side in a recovery position and wait for the arrival of emergency services.



10. Arrival and preparation of an AED

- a) Place the AED at an easy-to-use position. If there are multiple first-aiders, continue CPR until the AED becomes ready.
- b) Turn on the power to the AED unit.
Depending on the model of the AED, you may have to push the power on button, or the AED automatically turns on when you open the cover.
- c) Follow the voice prompts of the AED.

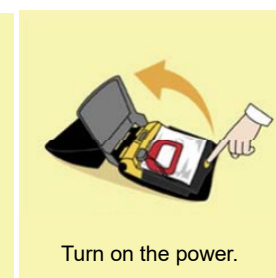

11. Attach the electrode pads to the injured or ill person's bare chest

- Remove all clothing from the chest, abdomen, and arms.
- Open the package of electrode pads, peel the pads off and securely place them on the chest of the injured or ill person, with the adhesive side facing the chest. If the pads are not securely attached to the chest, the AED may not function. Paste the pads exactly at the positions indicated on the pads. If the chest is wet with water, wipe dry with a dry towel and the like, and then paste the pads. If there is a pacemaker or implantable cardioverter defibrillator (ICD), paste the pads at least 3cm away from them. If a medical patch or plaster is present, peel it off and then paste the pads. If the injured or ill person's chest hair is thick, paste the pads on the chest hair once, peel them off to remove the chest hair, and then paste new pads.
- Some AED models require to connect a connector by following voice prompts.
- The electrode pads for small children should not be used for children over the age of 8 and for adults.

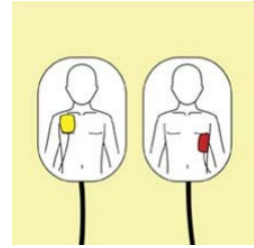

12. Electrocardiogram analysis

- The AED automatically analyzes electrocardiograms. Follow the voice prompts of the AED and ensure that nobody is touching the injured or ill person while you are operating the AED.
- On some AED models, you may need to push a button to analyze the heart rhythm.



13. Electric shock (defibrillation)

- If the AED determines that electric shock is needed, the voice prompt saying, "Shock is needed" is issued and charging starts automatically.
- When charging is completed, the voice prompt saying, "Press the shock button" is issued and the shock button flashes.
- The first-aider must get away from the injured or ill person, make sure that no one is touching him/her, and then press the shock button.
- When electric shock is delivered, the body of the injured or ill person may jerk.

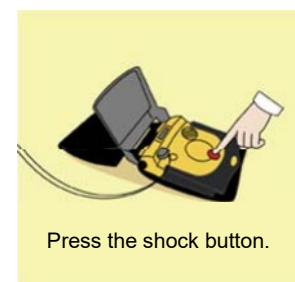

14. Resume cardiopulmonary resuscitation (CPR).

Resume CPR consisting of **30** chest compressions and **2** rescue breaths by following the voice prompts of the AED.



15. Automatic electrocardiogram analysis

- a) When **2 minutes** have elapsed since you resumed cardiopulmonary resuscitation (CPR), the AED automatically analyzes the electrocardiogram.
- b) If you suspended CPR by following voice prompts and AED voice prompt informs you that shock is needed, give electric shock again by following the voice prompts.
If AED voice prompt informs you that no shock is needed, immediately resume CPR.

16. When to stop CPR (Keep the electrode pads on.)

- a) When the injured or ill person has been handed over to the emergency services
- b) When the injured or ill person has started moaning or breathing normally, lay him/her on his/her side in a recovery position and wait for the arrival of emergency services.

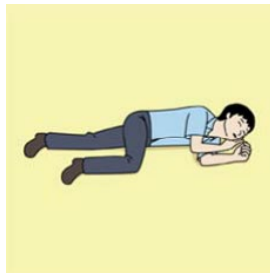

Contents

Safety Cautions	i
Emergency Measures	ii
Contents	ix
Preface	xv
Pictorial Indication	xvi
Usage Precautions	xvii
JLN-740A Overview of standard components	xxiii
JLN-740N Overview of standard components	xxiv
JLN-741A Overview of standard components	xxv
JLN-741N Overview of standard components	xxvi
Abbreviations	xxvii
Glossary	xxix
How to use this manual	xxxix
Chapter 1 General	1-1
1.1 Functions	1-1
1.2 Features	1-2
1.3 Components	1-4
1.4 Construction	1-8
1.5 System Configuration	1-18
1.5.1 JLN-740A System Configuration Diagram	1-18
1.5.2 JLN-740N System Configuration Diagram	1-19
1.5.3 JLN-741A System Configuration Diagram	1-20
1.5.4 JLN-741N System Configuration Diagram	1-21
Chapter 2 Function of Each Components	2-1
2.1 Main Display NWZ-510SDW (For JLN-740A/741A)	2-1
2.2 Main Display NWZ-4640 (For JLN-740N/741N)	2-2
2.3 Remote Display (Optional) NWZ-650SDR/840SDR	2-3
2.4 MID (Optional) NWZ-4610	2-4
2.5 Distance Counter (Optional) NWW-7	2-5
Chapter 3 Operation Method (JLN-740A/741A)	3-1
3.1 Basic Operation	3-2
3.1.1 Power Supply ON/OFF	3-2
3.1.2 Adjusting Brightness	3-4
3.2 Displaying Ship Speed/Accumulated Sailing Distance	3-5
3.2.1 Displaying Ship Speeds	3-5
3.2.2 Displaying the Accumulated Sailing Distance	3-6
3.3 Displaying Alert	3-8
3.3.1 General state transition of the Alerts	3-6

Chapter 4	Setting by Using Menus (JLN-740A/741A)	4-1
4.1.	Setting of NWZ-510SDW	4-2
4.1.1.	Main Menu	4-2
4.1.2.	Common Operation of Each Menu	4-4
4.1.3.	Operation of Each Menu	4-5
4.1.3.1.	Touch Position Calibration	4-5
4.1.3.2.	Maintenance Information	4-7
4.1.3.3.	Brightness Adjustment	4-8
4.1.3.4.	Date Setting	4-9
4.1.3.5.	Confirming the system information	4-11
4.1.3.6.	Advanced Settings of the details of the equipment at installation of this equipment	4-12
4.1.3.7.	Setting the number of decimal digits of a ship speed	4-12
4.1.3.8.	Ship Speed Unit Settings	4-13
4.1.3.9.	Set speed limit and bubble detect level	4-14
4.1.3.9.1.	Setting the upper limit and the lower limit for ship speed notice	4-14
4.1.3.9.2.	Setting the bubble detect level	4-16
4.1.3.10.	SDME Advanced Settings	4-17
4.1.3.11.	Alert List	4-17
4.1.3.12.	Alert History	4-18
4.2.	Alert	4-19
4.2.1.	JLN-740A Alert list	4-19
Chapter 5	Operation Method (JLN-740N/741N)	5-1
5.1	Basic Operation	5-2
5.1.1	Power Supply ON/OFF	5-2
5.1.2	Adjusting Brightness	5-4
5.2	Displaying Ship Speed/Accumulated Sailing Distance	5-5
5.2.1	Displaying Ship Speeds	5-5
5.2.2	Displaying the Accumulated Sailing Distance	5-6
5.3	Displaying Alert	5-7
Chapter 6	Setting by Using Menus (JLN-740N/741N)	6-1
6.1.	Setting NWZ-4640	6-2
6.1.1.	Calling a main menu	6-2
6.1.2.	Common operations of menus screens	6-4
6.1.3.	Operation of each menu	6-5
6.1.3.1.	Display setting	6-5
6.1.3.1.1.	Adjusting contrast	6-5
6.1.3.1.2.	Adjusting back light	6-6
6.1.3.1.3.	Setting a click sound	6-6
6.1.3.1.4.	Setting a display screen	6-7
6.1.3.1.4.1.	STEP1 Selecting a display screen	6-8

6.1.3.1.4.2. STEP2	Selecting a screen structure	6-9
6.1.3.1.4.3. STEP3	Selecting display contents	6-11
6.1.3.1.5.	Select a back light color	6-14
6.2.	System setting	6-15
6.3.	Language setting	6-15
6.4.	Alert setting	6-15
6.5.	Sensor setting	6-16
6.6.	Date and time setting	6-16
6.7.	Alert history display	6-16
6.8.	Alert list display	6-17
6.9.	Bubble settings display	6-17
6.10.	MAINT INFO display	6-17
6.11.	Alert	6-18
6.11.1	General State transition of the alerts	6-18
6.11.2	Alerts that occur in JLN-741N	6-19
6.12	Display of alert list · history screen	6-20
6.13.	Installation setting	6-21
6.13.1	System setting	6-21
6.13.2	Language setting	6-22
6.13.3	Sensor setting	6-22
6.13.4	Date setting	6-22
Chapter 7	Operation Method (Option)	7-1
7.1	Basic Operation	7-2
7.1.1	Adjusting Brightness	7-2
7.2	Displaying Ship Speed/Accumulated Sailing Distance	7-4
7.2.1	Displaying Ship Speeds	7-4
7.2.2	Displaying the Accumulated Sailing Distance	7-5
7.3	Displaying Alert	7-8
Chapter 8	Setting by Using Menus (Option)	8-1
8.1.	Setting of NWZ-650SDR/840SDR	8-2
8.1.1.	Main Menu	8-2
8.1.2.	Operation of Each Menu	8-4
8.1.2.1.	Touch Position Calibration	8-4
8.1.2.2.	Brightness Adjustment	8-5
8.1.2.3.	Date Setting	8-6
8.1.2.4.	Confirming the system information	8-8
8.1.2.5.	Advanced Settings of the details of the equipment at installation of this equipment	8-9
8.1.2.6.	Display Mode Selection	8-9
8.1.2.7.	Ship Speed Unit Settings	8-10
8.1.2.8.	SDME Advanced Settings	8-11
8.1.2.9.	SOG and STW selection	8-12

8.2. Setting of NWZ-4610	8-12
Chapter 9 Installation Method	9-1
9.1 Installation of the Main Display and Distribution Processor	9-2
9.2 Installation of the Transducer Mounting	9-3
9.3 Connection Diagram	9-4
9.3.1 JLN-740A inter-connection diagram	9-4
9.3.2 JLN-740N inter-connection diagram.....	9-5
9.3.3 JLN-741A inter-connection diagram	9-6
9.3.4 JLN-741N inter-connection diagram.....	9-7
Chapter 10 Maintenance and Inspection	10-1
10.1 Routine Maintenance	10-1
10.2 Countermeasures for Abnormalities and Faults	10-2
10.3 Repair unit.....	10-2
10.4 Troubleshooting	10-3
10.5 Maintenance information	10-6
Chapter 11 After-Sales Service.....	11-1
11.1 Requesting Repair	11-1
11.2 Recommendation of Inspection and Maintenance	11-2
Chapter 12 Disposal.....	12-1
Chapter 13 Specification	13-1
13.1. General Specification.....	13-1
13.1.1. JLN-740A	13-1
13.1.2. JLN-740N.....	13-1
13.1.3. JLN-741A	13-2
13.1.4. JLN-741N.....	13-2
13.2. JLN-740A/741A Main Display NWZ-510SDW.....	13-3
13.2.1. Display Unit.....	13-3
13.2.2. Electrical Specifications	13-3
13.2.3. Environmental Requirements	13-3
13.2.4. Mechanical Specifications	13-3
13.2.5. External Interface.....	13-4
13.3. JLN-740N/741N Main Display NWZ-4640	13-5
13.3.1. Display Unit.....	13-5
13.3.2. Electrical Specifications	13-5
13.3.3. Environmental Requirements	13-5
13.3.4. Mechanical Specifications	13-5
13.3.5. External interface.....	13-5
13.4. Distribution Processor NQA-7040	13-6
13.4.1. Electrical Specifications	13-6
13.4.2. Environmental Requirements	13-6
13.4.3. Mechanical Specifications	13-6
13.4.4. External Interface.....	13-6

13.5. Signal Processor NJC-70S	13-7
13.5.1. Electrical Specifications	13-7
13.5.2. Environmental Requirements	13-7
13.5.3. Mechanical Specifications	13-7
13.6. Transducer mounting NKF-547	13-8
13.6.1. Electrical Specifications	13-8
13.6.2. Environmental Requirements	13-8
13.6.3. Mechanical Specifications	13-8
13.7. Transducer mounting (Option) NKF-531E	13-9
13.7.1. Electrical Specifications	13-9
13.7.2. Environmental Requirements	13-9
13.7.3. Mechanical Specifications	13-9
13.8. Remote Display (Optional) NWZ-650SDR	13-10
13.8.1. Display Unit.....	13-10
13.8.2. Electrical Specifications	13-10
13.8.3. Environmental Requirements	13-10
13.8.4. Mechanical Specifications	13-10
13.9. Remote Display (Optional) NWZ-840SDR	13-11
13.9.1. Display Unit.....	13-11
13.9.2. Electrical Specifications	13-11
13.9.3. Environmental Requirements	13-11
13.9.4. Mechanical Specifications	13-11
13.10. MID (Optional) NWZ-4610	13-12
13.10.1. Display Unit	13-12
13.10.2. Electrical Specifications.....	13-12
13.10.3. Environmental Requirements	13-12
13.10.4. Mechanical Specifications	13-12
13.11. JLN-740A/N Data Format.....	13-13
13.11.1. IEC 61162-1 Input/Output Data	13-13
13.11.1.1. Output data	13-13
13.11.1.2. Input data	13-16
13.11.2. IEC 61162-450 I/F	13-19
13.12. JLN-741A/N Data Format.....	13-20
13.12.1. IEC 61162-1 Output Data	13-20
13.12.1.1. Output data	13-20
13.12.1.2. Input data	13-23
13.13. About Chinese version RoHS	13-22
Appendix A Menu list	A-1
A.1 Display menu list (NWZ-510SDW, NWZ-650SDR/NWZ-840SDR).....	A-1
A.2 Display menu list (NWZ-4640).....	A-6
A.3 Maintenance software menu list.....	A-10
Appendix B Installation Drawings	B-1

Appendix C	Error due to the deviation from the irradiation angle reference value	C-1
C.1	Errors by hull motions	C-1
Appendix D	Spare Parts List.....	D-1

Preface

Thank you for purchasing the Japan Radio Co., Ltd.

JLN-740A/740N/741A/741N Doppler Log. This equipment is an SDME (Speed and Distance Measuring Equipment), complying with the regulations of IMO (International Marine Organization), measures and displays wide-range ship speed through the water.



- Please read all safety precautions, pictorial indication and manual carefully before using your equipment to ensure safe and proper use.
- Please keep this instruction manual handy for future reference. Doing so will allow you to understand and to be prepared for any contingency.

● Pictorial Indication ●

Meanings of Pictorial Indication

Various pictorial indications are included in this manual and are shown on this equipment so that you can operate them safely and correctly and prevent any danger to you and / or to other persons and any damage to your property during operation. Such indications and their meanings are as follows.

Please understand them before you read this manual:

	DANGER	This indication is shown where incorrect equipment operation due to negligence may cause death or serious injuries.
	WARNING	This indication is shown where user is supposed to be in danger of being killed or seriously injured if this indication is neglected and this equipment is not operated correctly.
	CAUTION	This indication is shown where user is supposed to be injured or any property damage is supposed to occur if this indication is neglected and this equipment is not operated correctly.

Examples of Pictorial Indication



Electric Shock

The △ mark represents CAUTION (including DANGER and WARNING).

Detailed contents of CAUTION ("Electric Shock" in the example on the left) is shown in the mark.



Disassembling
Prohibited



The ⊘ mark represents prohibition.

Detailed contents of the prohibited action ("Disassembling Prohibited" in the example on the left) is shown in the mark.



Disconnect
the power plug



The ● mark represents instruction.

Detailed contents of the instruction ("Disconnect the power plug" in the example on the left) is shown in the mark.

Warning Label



There is a warning label on the top cover of the equipment. Do not try to remove, break or modify the label.

● Usage Precautions ●

DANGER



Never remove the cover of this equipment.
Touching the high-voltage section inside may cause an electric shock.



Before conducting inspection, maintenance or parts replacement, make sure to turn off the power and breaker.

Failure to comply may cause an electric shock, fire or an equipment fault. Make sure to turn the breaker off since voltage is still outputted from the distribution processor even after the displays are turned off.

Failure may result in equipment failure, or death or serious injury due to electric shock.



Do not touch the equipment with hands or gloves wet with water.
Otherwise, an electric shock or a malfunction may occur.

WARNING



Customers shall never attempt to check or repair the inner of the equipment. Checking or repair by an unqualified person may cause a fire or an electric shock.



Do not attempt to disassemble or tamper with this equipment. A fire, an electric shock, or a malfunction may occur.



For maintenance, inspection of the internal section of the equipment, request the service to the store, nearest JRC agent, JRC marine service department, sales department, regional office, branch or sales office.



In case you find smoke, unusual odor or extreme high heat coming from the equipment, turn off the power and breaker immediately, unplug the power supply cable from an electric outlet, and contact the store, nearest JRC agent, JRC marine service department, sales department, regional office, branch or sales office.

Keeping the equipment in operation under such condition may cause fire or an electric shock.



The Doppler log must be used strictly as navigation aid equipment only. The final decision on navigation must be made by the pilot. If the final decision is made based on the information displayed by the Doppler log only, an accident such as collision or grounding may occur.



This equipment must not be used by anyone except the ship's crews and specialized maintenance staff. Failure to comply may result in misuse.



Do not use this equipment under any power supply voltage other than the voltage that is indicated. Failure to comply may result in fire, an electric shock, or an equipment fault.



Do not place a glass or cup containing water, etc., or a small metal object on this equipment. If water or such object gets inside, a fire, an electric shock, or a malfunction may occur.

WARNING



In case water or a metal object gets inside the equipment, turn off the power and the breaker immediately, unplug the power supply cable from an electric outlet, and contact the store, nearest JRC agent, JRC marine service department, sales department, regional office, branch or sales office. Keeping the equipment in operation under such condition may cause a fire, an electric shock or a malfunction.



Always turn off the power and breaker before inserting/removing this equipment or the connector of the connection cable with the external equipment.
Failure to comply may result in fire or an equipment fault.



Do not touch the power supply cable or circuit cable during severe thunder.
Failure to comply may result in an electric shock.



When the power cable is damaged (exposed cable conductor, broken cable, or torn capsule), request replacement to the store, nearest JRC agent, JRC marine service department, sales department, regional office, branch or sales office.
Using the cable as it is may result in fire or an electric shock.



Do not apply strong shock to the power supply cable or the LAN cable by striking it or hammering it.
Otherwise, an open circuit failure may result.



Make sure using the specified fuses.
Otherwise, fire or an equipment fault may occur.



Before exchanging fuses of this equipment, the equipment must be switch off and the AC/DC input must be cut off



When installing the cable that comes with the transducer mounting, make sure that the cable is not tightly bent, or twisted, and that no pressure is applied to the cable.
Otherwise, the cable may crack or the inside of the covering may be damaged, causing a fire or an electric shock.



Do not perform installation or maintenance to the transducer mounting on the water.
Otherwise, water may get into the transducer mounting.

CAUTION



Electrical work for this equipment must be requested to the store, nearest JRC agent, JRC marine service department, sales department, regional office, branch or sales office.

Conducting electrical work by anyone other than specialized maintenance staff may result in an accident or an equipment fault.



Use the screws that are specified in the installation manual when installing this equipment.

Use of any other screws may result in an injury or an equipment failure caused by the equipment dropping down.



Use the specified power supply cables, signal cables, and earth cables.

Failure to comply may cause faults in some other equipment or cause this equipment to become susceptible to faults from some other equipment.



Distribution processor and signal processor are wall mount only.

Please do not set it other than wall mount.

There is a fear of malfunction.



When mounting the equipment on the wall, mount it firmly to avoid the equipment from dropping under its own weight.

Failure to comply may result in an injury caused by the dropping equipment.



When installing this equipment, make sure that the equipment is connected to the earth terminal and the earth plate properly.

Failure to comply may results in an electric shock at an equipment fault or an electric leakage.



Do not place this equipment inside of a cupboard or cover it with a cardboard.

Failure to comply may cause heat accumulation, resulting in fire or an equipment fault.



Do not block the ventilation opening of the equipment.

Otherwise, heat may accumulate inside to cause a fire or a malfunction.



Do not place this equipment in water or wet this equipment.

Failure to comply may result in an electric shock or an equipment malfunction.

If water drops are attached to this equipment, wipe them off with a dry cloth.



Do not place any object on the operation panel.

In particular, if a hot object is placed on the operation panel, it can cause deformation of the surface of the operation panel.

CAUTION



Do not use the equipment in environments other than those provided in the specifications.
Doing so may result in equipment failure, malfunction, or injury.



Do not use or leave the equipment under direct sunlight for a long time or in the temperatures above 55°C.
Otherwise, fire or a malfunction may occur.



Do not install the equipment in a place under the influence of water, humidity, vapor, dust or soot.
Failure to comply may result in fire, an electric shock, or an equipment malfunction.



Do not place this equipment in a location under the influence of frequent vibrations or impact.
Failure to comply may cause the equipment to drop or fall over, resulting an injury or an equipment fault.



This equipment may not satisfy the desired performance and functionality when it is installed other than ships.
Because this product is designed to be installed for ship.



Adjustments must be made by specialized service technicians.
Incorrect settings may result in unstable operation, and this may lead to accidents or equipment failure.



Do not rotate the semi-fixed resistor and trimmer capacitor that are installed in its equipment since they have been adjusted to the exact positions.
Failure to comply may result in an equipment fault or malfunctioning.



Do not apply any undue shock on the operation panel.
Otherwise, a malfunction may result.



When cleaning the display screen, do not wipe it too strongly with a dry cloth.
Also, do not use gasoline or thinner to clean the screen.
Failure will result in damage to the screen surface.

CAUTION



Adjust the brightness of the display according to the surrounding lighting conditions.

In NWZ-510SDW, the using of [NIGHT] may interfere with the recognition of display information.

In NWZ-4640, the using of [DARK] may interfere with the recognition of display information.



Do not carry out operation of touch panel by a sharp object.

Otherwise, the screen may be damaged.



If power outage occurs inside of the ship during the operation of the Doppler log, the image may be disturbed or may not be displayed.

In this case, reconnect the power supply.



Do not turn on the power for the equipment while the ship is out of the water (grounded).

Otherwise, the transducer mounting may be damaged.

JLN-740A Overview of standard components



NWZ-510SDW JLN-740A Main Display



NJC-70S Signal Processor

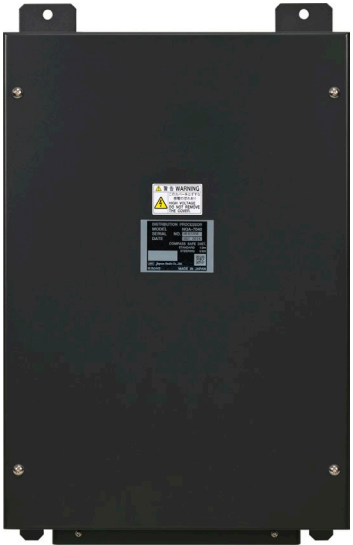

NQA-7040 Distribution Processor



NKF-547 Transducer Mounting

JLN-740N Overview of standard components



NWZ-4640 JLN-740N Main Display



NJC-70S Signal Processor

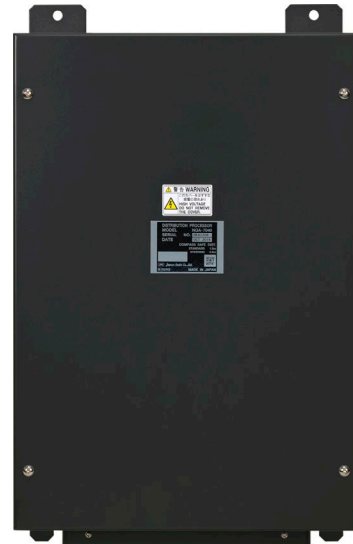

NQA-7040 Distribution Processor



NKF-547 Transducer Mounting

JLN-741A Overview of standard components



NWZ-510SDW JLN-741A Main Display



NJC-70S Signal Processor



NKF-547 Transducer Mounting

JLN-741N Overview of standard components



NWZ-4640 JLN-741N Main Display



NJC-70S Signal Processor



NKF-547 Transducer Mounting

Abbreviations

This section describes the main abbreviations that are used for this equipment and related general nautical terms.

AC	Alternating Current
ACK	Acknowledge
ADV	Advanced (Settings)
AED	Automated External Defibrillator
AFT	After
ALM	Alarm
approx.	approximate(ly)
AUTO	Automatic
bps	Bit per Second
BUZZ	Buzzer
CAL	Calibrate
CALC	Calculation
CAM	Central Alert Management
CH	Channel
COMM	Communication
CPR	Cardiopulmonary Resuscitation
Ctrl	Control
CV	Caution Active Unacknowledged
DC	Direct Current
DDC	Display Dimming Control
DIM	Dimmer
DISP	Display
DP	Distribution Processor
EL	Electroluminescence
EMC	Electromagnetic Compatibility
ERR	Error
FG	Frame Ground
FORE	Fore
FPGA	Field-Programmable Gate Array
G	Standard Acceleration of Gravity
GND	Ground
GNSS	Global Navigation Satellite System
GPS	Global Positioning System
HBT	Heart Beat
HIST	History
HW	Hardware
ICD	Implantable Cardioverter Defibrillator
ID	Identification
IEC	International Electrotechnical Commission
IMO	International Maritime Organization
IP	International Protection
IP	Internet Protocol (Address)
kn (Current notation)	knot

kt (Old notation)	knot
LAN	Local Area Network (Cable)
LANG.	Language
LCD	Liquid Crystal Display
MF	Multi-Function Display
MID	Multi-information Display
min	minute(s)
MIS	Mismatch
NM	Nautical Mile
NMEA	National Marine Electronics Association
No.	Number
P	Pulse
PA	Power Amplifiers
PC	Personal Computer
Proc	Processor
PSTBD	Port-Starboard
RAM	Random Access Memory
RECV	Receive
REM	Remains
ROM	Read Only Memory
RMS	Remote Maintenance System
RN	Rectified Normal
Rx RX	Receive/Receiver
SAT	Satellite
SDME	Speed and Distance Measuring Equipment
Ser.	Serrial Number
SET	Settings
SOG	Speed Over the Ground
SP	Signal Processor
STD	Standard
STW	Speed Through Water
SW	Switch
Tx TX	Transmit/Transmitter
VBW	Dual Ground/Water Distance (NMEA-Standard Sentence)
VDR	Voyage Data Recorder
Ver.	Version
VLW	Dual Ground/Water Distance (NMEA-Standard Sentence)
WA	Warning Active Acknowledged
WARN	WARNING
WV	Warning Active Unacknowledged

Glossary

This section describes the main terms that are used for this equipment.

IEC 60945	Maritime navigation and radiocommunication equipment and systems – General requirements– Methods of testing and required test results
IEC 61023	Maritime navigation and radiocommunication equipment and systems – Marine speed and distance measuring equipment (SDME) – Performance requirements, methods of testing and required test results
IEC 61162	Maritime navigation and radiocommunication equipment and systems – Digital interfaces –
IEC 61162-1	Part 1: Single talker and multiple listeners
IEC 61162-2	Part 2: Single talker and multiple listeners – Ethernet interconnection
IEC 61162-450	Part 450: Multiple talkers and multiple listeners – Ethernet interconnection
IEC 62288	Maritime navigation and radiocommunication equipment and systems - Presentation of navigation-related information on shipborne navigational displays - General requirements, methods of testing and required test results
IEC62923-1 Ed1	Maritime navigation and radiocommunication equipment and systems – Bridge alert management – Part 1: Operational and performance requirements, methods of testing and required test results
IEC62923-2 Ed1	Maritime navigation and radiocommunication equipment and systems – Bridge alert management – Part 2: Alert and cluster identifiers and other additional features
IMO MSC.334(90)	IMO regulation
SVGA	Super Video Graphics Array with resolution of: 800x600 pixels
WVGA	Wide Video Graphics Array with resolution of: 800x480 pixels
VGA	Video Graphics Array with resolution of: 640x480 pixels
Active	Active-unacknowledged Unacknowledged/unrectified state after the occurrence of alert

Rectified	Rectified-unacknowledged Unacknowledged/rectified state after the occurrence of alert
Acknowledged	Active-acknowledged Acknowledged/unrectified state after the occurrence of alert
Silenced	Active-silenced Unacknowledged/unrectified and silenced state after the occurrence of alert
Responsibility transfer	Alert responsibility transfer Function that transfers alert to another equipment

How to use this manual

This manual describes the handling and operation procedures for four models, JLN-740A, JLN-740N, JLN-741A, and JLN-741N.

Read the related sections of the required model.

Model				
Contents	JLN-740A	JLN-740N	JLN-741A	JLN-741N
Overview of the equipment	P. 1-1			
Function of each component				
Main display	P. 2-1	P. 2-2	P. 2-1	P. 2-2
Operation method	P. 3-1	P. 5-1	P. 3-1	P. 5-1
Setting by using menus	P. 4-1	P. 6-1	P. 4-1	P. 6-1
(Refer to the following pages as required.)				
Function of each component				
Remote display (Optional)	P. 2-3	P. 2-3	-	-
MID (Optional)	P. 2-4	P. 2-4	-	-
Distance counter (Optional)	P. 2-5	P. 2-5	-	-
Operation method (Optional)	P. 7-1	P. 7-1	-	-
Setting by using menus (Optional)	P. 8-1	P. 8-1	-	-
Installation method	P. 9-1			
Maintenance and inspection	P. 10-1			
Aftercare service	P. 11-1			
Disposal	P. 12-1			
Specification	P. 13-1			
Appendix	P. A-1, B-1, C-1,D-1			

(This page intentionally left blank)

Chapter 1 General

1.1 Functions

The JLN-740A/740N/741A/741N Doppler log is the equipment that accurately measures the speed through the water and navigation distance of the ship by emitting ultrasonic signals to the fore and the after in the water from the transducer that is installed in the bottom of the ship and using the Doppler effects of the ultrasonic signals that are reflected from the underwater.

This equipment measures the relative speed through the water at 3m or more from the bottom of a ship. Therefore, the equipment can measure the ship speed according to the output of the main engine excluding the speed of the current and so on.

Signals surrounding the bottom of the ship are excluded by applying transmission and reception in a pulse system, thereby preventing errors of the ship speed that occurs due to the change of the draft. In addition, by using the dual beam system that emits ultrasonic signals in two directions, fore and after, the ship's speed errors due to the trim change are dramatically reduced.

This equipment complies with the IMO (International Maritime Organization) regulation and measures and displays a wide range of ship speed from low speed to high speed.

Four models are available for this equipment, JLN-740A/741A equipped with a 5-inch color display and JLN-740N/741N equipped with a 4.5-inch monochrome display.

The JLN-740A/740N model is intended for large ships and has a distribution processor that performs input/output of various signals.

The JLN-741A/741N is a limited model that is intended for small ships and performs minimum necessary signal output.

Equipment configuration		Equipment configuration			
		4 equipment configurations		3 equipment configurations	
Components	Equipment configuration	JLN-740A	JLN-740N	JLN-741A	JLN-741N
Transducer (NKF-547 or NKF-531E)		○	○	○	○
Signal processor (NJC-70S)		○	○	○	○
Distribution processor (NQA-7040)		○	○	×	×
5-inch color display (NWZ-510SDW)		○	×	○	×
4.5-inch monochrome display (NWZ-4640)		×	○	×	○

1.2 Features

This equipment has the following features.

Colour display unit with touch panel (JLN-740A/741A)

This unit has the function of displaying a ship speed and a trip distance by using a 5-inch colour display as well as the user interface function for setting various parameters.

Autonomic measurement function by an ultrasonic transducer mounting

This function measures the fore/after speed of the ship by using ultrasonic signals.

Therefore, the function can measure the ship speed relative to the sea water without any impact from the fair tide/tidal current near the bottom of the ship.

This function applies a dual beam system that sends ultrasonic signals in two directions, ahead and astern, thereby dramatically reducing the ship speed measurement errors caused by the rolling of the hull of the ship.

Digital/analog display switching function of a remote display (JLN-740A/740N)

Both analog display and digital display are supported for the remote display NWZ-640SDR/840SDR, which is available as optional.

Output sentence version switching function (JLN-740A/740N)

This function outputs VBW (ship speed information) and VLW (trip distance) sentences. IEC61162-1 is applied to the sentences as the standard. In addition, the function supports NMEA Ver.1.5, Ver.2.1, Ver.2.3, and Ver.4.0.

JLN-740A/740N supports multiple versions in the same way as the IEC61162-450 sentences of Ethernet output. The switching range is the same as that of serial output.

Remote Maintenance function (Remote Maintenance System, RMS) (JLN-740A/740N)

This function corresponds to the updating and equipment operation status checking of firmware by RMS.

Maintainability and serviceability are improved by using the RMS function.

To use this function, connection with VDR of JRC is necessary.

Alert sequence function (JLN-740A/740N/741A/741N)

This function transmits and receives alert information to the Bridge Alert Management System (BAM) and the Integrated Navigation System (INS).

This function corresponds to alert display by BAM/INS.

This function also supports Ethernet communication and serial communication.

The alert sequence function (excluding contact) complies with IMO Resolution A.1021 of IEC 61162 and IEC 62923.

Ship speed alert function (JLN-740A/740N)

This function enables the setting of an upper limit and a lower limit for the ahead/astern ship speeds by using any value.

Since an alert is issued if the ship speed exceeds any of the set values, the values can be used as the guidelines for maintaining a constant speed.

Transducer mounting damage prevention function (*under the process of patent acquisition)

This equipment prevents damage of the oscillator due to the excessive output by controlling the transmission output according to the individual differences of the oscillators within the transducer.

Transducer mounting checking function

This function can check the waveforms that are received through the transducer mounting from the bridge and the operating status of the transducer mounting by connecting a maintenance PC.

This eliminates the necessity for the shifting to the boatswain's store/bottom compartment and its ventilation, thereby reducing the time required for maintenance/service.

Bubble detection function (*under the process of patent acquisition)

Bubbles near the transducer mounting radiation face can be detected by sending bubble detection ultrasonic signals at a constant interval.

This function facilitates the detection of the cause of the missing values, which is difficult in the existing equipment.

AC power failure detection function (JLN-740A/740N)

This function outputs an alert and inputs ACK at a dedicated contact input/output when the AC power voltage drops. To operate the detection circuit, connection of DC24V is necessary.

Dimmer function (JLN-740A/740N/741N)

A dimmer function of the display unit by an external volume is supported.

Individual control/bulk control can be selected by using the display dimmer.

Applicable standards

This equipment complies with the following standards.

IMO MSC.334(90)

IEC61023 ed.3

IEC60945 ed.4

IEC61162-1 ed.4

IEC61162-450 ed.2

IEC62288 ed.2

IEC62923-1 ed.1

IEC62923-2 ed.1

1.3 Components

The standard components and optional components (separately sold) are shown in the tables below.

JLN-740A Standard components

Item name	Model	Code	Quantity	Remarks
Main Display	NWZ-510SDW	NWZ510SDW	1	5-inch color display
Main Display Communication Cable	CFS-5680	CFS5680	1	Cable for communication/power supply between the main display and distribution processor (about 1.2m)
Distribution Processor	NQA-7040	NQA7040	1	For JLN-740A/740N
LAN Plug Connector	ADT-STP-T10 ADT-MC7L	5JBDH00021 5JBDH00009	Each 2	Lan connector Modular cover
Signal Processor	NJC-70S	NJC70S	1	-
Transducer Mounting	NKF-547	NKF-547	1	Flat type With cable 30m
Spare parts	H-7ZXNA3007	7ZXNA3007	1	-
Instruction manual	H-7ZPNA3208	7ZPNA3208	1	-

JLN-740N Standard components

Item name	Model	Code	Quantity	Remarks	
Main display unit	NWZ-4640	NWZ4640	1	4.5-inch monochrome display	
NWZ-4640 Accessory	Data power cable	CFQ-5766A	CFQ5766A	1	2m
	Fuse	MF60NR 250V 1	5ZFGD00205	2	1A fuse
	Front panel	MTV305018A	MTV305018A	1	-
	Desktop frame kit	MPBX47065	MPBX47065	1	Base, Knob Bolt, rotating seat, Knob Washer
	Product nameplate	MPNN50584A	MPNN50584A	1	For Front
	Installation schematic drawing	MTZ304550A	MTZ304550A -	1	For Flush Mount
Distribution Processor	NQA-7040	NQA7040	1	For JLN-740A/740N	
LAN Plug Connector	ADT-STP-T10 ADT-MC7L	5JBDH00021 5JBDH00009	Each 2	Lan connector Modular cover	
Signal Processor	NJC-70S	NJC70S	1	-	
Transducer Mounting	NKF-547	NKF-547	1	Flat type With cable 30m	
Junction box	CQD-10	CQD-10CN2	1	-	
Spare parts	H-7ZXNA3007	7ZXNA3007	1	-	
Instruction manual	H-7ZPNA3208	7ZPNA3208	1	-	
External Buzzer (Note1)	CGC-300B	CGC300BN2	1	N2.5 For Flush Mount	
Connection Cable	CFQ-9002	CFQ-9002	1	For CGC-300B 5m	

Note1 . The external buzzer is not supported since August 2021.

JLN-741A Standard components

Item name	Model	Code	Quantity	Remarks
Main Display	NWZ-510SDW	NWZ510SDW	1	5-inch color display
Main Display Communication Cable	CFS-6680A	CFS6680A	1	Cable for communication/power supply between the main display and signal processor (about 1.2m)
Signal Processor	NJC-70S	NJC70S	1	-
AC power rectifier	NBA-5143	NBA5143A	1	-
Transducer Mounting	NKF-547	NKF-547	1	Flat type With cable 30m
Spare parts	H-7ZXNA3007	7ZXNA3007	1	-
Instruction manual	H-7ZPNA3208	7ZPNA3208	1	-

JLN-741N Standard components

Item name	Model	Code	Quantity	Remarks	
Main display unit	NWZ-4640	NWZ4640	1	4.5-inch monochrome display	
NWZ-4640 Accessory	Data power cable	CFQ-5766A	CFQ5766A	1	2m
	Fuse	MF60NR 250V 1	5ZFGD00205	2	1A fuse
	Front panel	MTV305018A	MTV305018A	1	-
	Desktop frame kit	MPBX47065	MPBX47065	1	Base, Knob Bolt, rotating seat, Knob Washer
	Product nameplate	MPNN50584A	MPNN50584A	1	For Front
	Installation schematic drawing	MTZ304550A	MTZ304550A -	1	For Flush Mount
Signal Processor	NJC-70S	NJC70S	1	-	
AC power rectifier	NBA-5143	NBA5143A	1	-	
Transducer Mounting	NKF-547	NKF-547	1	Flat type With cable 30m	
Junction Box	CQD-10	CQD-10CN2	1	-	
Spare parts	H-7ZXNA3007	7ZXNA3007	1	-	
Instruction manual	H-7ZPNA3208	7ZPNA3208	1	-	
External Buzzer (Note2)	CGC-300B	CGC300BN2	1	N2.5 For Flush Mount	
Connection Cable	CFQ-9002	CFQ-9002	1	For CGC-300B 5m	

Note2 . The external buzzer is not supported since August 2021.

JLN-740A, JLN-740N Optional components (Separately sold)

Item name	Model	Code		Quantity	Remarks
Desktop frame	MPBX49706	MPBX49706		1	For JLN-740A Main display (NWZ-510SDW)
Remote Display	NWZ-650SDR NWZ-840SDR	NWZ650SDR NWZ840SDR		2	Up to a total of 2 units
Multi-information Display (MID)	NWZ-4610	Color	Code	2	
		N2.5	NWZ4610N2		
		N4	NWZ4610		CFQ-5766A 2m attached
Distance Counter	NWW-7	Color	Code	1	A loud sound is heard when counting
		N2.5	NWW-7-N2		
		N4	NWW-7-N4		
		2.5G7/2	NWW-7		
		7.5BG7/2	NWW-7-7		
Junction Box	CQD-10	CQD-10CN2		1	-
Analog Display	NWW-24 NWW-25 NWW-26	Refer to "Table 1.1 Analog display size list".		2	NWW - 25 has built - in dimmer
Remote Display Communication Cable	CFS-6680A	CFS6680A		1	Cable for communication/power supply between the remote display and distribution processor (about 1.2m)
Multi-information Display Communication/ Power Supply Cable	CFQ-5766D	CFQ5766D		1	10m/14-core/extension
	CFQ-5766F	CFQ5766F		1	20m/14-core/extension
Transducer Mounting	NKF-531E	NKF-531E		1	Gate Valve type With cable 40 m
Dimmer Unit	NCM-227	Color	Code	1	Connection compatible devices, please refer to " Table 1.2 Control according to dimmer unit NCM-227 / NCM-329"
		N2.5	NCM-227-N2		
		N3	NCM-227-N		
		2.5G7/2	NCM-227-2		
		7.5BG7/2	NCM-227-7		
	NCM-329	Color	Code	1	
		N2.5	NCM329H-N2		
		N3	NCM-329-HN		
		2.5G7/2	NCM-329-H2		
		7.5BG7/2	NCM-329-H7		

JLN-741A, JLN-741N optional item

Item name	Model	Code	Quantity	Remarks
Desktop frame	MPBX49706	MPBX49706	1	For JLN-741A Main display (NWZ-510SDW)
Transducer Mounting	NKF-531E	NKF-531E	1	Gate valve type 40-m cable attached

Variation of NKF-531E (Classification Society) Optional components (Separately sold)

Class	Item name	Model	Code	Cable length
ABS / DNV	Transducer Mounting ABS/DNV	NKF-531EAD-04	NA531EAD04	40m
BV	Transducer Mounting BV	NKF-531EBV-04	NA531EBV04	40m
CCS	Transducer Mounting CCS	NKF-531ECC-04	NA531ECC04	40m
GL	Transducer Mounting GL	NKF-531EGL-04	NA531EGL04	40m
KR	Transducer Mounting KR	NKF-531EKR-04	NA531EKR04	40m
LR	Transducer Mounting LR	NKF-531ELR-04	NA531ELR04	40m
NK	Transducer Mounting	NKF-531E	NA531ENK	25m

Variation of CFT-022 (Transducer without Gate Valve) Optional components (Separately sold)

Item name	Model	Code	Cable length
2 MHz Transducer	CFT-022C30	CFT022C30	30m
Painting Transducer	CFT022C30P	CFT022C30P	30m
2 MHz Transducer	CFT-022C01	CFT022C01	40m

Note: CFT022C30P is a specification for JMU

Variation of CFT-023 (Transducer for Gate Valve) Optional components (Separately sold)

Item name	Model	Code	Cable length
2 MHz Transducer	H-7UNNA3002 CFT-023C	7UNNA3002	25m
2 MHz Transducer	CFT023C01	CFT023C01	40m

Variation of Data Power Cable for NWZ-4610 Optional components (Separately sold)

Item name	Model	Code	Cable length
DATAPOWER CABLE	CFQ-5766B	CFQ5766B	3m
DATAPOWER CABLE	CFQ-5766D	CFQ5766D	10m
DATAPOWER CABLE	CFQ-5766F	CFQ5766F	20m

1.4 Construction

This section provides the externals charts of the system components.

Main display unit NWZ-510SDW for JLN-740A/741A

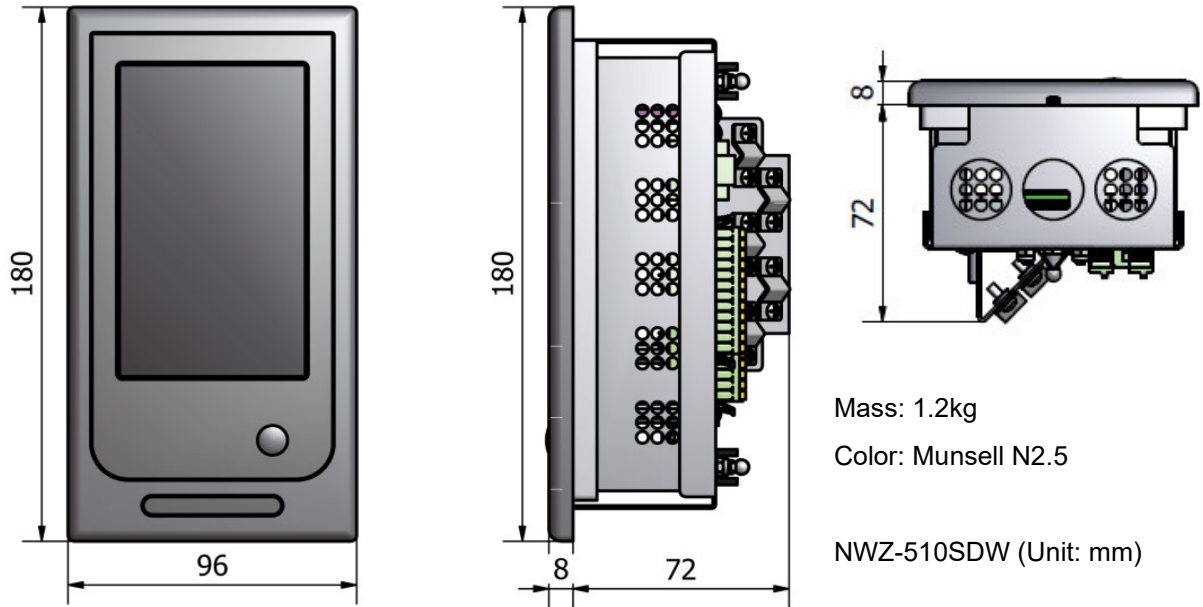

Main display unit NWZ-4640 for JLN-740N/741N

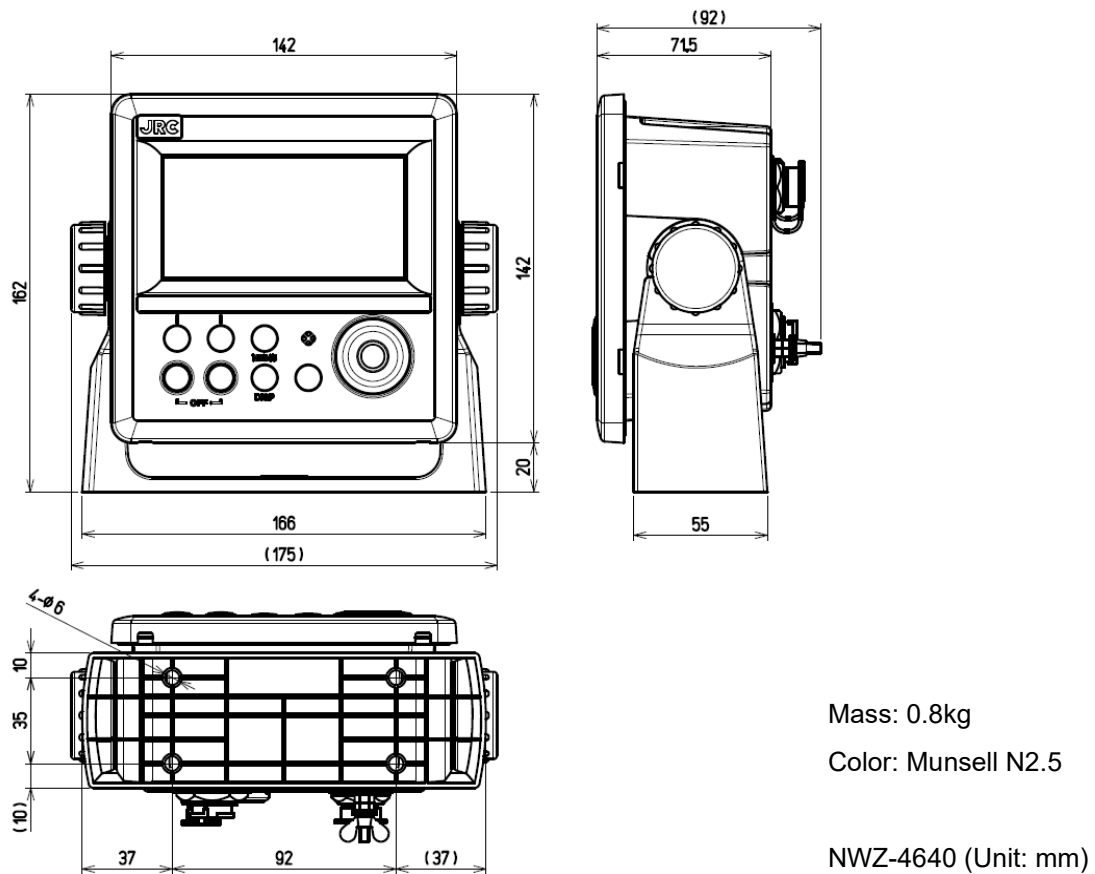

Distribution processor NQA-7040 for JLN-740A/740N

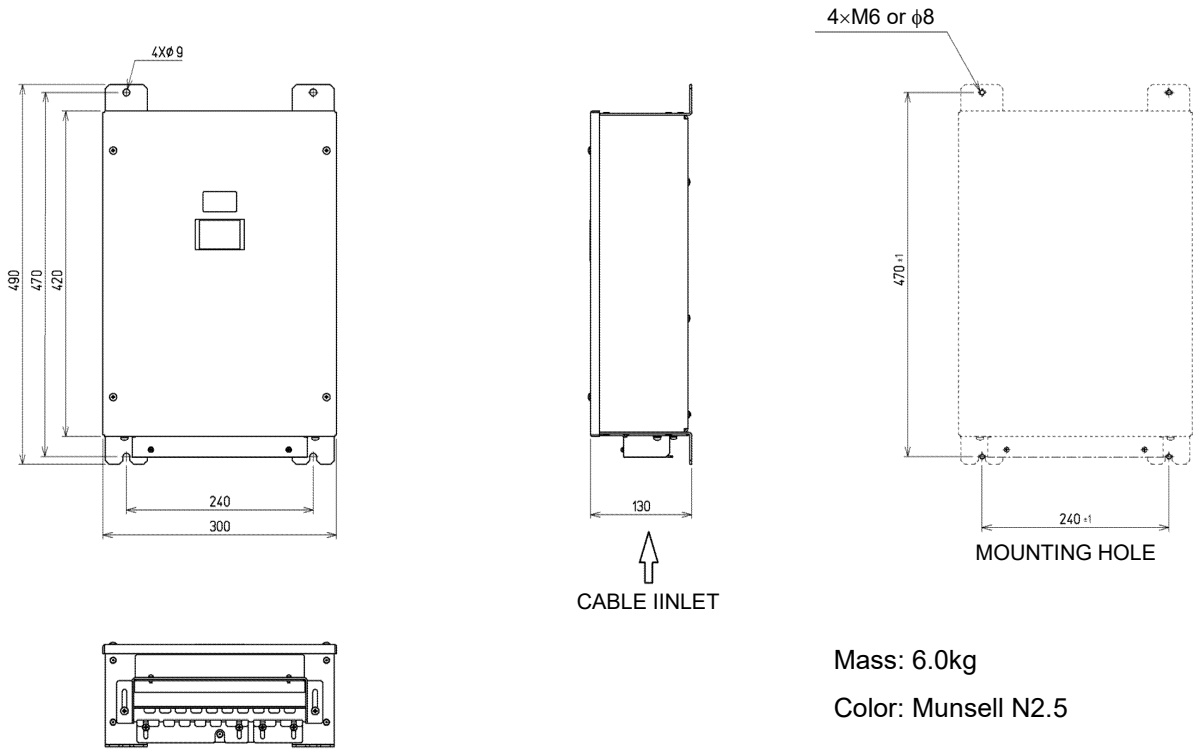

Mass: 6.0kg

Color: Munsell N2.5

NQA-7040 (Unit: mm)

Signal processor NJC-70S

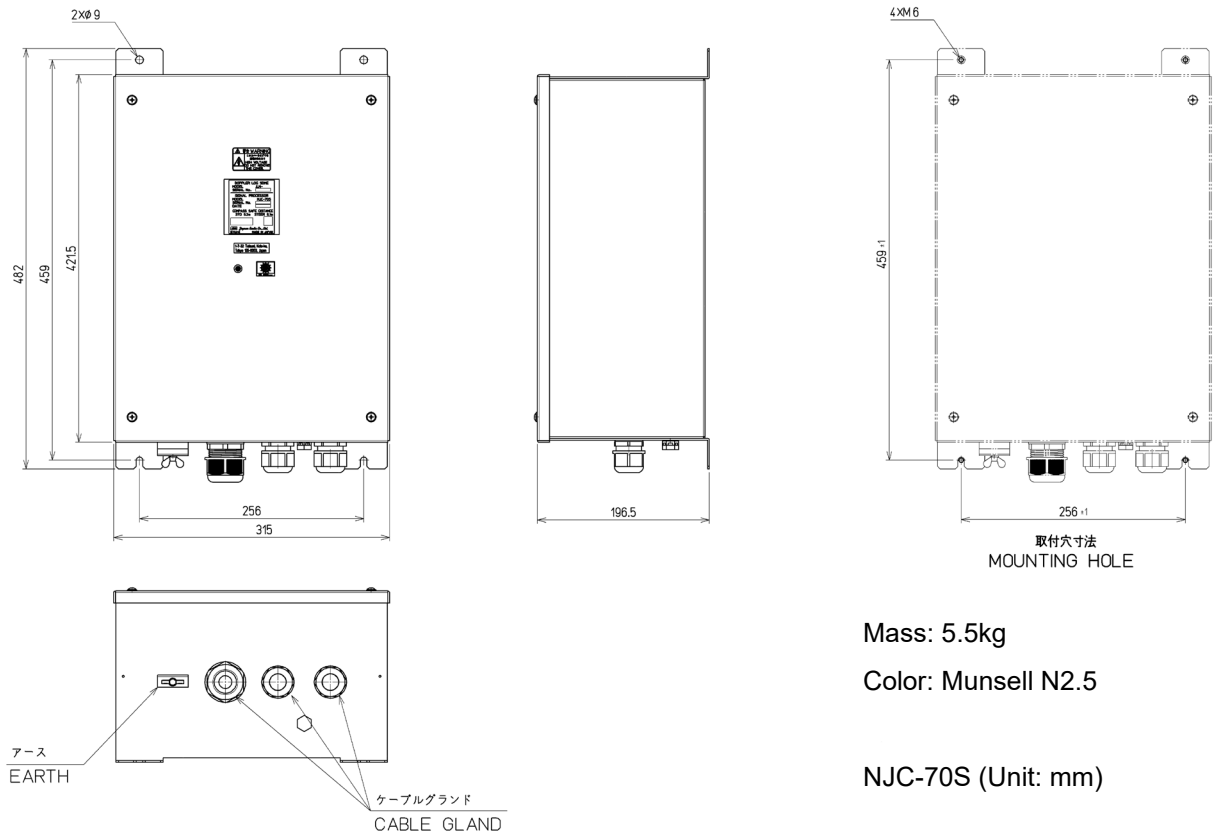

Mass: 5.5kg

Color: Munsell N2.5

NJC-70S (Unit: mm)

Transducer NKF-547

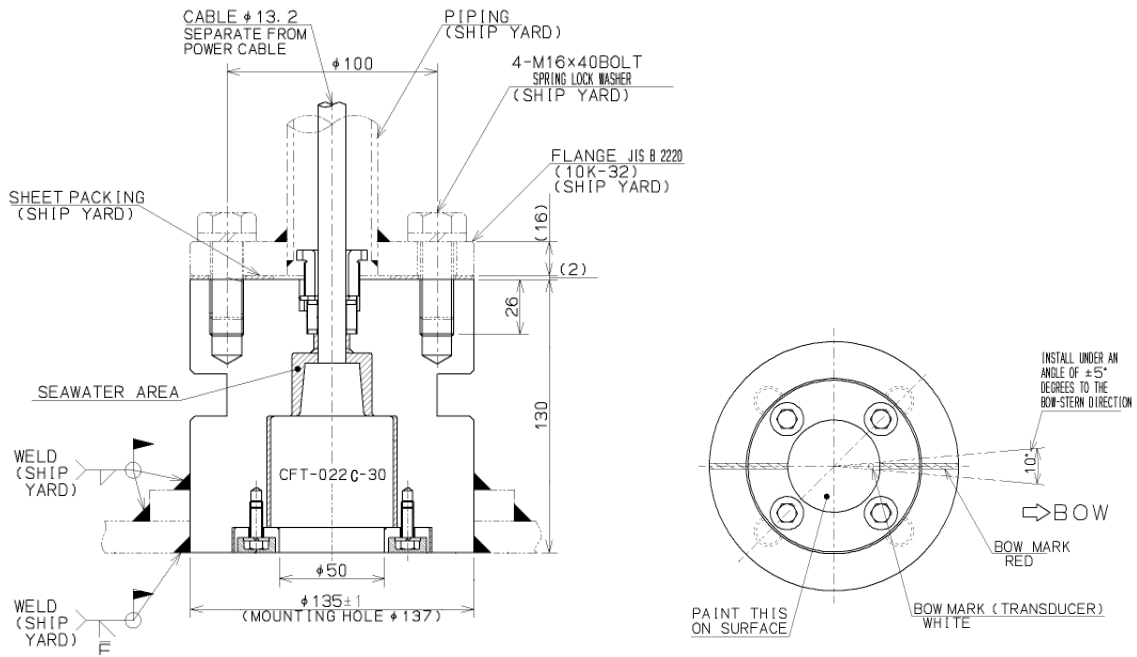

Remote display NWZ-650SDR (optional)

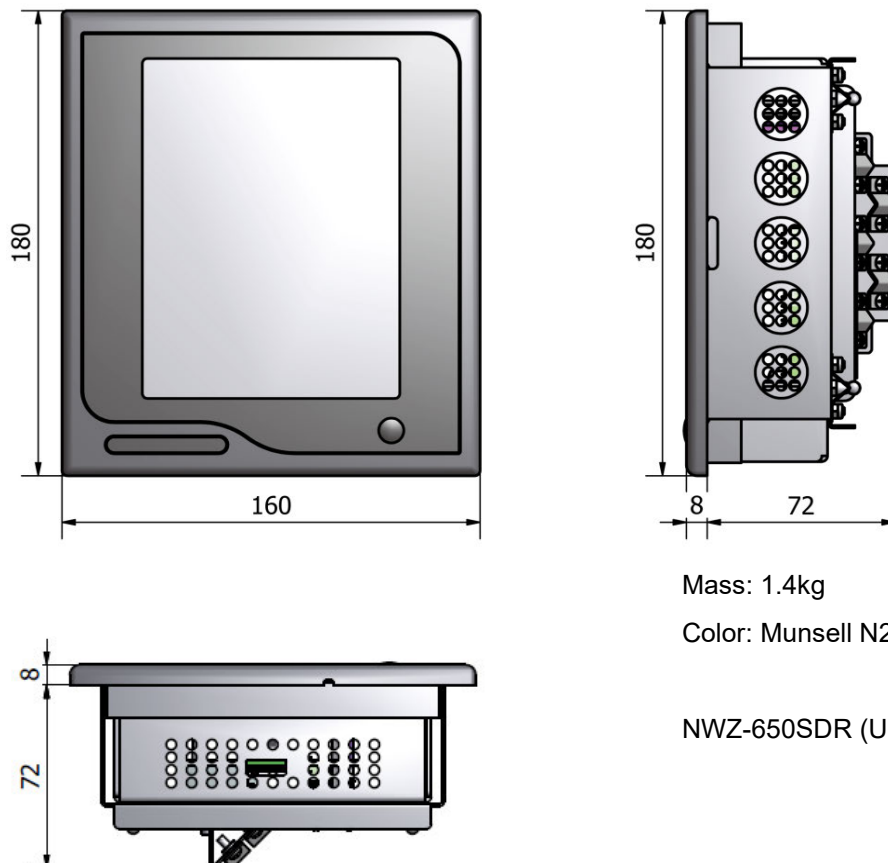

Mass: 1.4kg

Color: Munsell N2.5

NWZ-650SDR (Unit: mm)

Remote display NWZ-840SDR (optional)

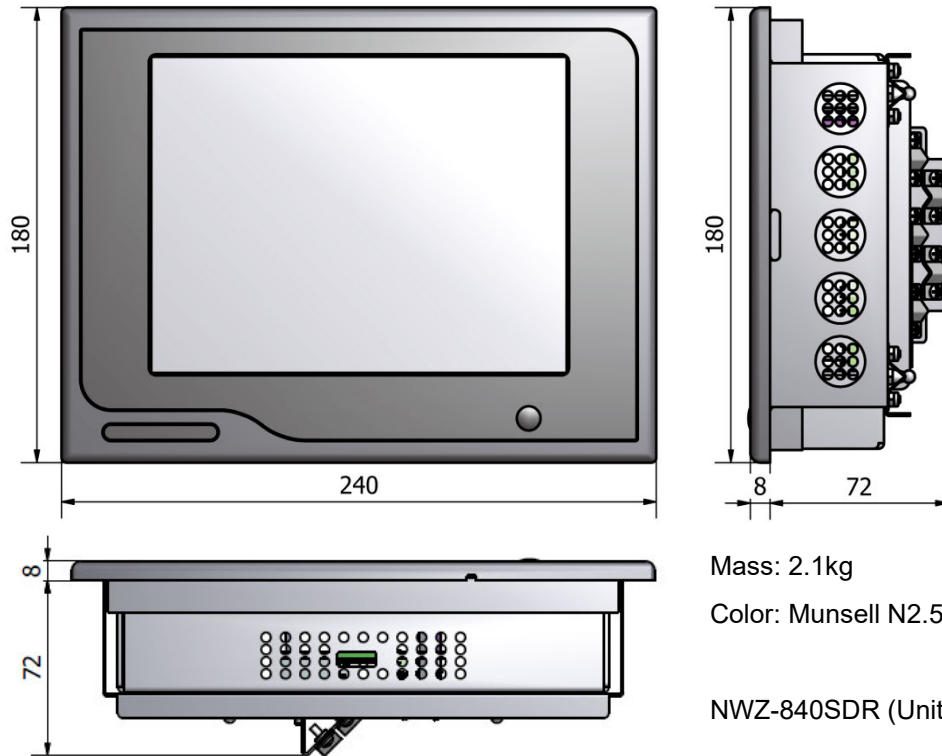

Mass: 2.1kg

Color: Munsell N2.5

NWZ-840SDR (Unit: mm)

Desktop frame MPBX49706 (optional)

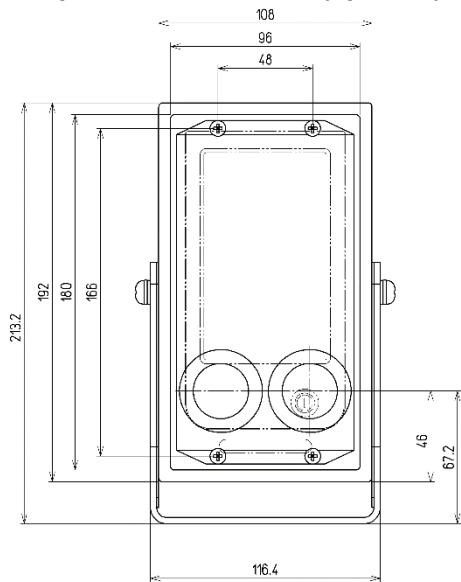

Mass: 1.0kg

Color: Munsell N2.5

MPBX49706 (Unit: mm)

ケーブル導入口
CABLE INLET

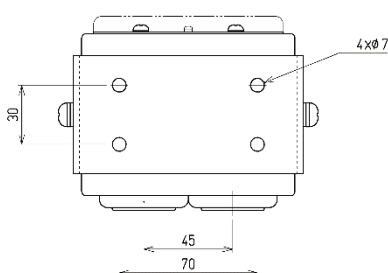

OUTLINE DIMENSIONS		PERMISSIBLE DIMENSIONAL DEVIATIONS
OVER	TO	
3	6	±0.5
6	30	±1
30	120	±1.5
120	400	±2.5
400	1000	±4
1000	2000	±6
2000	4000	±8

外形寸法		寸法許容差
を超え	以下	
3	6	±0.5
6	30	±1
30	120	±1.5
120	400	±2.5
400	1000	±4
1000	2000	±6
2000	4000	±8

Multi Information Display NWZ-4610 (optional)

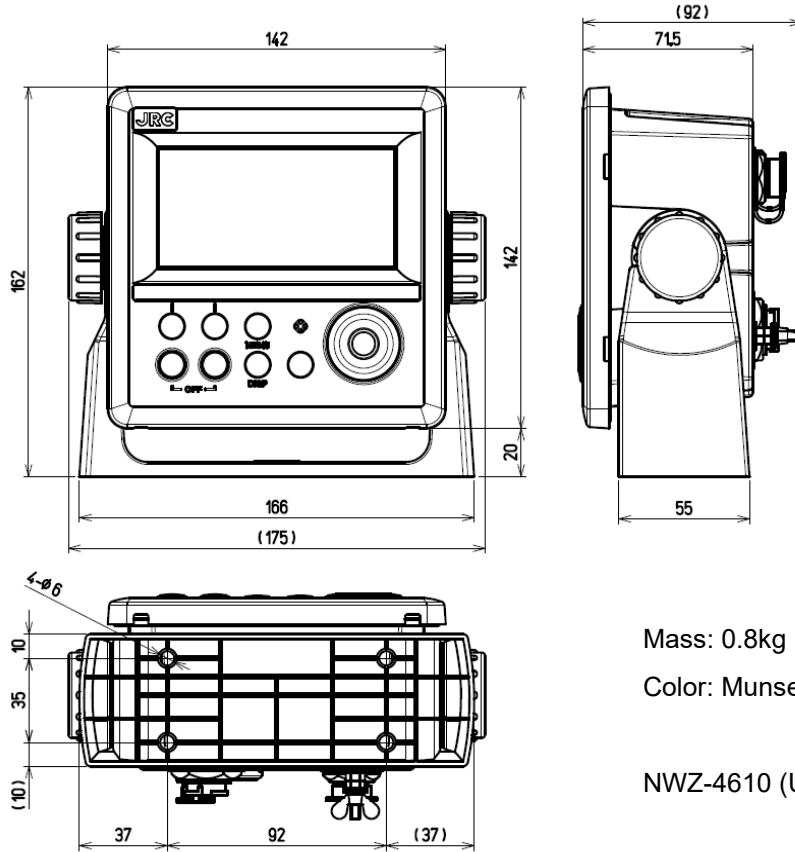

Mass: 0.8kg

Color: Munsell N2.5

NWZ-4610 (Unit: mm)

Distance Counter NWW-7 (Optional)

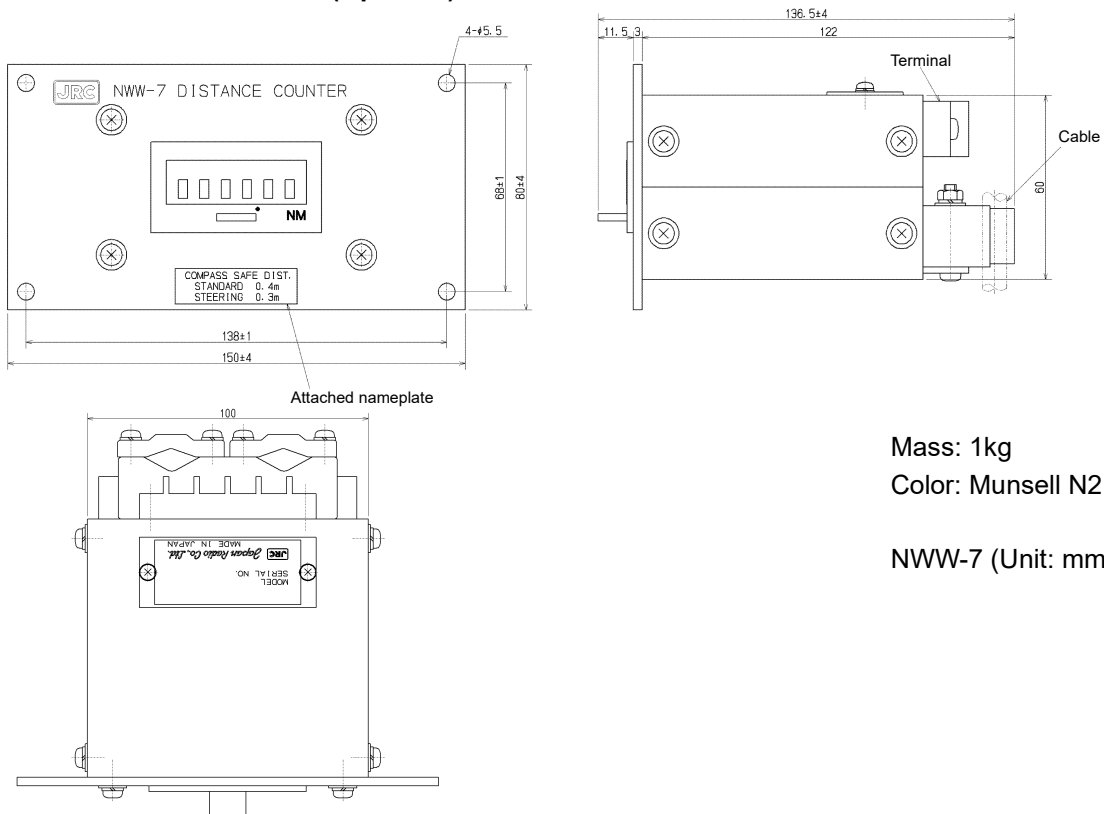

Mass: 1kg

Color: Munsell N2.5

NWW-7 (Unit: mm)

Analog Display NWW-24 (Optional)

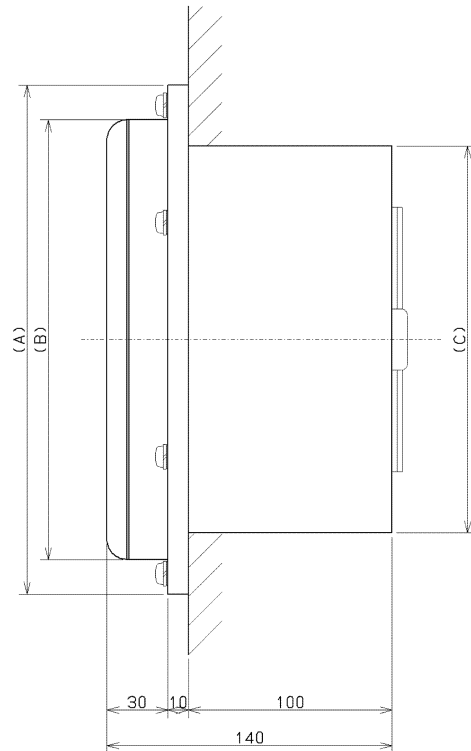
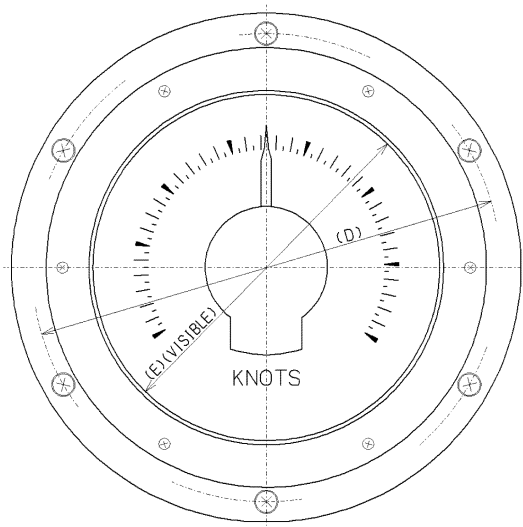

Model	A	B	C	D	E	Mass	Scale panel	E.L panel
NWW-24L	φ250	φ216	φ190	φ230	φ170	6.5 kg	-4 to 20	Green
NWW-24S	φ200	φ173	φ150	φ186	φ125	3 kg	-5 to 25	Orange
							-6 to 30	

NWW-24

(L) (20) (G) Coating colour
 (S) (25) (O) Munsell N2.5
 (30)
 (35)
 (40)

NWW-24 (Unit: mm)

Analog Display NWW-25 (Optional Internal Dimmer)

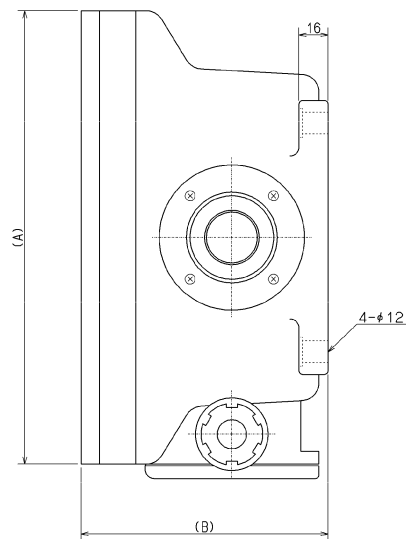
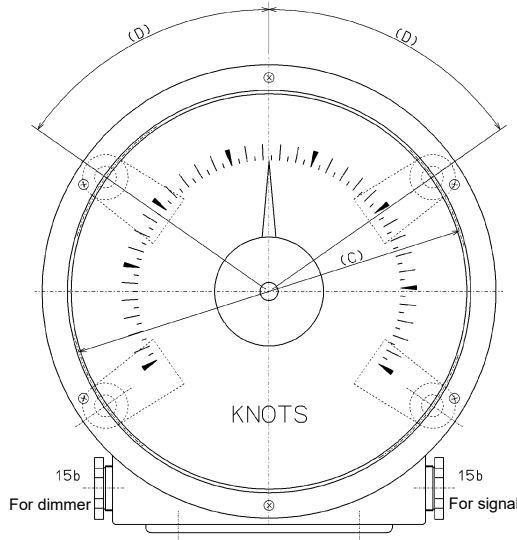

Model	A	B	C	D	Mass	Scale panel	E.L panel
NWW-25L	φ250	136	φ220	55°	7 kg	-4 to 20	Green
NWW-25S	φ200	140	φ180	60°	5 kg	-5 to 25	Orange
						-6 to 30	

NWW-25

(L) (20) (G) Coating colour
 (S) (25) (O) Munsell N2.5
 (30)
 (35)
 (40)

Analog Display NWW-26 (Optional)

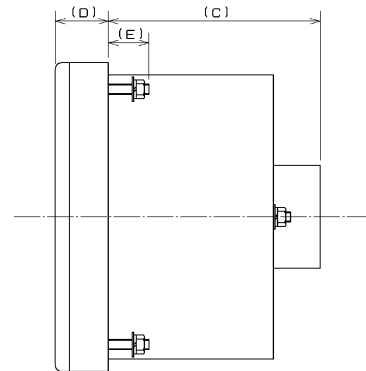
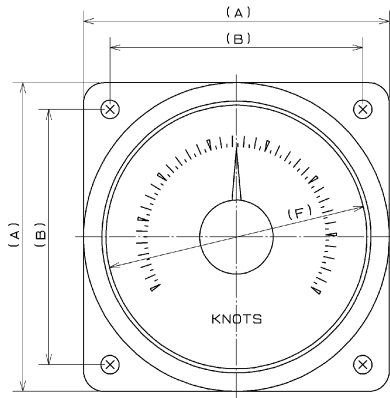

Model	A	B	C	D	E	F	Mass	Scale panel	E.L panel
NWW-26L	150	124	105	26	20	φ 128	2.5 kg	-4 to 20	Green
NWW-26M	120	100	90	23	15	φ 100	1.5 kg	-5 to 25	
NWW-26S	110	90	90	11	15	φ 100	1 kg	-6 to 30	Orange

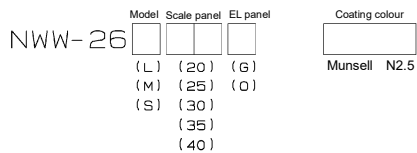
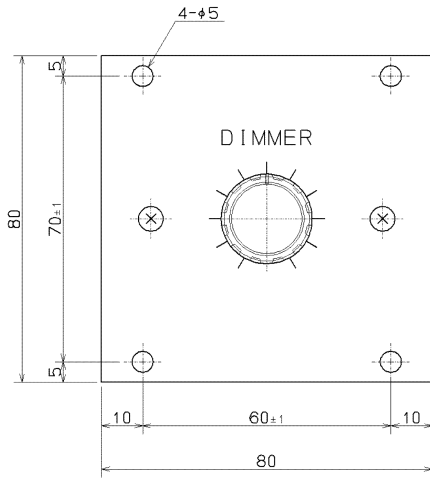
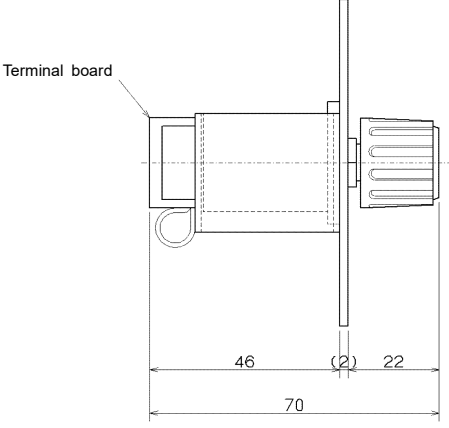

Table 1.1 Analog display size list

Range	Size	NWW-24 (Flush mount type)		NWW-25 (Wall mount type)		NWW-26 (Panel flush mount type)	
		Green EL	Orange EL	Green EL	Orange EL	Green EL	Orange EL
-4~20kn	L	NWW-24L20G	NWW-24L20O	NWW-25L20G	NWW-25L20O	NWW-26L20G	NWW-26L20O
	M	-	-	-	-	NWW-26M20G	NWW-26M20O
	S	NWW-24S20G	NWW-24S20O	NWW-25S20G	NWW-25S20O	NWW-26S20G	NWW-26S20O
-5~25kn	L	NWW-24L25G	NWW-24L25O	NWW-25L25G	NWW-25L25O	NWW-26L25G	NWW-26L25O
	M	-	-	-	-	NWW-26M25G	NWW-26M25O
	S	NWW-24S25G	NWW-24S25O	NWW-25S25G	NWW-25S25O	NWW-26S25G	NWW-26S25O
-6~30kn	L	NWW-24L30G	NWW-24L30O	NWW-25L30G	NWW-25L30O	NWW-26L30G	NWW-26L30O
	M	-	-	-	-	NWW-26M30G	NWW-26M30O
	S	NWW-24S30G	NWW-24S30O	NWW-25S30G	NWW-25S30O	NWW-26S30G	NWW-26S30O

Dimmer Unit NCM-227 (Optional)



Mass: 0.5kg
Color: Munsell N2.5

NCM-227 (Unit: mm)

Dimmer Unit NCM-329 (Optional)

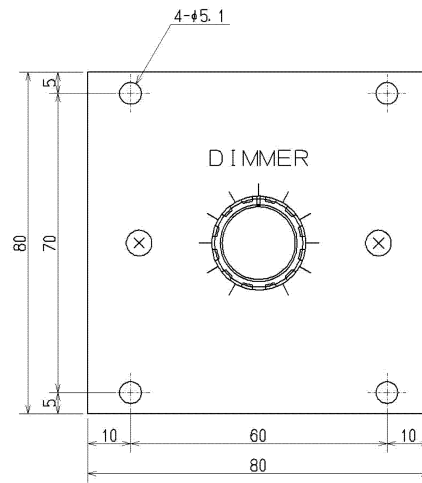
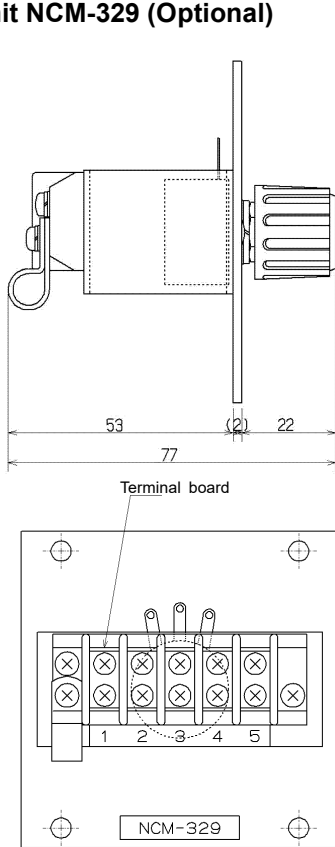

Mass: 0.5kg
Color: Munsell N2.5

NCM-329 (Unit: mm)

Junction Box CQD-10 (Optional)

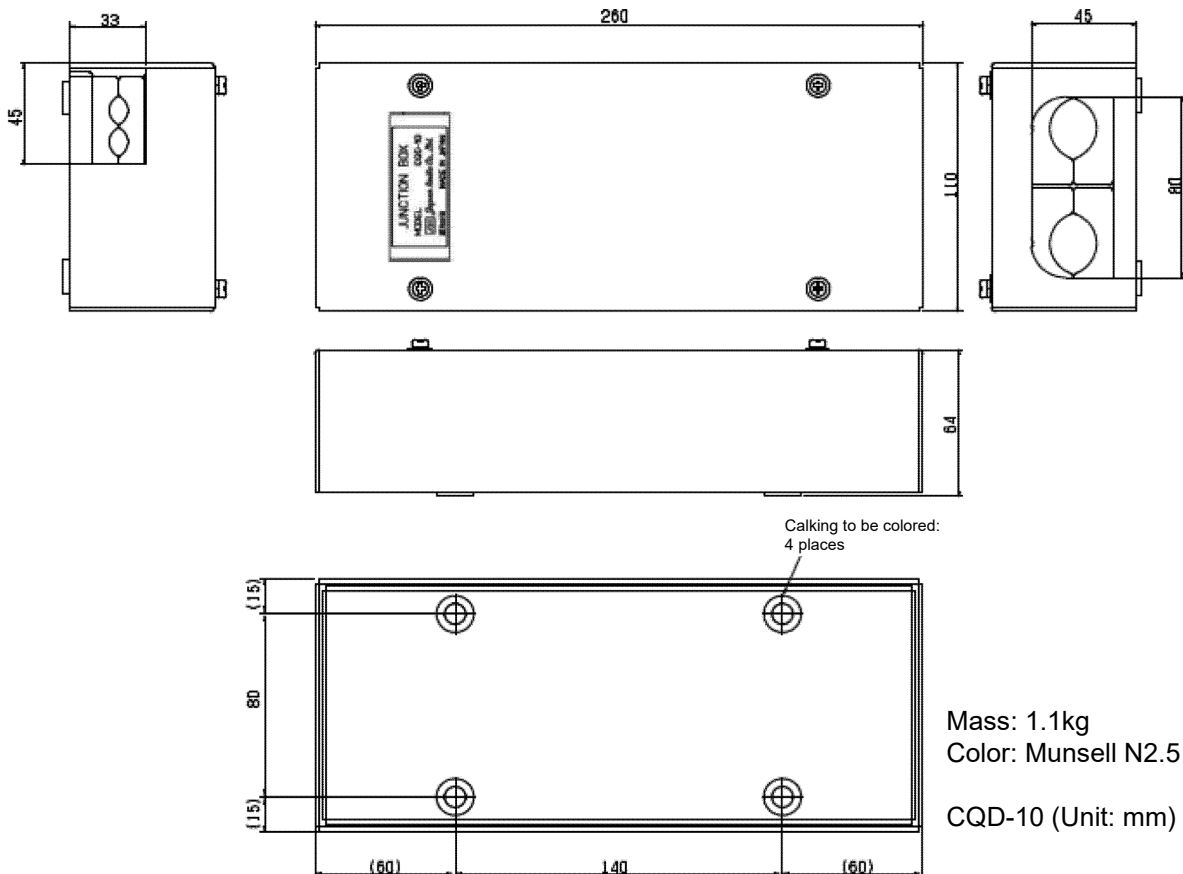

Mass: 1.1kg
Color: Munsell N2.5

CQD-10 (Unit: mm)

Transducer Mounting NKF-531E (Optional)

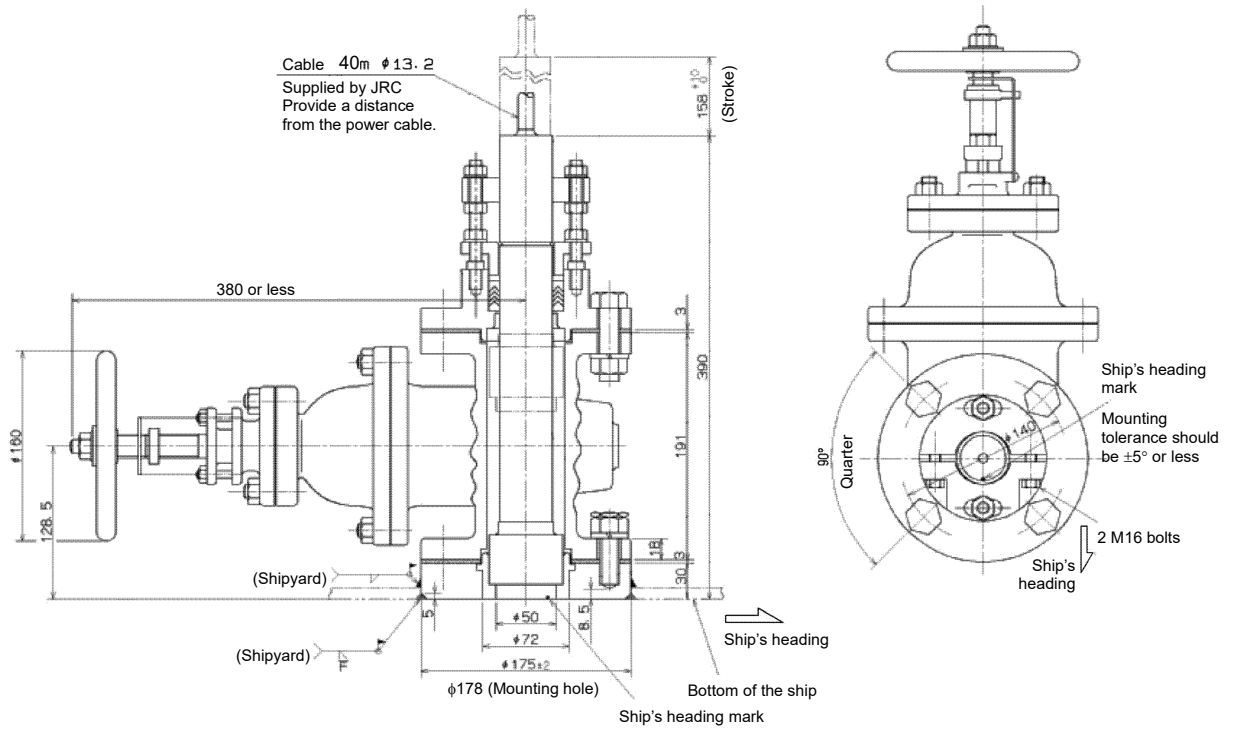

Mass: 48kg

NKF-531E (Unit: mm)

Table 1.2 Control according to dimmer unit NCM-227 / NCM-329

Item name	Model	Central dimmer (DDC)	NCM-227 dimmer unit	NCM-329 dimmer unit
Main Display	NWZ-510SDW	○(Linking)	○(Linking)	×
	NWZ-4640	○(Linking)	○(Linking)	×
Remote Display	NWZ-650SDR	○(Linking)	○(Linking)	×
	NWZ-840SDR	○(Linking)	○(Linking)	×
MID	NWZ-4610	○(Direct connect)	○(Direct connect)	×
Analog Display	NWW-24	×	×	○(Direct connect)
	NWW-25	×(Internal)	×(Internal)	×(Internal)
	NWW-26	×	×	○(Direct connect)
Distance Counter (Distance counter NWW-7 there is no lighting.)	NWW-7	×	×	×

1.5 System Configuration

1.5.1 JLN-740A System Configuration Diagram

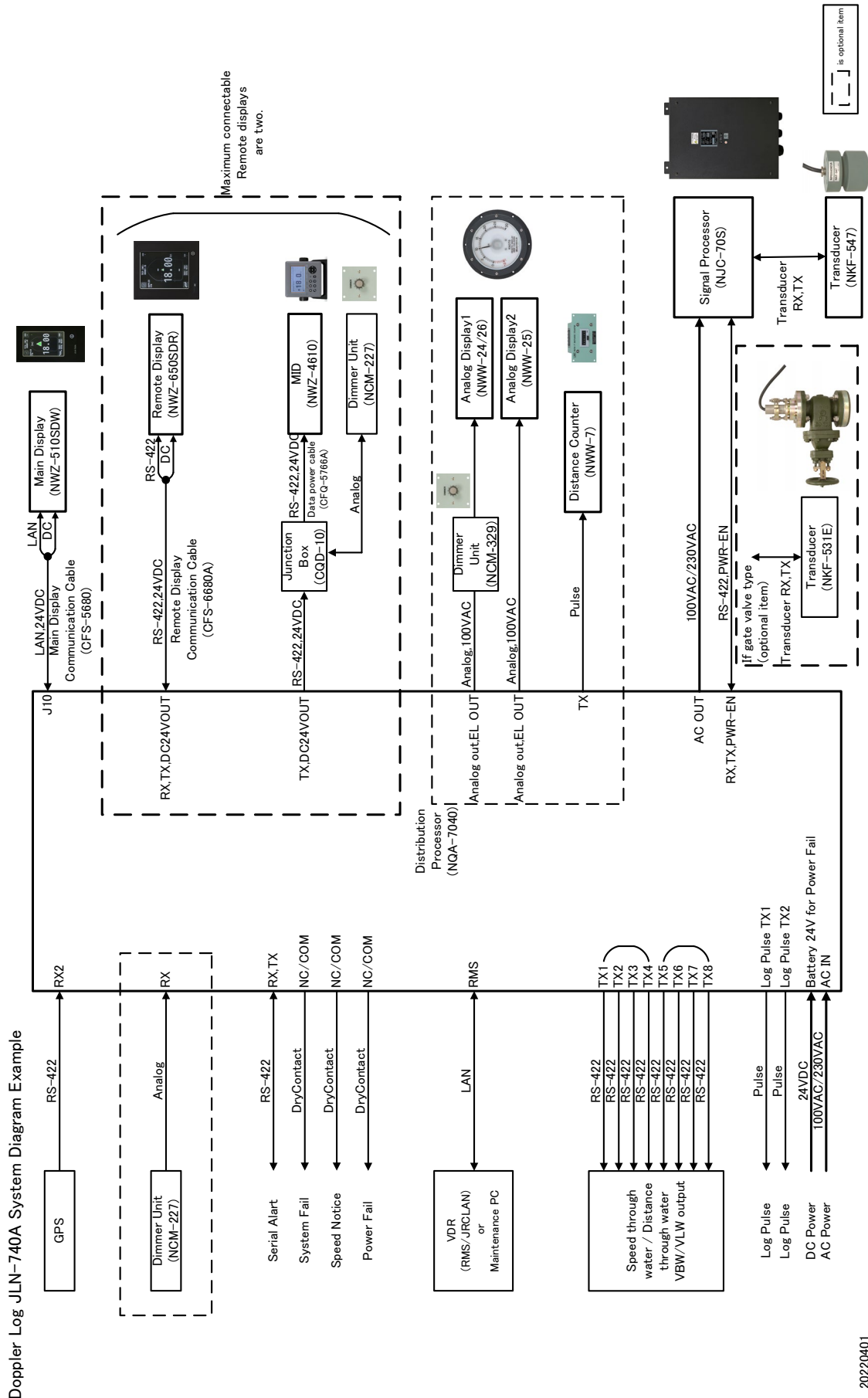

1.5.2 JLN-740N System Configuration Diagram

Doppler Log JLN-740N System Diagram Example

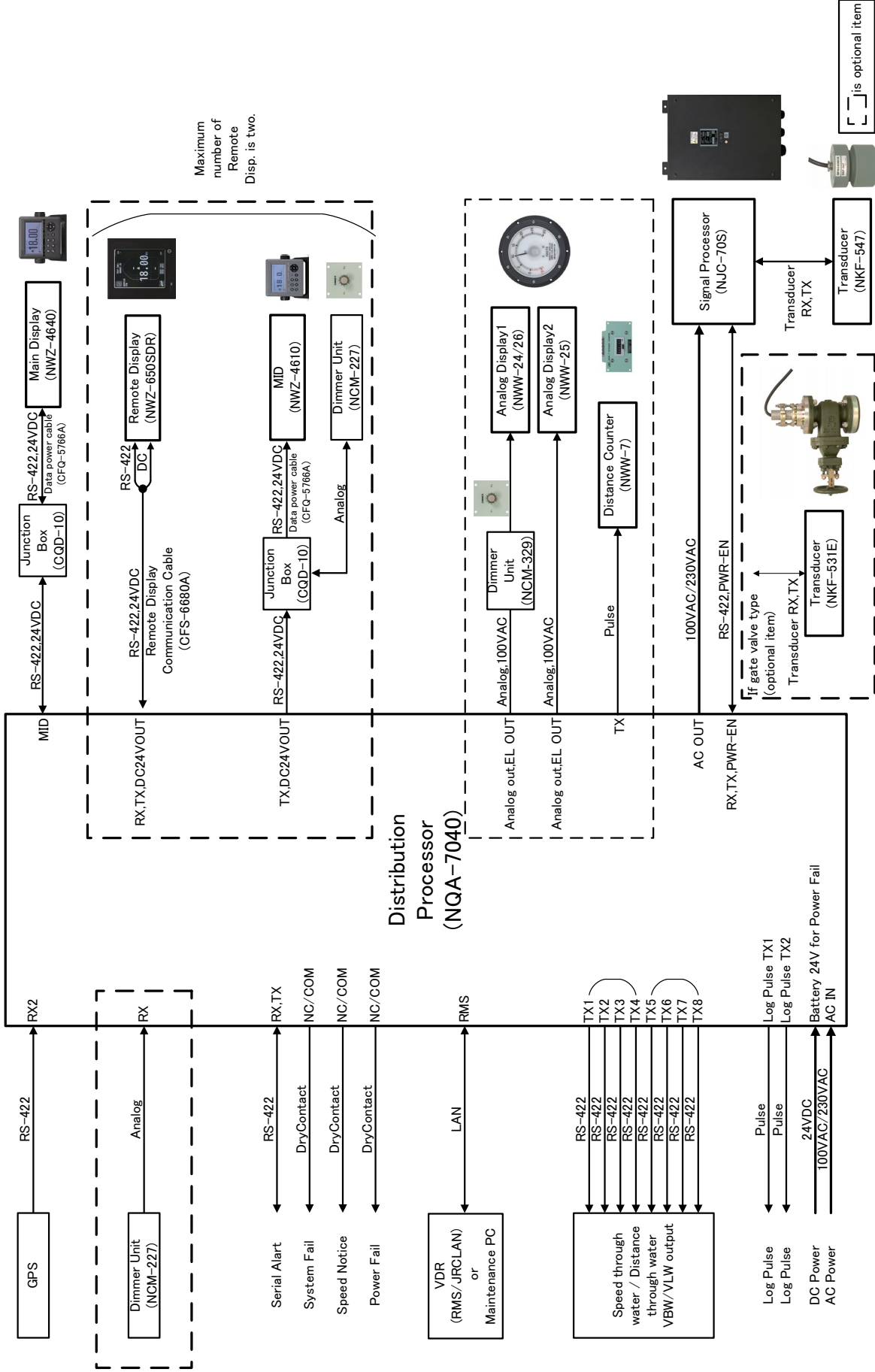

1.5.3 JLN-741A System Configuration Diagram

Doppler Log JLN-741A System Diagram Example

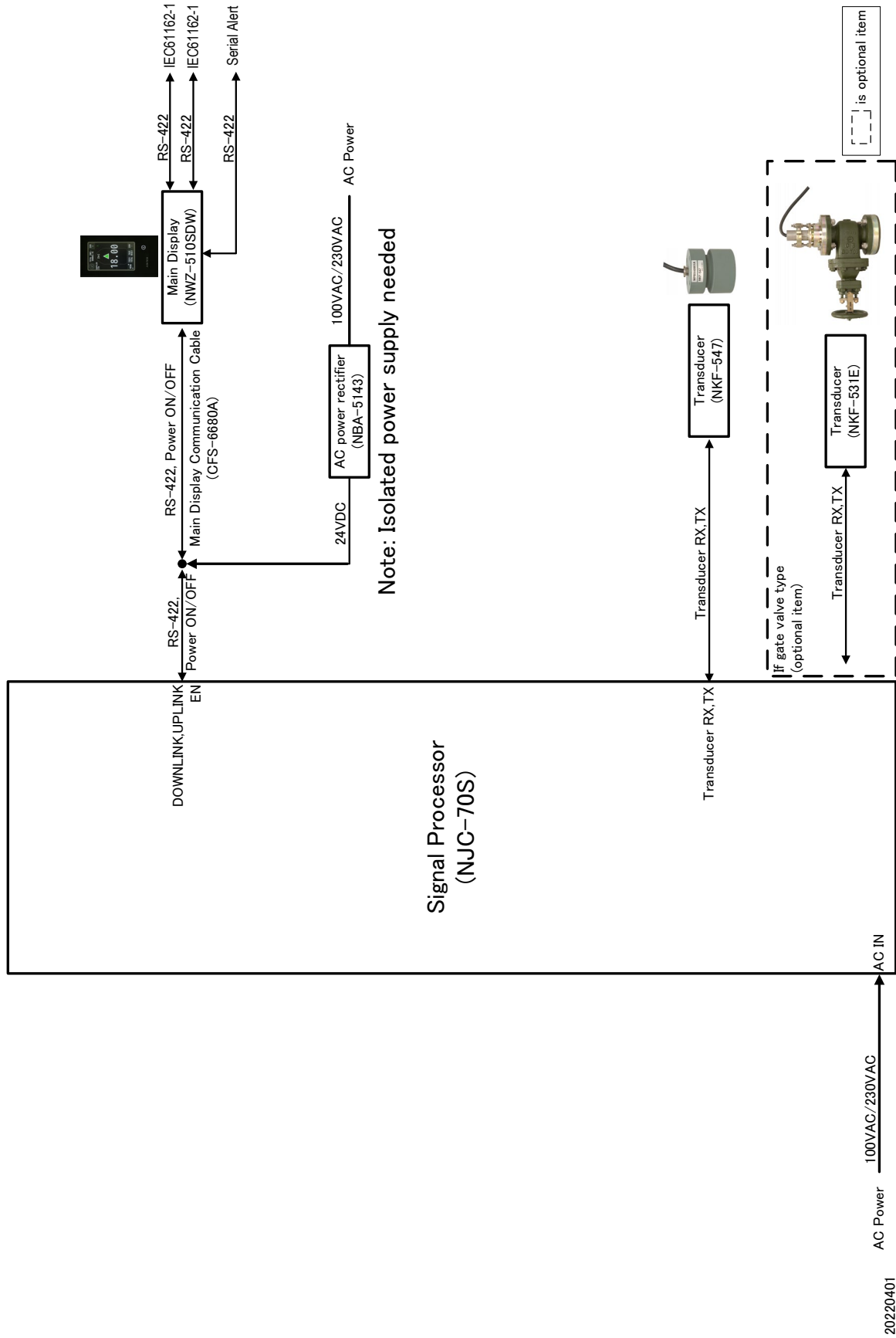

1.5.4 JLN-741N System Configuration Diagram

Doppler Log JLN-741N System Diagram Example

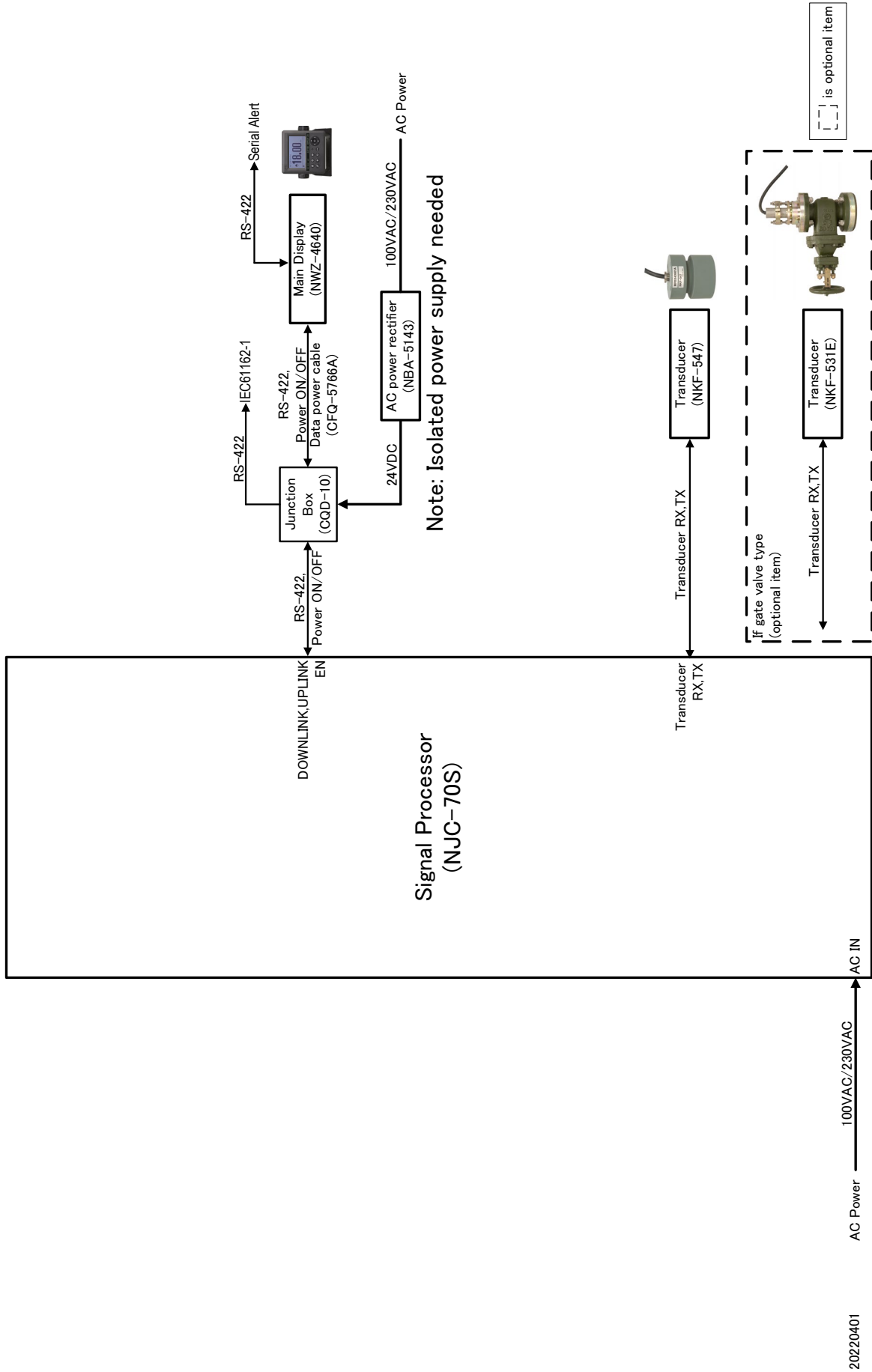

(This page intentionally left blank)

Chapter 2 Function of Each Component

2.1 Main Display NWZ-510SDW (For JLN-740A/741A)

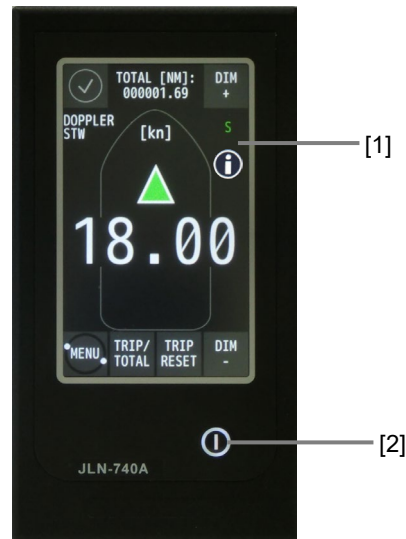











No.	Name	Function
[1]	Display	<ul style="list-style-type: none"> • Displays the following information as a display. <ul style="list-style-type: none"> - Operation status of the equipment (normal/abnormal) - Fore/after speed - Trip distance /total distance - Maintenance information when ⓘ is displayed. • The following operations are enabled on the display. <ul style="list-style-type: none"> - Brightness adjustment - Switching between trip distance display and total distance display - Resetting a trip distance - Calling a menu
[2]	Power supply button	Turns power supply ON/OFF whenever the button is pressed.

For more detailed information, please refer to Chapter 3.

2.2 Main Display NWZ-4640 (For JLN-740N/741N)



No.	Name	Function
[1]	 Power/Contrast	Use this key to turn on the power. Adjust the contrast. To turn off the power, press this key together with the 
[2]	 Dimmer	Use this key to adjust the brightness of the back light.
[3]	 Menu	Use this key to display the Alert list and main menu. Short push to display the active alert list. Two second push to display the main menu.
[4]	 Display	Use this key to switch the display screens.
[5]	 Clear	Use this key to cancel the operation. Use this key also to close the alert window.
[6]	 Enter	Uses this key to determine the operation.
[7]	 Trip reset	When this button is pressed for one second or longer, the distance (trip distance) is reset.
[8]	 Unit	Use this key to change the unit.
[9]	 Cursor	Use this key to move the cursor.

2.3 Remote Display (Optional) NWZ-650SDR/840SDR

Remote display NWZ-650SDR (optional)

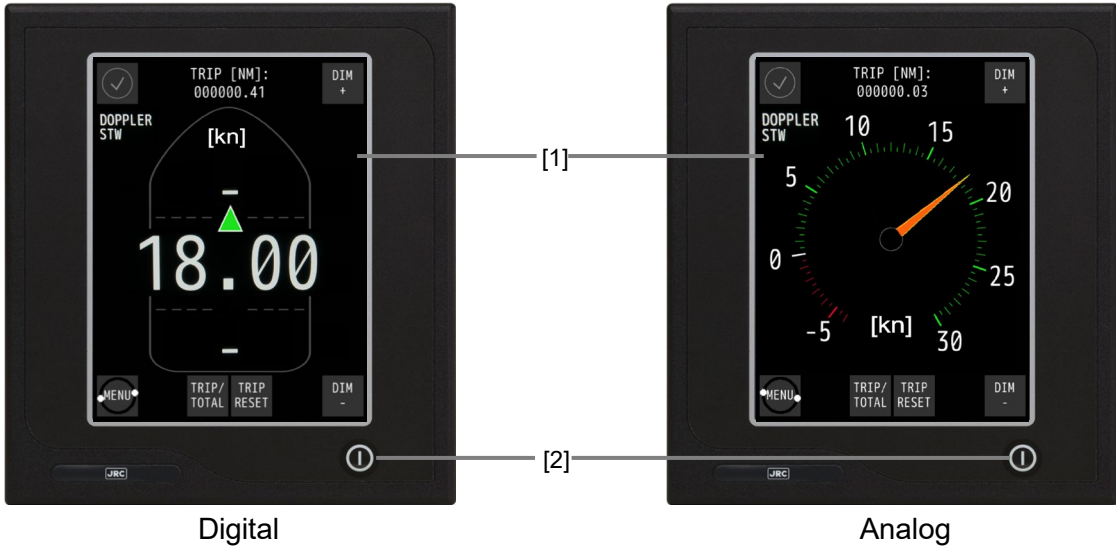

Remote display NWZ-840SDR (optional)

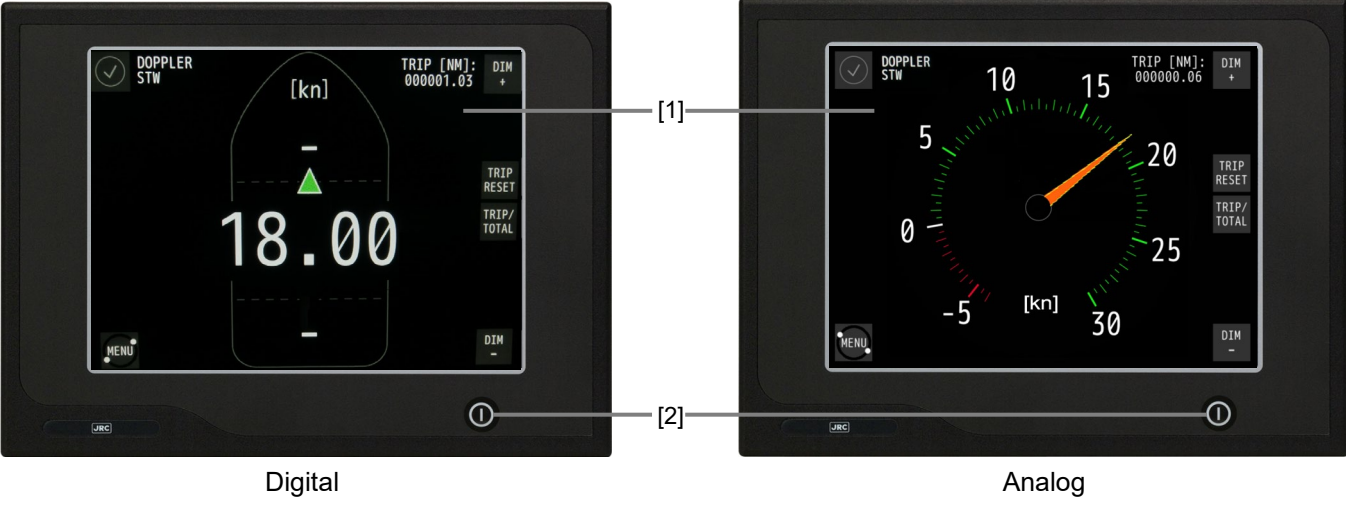







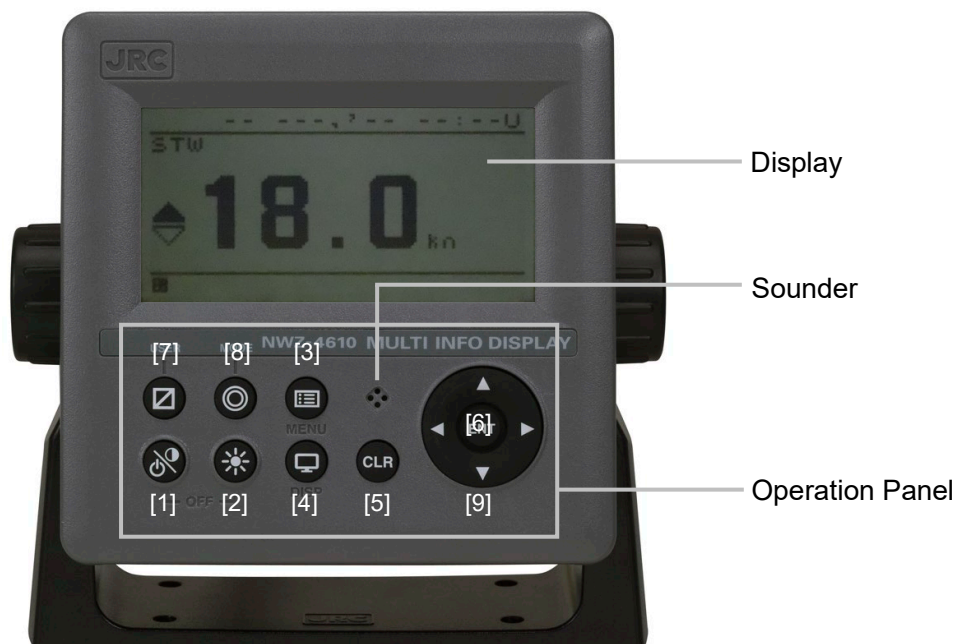



No.	Name	Function
[1]	Display	<ul style="list-style-type: none"> • Displays the following information as a display. <ul style="list-style-type: none"> - Operation status of the equipment (normal/abnormal) - Fore/after speed (in digital or analog) - Trip distance/total distance • The following operations are enabled on the display. <ul style="list-style-type: none"> - Brightness adjustment - Switching between trip distance display and total distance display - Resetting a trip distance - Calling a menu
[2]	Power supply button	Turns power supply ON/OFF whenever the button is pressed.

For more detailed information, please refer to Chapter 3.

2.4 MID (Optional) NWZ-4610



No.	Name	Function
[1]	 Power/Contrast	Use this key to turn on the power. Adjust the contrast. To turn off the power, press this key together with the 
[2]	 Dimmer	Use this key to adjust the brightness of the back light.
[3]	 Menu	Use this key to display the main menu.
[4]	 Display	Use this key to switch the display screens.
[5]	 Clear	Use this key to cancel the operation. Use this key also to stop the alert.
[6]	 Enter	Uses this key to determine the operation.
[7]	 USER	Uses this key to changes the screen to the user registration screen.
[8]	 MODE	Uses this key to change the user mode.
[9]	 Cursor	Use this key to move the cursor.

2.5 Distance Counter (Optional) NWW-7



No.	Name	Function
[1]	Trip reset	Press this key to reset TRIP.

(This page intentionally left blank)

Chapter 3 Operation Method (JLN-740A/741A)

WARNING



The Doppler log must be used strictly as navigation aid equipment only. The final decision on navigation must be made by the pilot. If the final decision is made based on the information displayed by the Doppler log only, an accident such as collision or grounding may occur.



This equipment must not be used by anyone except the ship's crews and specialized maintenance staff. Failure to comply may result in misuse.

CAUTION



Do not carry out operation of touch panel by a sharp object. Otherwise, the screen may be damaged.



If power outage occurs inside of the ship during the operation of the Doppler log, the image may be disturbed or may not be displayed. In this case, reconnect the power supply.



When the power supply is turned off on the display unit, the equipment then starts when the on-board power supply is turned off/on. This is normal.



If your ship is not on the water such as when it is docked, do not start transmission. Otherwise, the transducer will be damaged.

3.1 Basic Operation

3.1.1 Power Supply ON/OFF



- 1 When the main power supply on the power board is turned on, the display unit power supply is turned on automatically.**

When the power supply is turned off by the key operation on the display unit, the power supply can be turned on by long pressing the power supply button for one second or longer. The power supply is turned on and the start screen is displayed.



After about one minute, the START TRANSMIT screen is displayed.



When the [START TRANSMIT] button is touched, the normal screen is displayed. Transmission starts.

When the power supply button is pressed again for one second or longer, the shutdown screen is displayed the same as the start screen and the power supply is turned off after about 30 seconds and the screen disappears.

⚠ CAUTION Do not shut down the system until the START TRANSMIT screen is displayed.

⚠ CAUTION When the power supply is turned off on the display unit, the equipment then starts when the on-board power supply is turned off/on. This is normal.

⚠ CAUTION After the blackout test, the system would start up and the START TRANSMIT screen would be displayed.

3.1.2 Adjusting Brightness

Adjust the brightness to the suitable level for display.
Adjust the brightness by touching the [DIM+] button/[DIM-] button on the display.
The brightness is set to maximum initially.

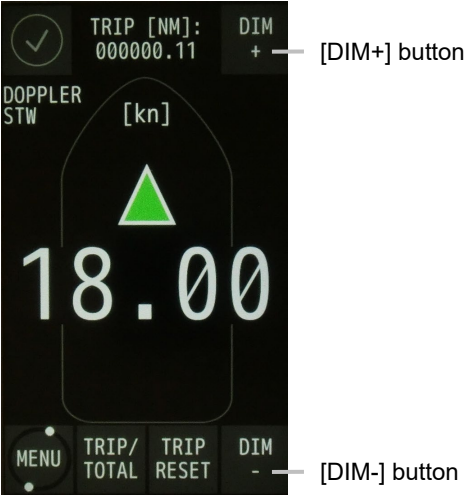

Main Display NWZ-510SDW

When the [DIM+] button is touched, the display brightness increases and the display can be dimmed by touching the [DIM-] button.
17 brightness levels are available.

CAUTION Under the minimum brightness, the ship speed display and accumulated sailing distance/trip distance display disappear. Only each corner icons: [ALERT], [DIM+], [DIM-], [MENU] would display.

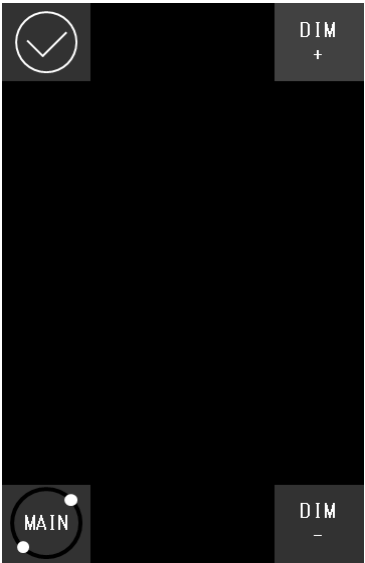

3.2 Displaying Ship Speed/Accumulated Sailing Distance

On the normal screen, fore/after speed and accumulated sailing distance are displayed.

3.2.1 Displaying Ship Speeds

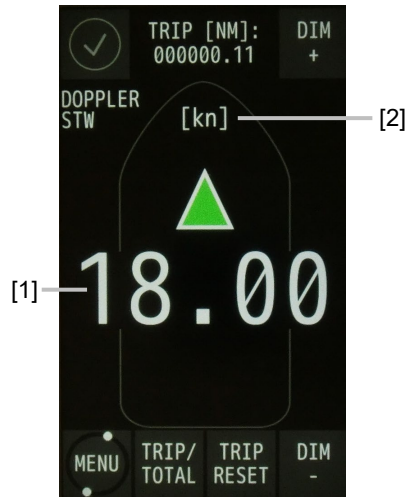

Main Display NWZ-510SDW

No.	Display	Remarks
[1]	Fore/after speed	When the ship is moving in the ahead direction, ▲ is displayed and when the ship is moving in the astern direction, ▼ is displayed.
[2]	Ship speed unit	The unit of ship speed can be set to kn or m/s by operating the menu. For setting the ship speed unit of the main display, refer to "4.1.3.7 Ship Speed Unit Settings".

3.2.2 Displaying the Accumulated Sailing Distance

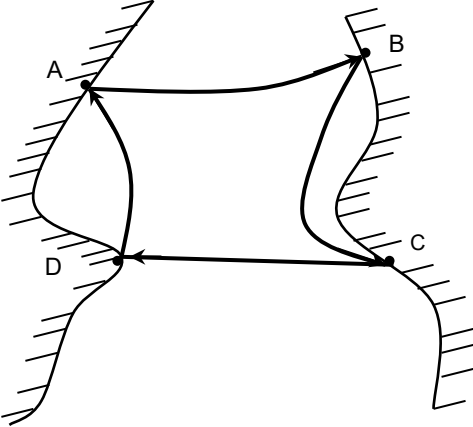

Main Display NWZ-510SDW

No.	Display/button	Remarks
[1]	Sailing distance (accumulated sailing distance or trip distance)	<p>Whenever the [TRIP/TOTAL] button is touched, the display is switched between the accumulated sailing distance and the trip distance.</p> <p>As shown below, when a ship leaves point A, stopover at points B, C, and D, then goes back to point A, the [TRIP] (trip distance) is used to calculate the distance of each of the individual segments between the point.</p> <p>For [TOTAL] (accumulated sailing distance), it is used for calculation of the total distance.</p> 
[2]	[TRIP/TOTAL] button	Whenever the button is touched, the display is switched between the accumulated sailing distance and the trip distance.
[3]	[TRIP RESET] button	<p>When this button is touched, a confirmation window is displayed.</p> <p>When the [✓] button is touched, the trip distance display is reset to 0.</p> <p>When the [×] button is touched, the normal screen is displayed.</p>

CAUTION

Resetting of the accumulated sailing distance is unable to general users.

For resetting the accumulated sailing distance, please request to the store, nearest JRC agent, JRC marine service department, sales department, regional office, branch or sales office.

3.3 Displaying Alert

The Normal icon is displayed while this equipment is functioning normally.

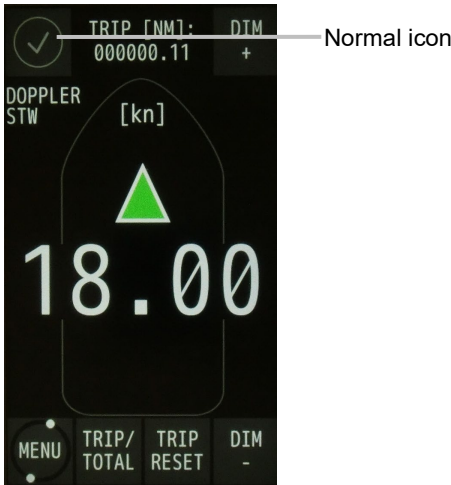

Main Display NWZ-510SDW

When an alert occurs, the event is notified with alert icon.
 Every pressing the alert icon, alert content will appear and disappear.

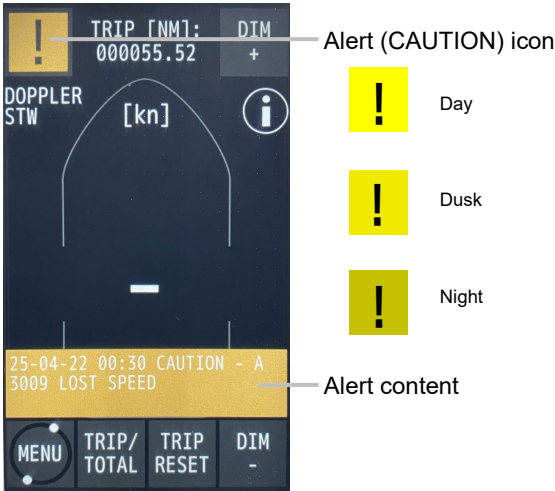

When speed through the water cannot be measured, --.-- kn is displayed for the ship speed value.

Display of the alert icon remains unless the alert is rectified.

To re-confirm the history of the alerts that occurred (history of the occurrence and rectification), refer to "4.1.3.11 Alert history".

The Alert Icons are as follows.



- Alert color
- Caution color is yellow.

The alert types displayed are as follows.

JLN-740A / JLN-741A Alert List

Pop up message	Criteria	ID	Priority	Possible Causes / Guidance
LOST SPEED	IEC 62923-2 Table A.1	3009	Caution	No signal processor data received. The signal processor has failed. Alert will be rectified by normal received from signal processor.

3.3.1 General state transition of the Alerts

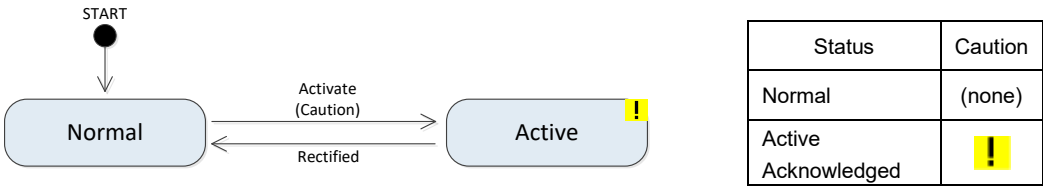

(This page intentionally left blank)

Chapter 4 Setting by Using Menus (JLN-740A/741A)

In JLN-740A/741A, various settings and adjustments can be performed by using the menus that are displayed.

CAUTION



Adjustments must be made by specialized service technicians.
Incorrect settings may result in unstable operation, and this may lead to accidents or equipment failure.



Adjust the brightness of main display according to the surrounding lighting.
In NWZ-510SDW, the setting of [NIGHT] may interfere with the recognition of display information.
In NWZ-4640, the setting of [MINIMUM] may interfere with the recognition of display information.

4.1. Setting of NWZ-510SDW

4.1.1. Main Menu

Touch the [MENU] button on the normal screen.

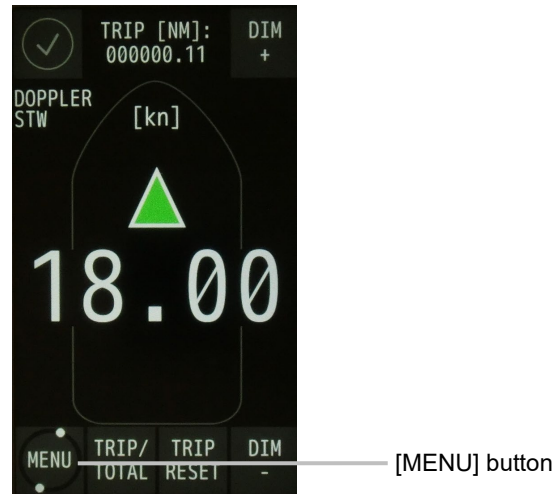

Main Display NWZ-510SDW

The main menu is displayed.



JLN-740A

JLN-741A

Main Display NWZ-510SDW

The function of each menu is listed below.

Menu	Function
[TOUCH CAL] (Touch position calibration)	Calibrate the display positions.
[THEME] (Brightness adjustment)	Set the brightness of the display to DAY, DUSK, or NIGHT.
[MAINT INFO] (Maintenance Information)	Displayed the maintenance information
[DATE TIME] (System clock adjustment)	Set up the system clock; YEAR/ MONTH/ DAY/ HOUR/ MINUTE.
[ABOUT](Information on this equipment)	Displays the information relating to this equipment such as the software version.
[ADV SET] (Advanced setting)	Menu for relevant engineers only. This function is not used by general users.
[DIGITS] (Number of speed indication digits)	Selecting the number of digits for ship speed indication.
[UNITS] (Unit setting)	Select the unit of the ship speed that is displayed on the normal screen.
[SDME] (SDME Setting)	Set an upper limit and a lower limit for the ship speed and issue an notice when the ship speed exceeded the set range. Set an bubble detection level.
[ADV SDME] (Advanced setting of this equipment)	Menu for relevant engineers only This function is not used by general users.
[ALERT LIST] (Alert list)	Displays the list of current alerts.
[ALERT HIST] (Alert history) (JLN-740A only)	Displays the history of all alerts that occurred. * JLN-741A does not have the ALERT HIST function.

4.1.2. Common Operation of Each Menu

The following buttons perform the common functions.

(Left: An example of the screen that is displayed by operating the [DATE/TIME] menu is used for the explanation.)

(Center: An example of the screen that is displayed by operating the [SPEED LIMIT] menu is used for the explanation.)

(Right: An example of the numeric input screen that is displayed by operating the [SPEED LIMIT] menu numeric input box is used for the explanation.)

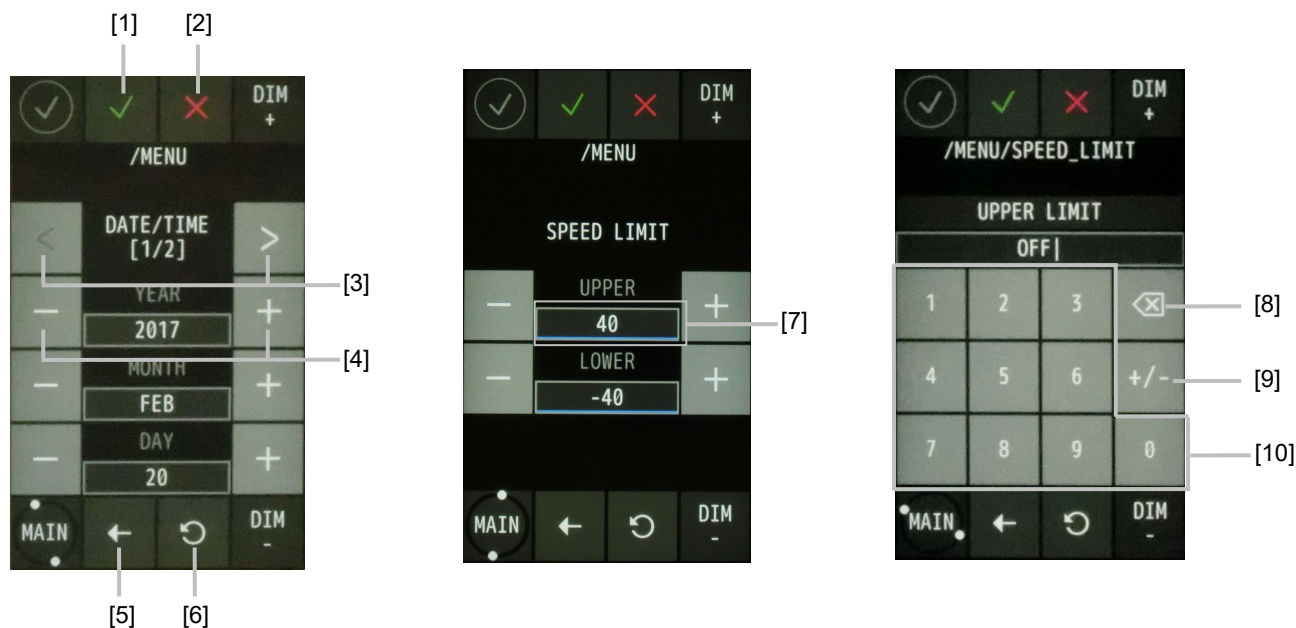

No.	Name	Function
[1]	(Enter) button	Saves the setting/changed contents and returns to the previous page. Saved setting is kept even after the power supply of this equipment is turned off.
[2]	(Reset and close) button	Resets all the settings/modifications and returns to the previous screen.
[3]	[<]/[>] (Change page) button	Turns the pages when the menu comprises multiple screens (pages).
[4]	[-]/[+] (Minus and plus) button	Increases/decreases the value and enables selection of another value.
[5]	(Return) button	Resets the current setting and returns to the previous screen.
[6]	(Undo) button	Resets the last setting/modification.
[7]	Numeric input box	When you touch the numeric input box with blue underline, it switches to the numeric input screen and you can enter the numerical value.
[8]	(Delete) button	Delete the entered numeric value or character.
[9]	[+/-] (Minus and plus) button	Enter positive (plus) and negative (minus) as the entered numerical value.
[10]	[0] to [9] (numeric) button	Enter numbers from 0 to 9 respectively.

4.1.3. Operation of Each Menu

4.1.3.1. Touch Position Calibration

When the touched position and the intended button do not match when the screen is touched, adjust the touched position in this menu.

1 Touch the [TOUCH CAL] button in the main menu.

A touch position calibration confirmation screen is displayed.

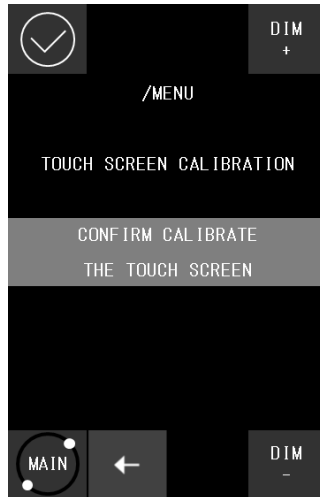

2 Touch [CONFIRM CALIBRATE THE TOUCH SCREEN].

The start screen is displayed.

5 seconds later, a touch position calibration screen is displayed.

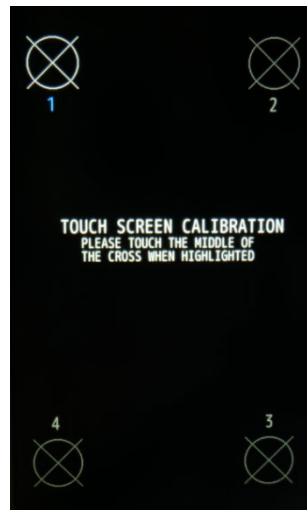

3 Touch the center of the target marks at the four corners of the screen.

Touch the center of the target marks at the four corners in the order from 1 to 4.

The following screen is displayed.



4 Touch the screen for confirmation.

5 When ○ is displayed at the position that was touched:

The adjustment is completed. Close the [TOUCH CAL] menu by touching the [ACCEPT] button.

When the touched position and the position of ○ do not match:

Perform the adjustment again. Touch the [AGAIN] button and restart from Step 2.

4.1.3.2. Maintenance Information

Display the maintenance information.

1 Touch the [MAINT INFO] button in the main menu.

A Maintenance information screen is displayed.

The yellow item is the error.

The green item is the normal.



4.1.3.3. Brightness Adjustment

The brightness of the screen can be adjusted by the time period of a day.

- 2 Touch the [THEME] button in the main menu.

A brightness adjustment screen is displayed.

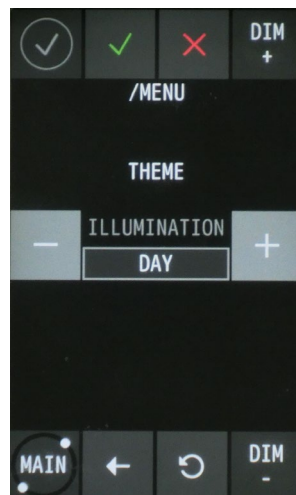

- 3 Change the brightness by touching the [-]/[+] buttons.

DAY: High brightness (for daytime) (default value)

DUSK: Medium brightness (for evening time)

NIGHT: Low brightness (for night time)

- 4 Touch  button to apply and close the [THEME] menu.

4.1.3.4. Date Setting

Information on the year, month, day, and time can be set.

⚠ CAUTION When setting date and time, use UTC (Universal Time Coordinated), not the on-board clock.

In JLN-740, when date and time information is received from GPS, the information is automatically corrected to the received date and time.

1 Touch the [DATE TIME] button in the main menu.

The 1st page of the information setting screen is displayed.

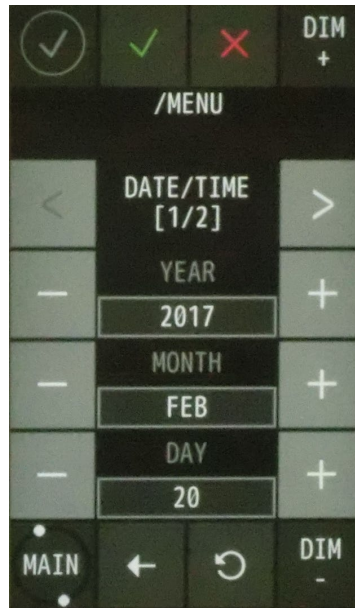

2 Set [YEAR], [MONTH], and [DAY] to the actual values by touching the [-]/[+] buttons.

The setting ranges are as follows.

[YEAR]: 2000 to 2037 (default: 2016)

[MONTH]: JAN to DEC (default: JAN)

[DAY]: 1 to 31 (default: 1)

-
- Turning to page 2 by touching the [>] button.

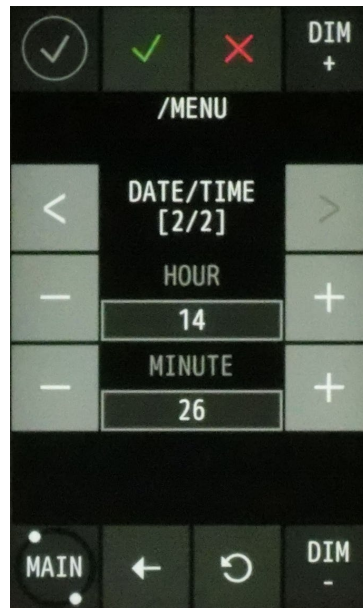

- Set [HOUR] and [MINUTE] to the actual values by touching the [-]/[+] buttons.

The setting ranges are as follows.

[HOUR]: 0 to 23 (default: 0)

[MINUTE]: 0 to 59 (default: 0)

- Confirm the setting and close the [DATE TIME] menu by touching the  button.

Note:

Time will be synchronized when GPS is connected.

If the time difference from GPS is within 1 minute, the time will not be synchronized.

4.1.3.5. Confirming the system information

The information relating to this equipment such as software version can be displayed.

Before making an enquiry on this equipment, check the information of this equipment in the [ABOUT] menu.

1 Touch the [ABOUT] button in the main menu.

Information on the equipment is displayed.



JLN-740A



JLN-741A

2 Close the [ABOUT] menu by touching the  button.

Information that is displayed in the [ABOUT] menu.

The following information is displayed in the [ABOUT] menu.

Information	Description
Display ver. :	Software version of main display. Latest software version at the time of print: V1.002
DP Proc ver. :	Software version of distributed processor. Latest software version at the time of print: R01.01
SP Ctrl ver. :	Software version of signal processor controller Latest software version at the time of print: R01.00
SP Calc ver. :	Software version of signal processor calculator Latest software version at the time of print: R01.00
SP FPGA ver. :	Software version of signal processor FPGA Latest software version at the time of print: R01.00
Display ser.:	Main display serial number. (Note: now displaying only "0000000")
DP ser.:	Serial number of the distribution processor.
SP ser.:	Serial number of the signal processor.
Transducer ser. :	Transducer serial number (Note: An arbitrary serial number of the transducer must be set at installation.)

4.1.3.6. Advanced Settings of the details of the equipment at installation of this equipment

Touch the [ADV SET] button on the main menu. A password input screen is displayed.

This menu is intended for engineers who are to install this equipment. This menu is not for general users.

4.1.3.7. Setting the number of decimal digits of a ship speed

The number of decimal digits can be set for the ship speed that is displayed on the normal screen.

- 1 Touch the [DIGITS] button on the main menu.

A screen for setting the number of decimal digits is displayed.



- 2 Set the number of decimal digits by touching the [-]/[+] buttons.

2: Displays two decimal digits (default value).

1: Displays one decimal digit.

- 3 Close the menu by touching the  button.

4.1.3.8. Ship Speed Unit Settings

The unit of the ship speed that is displayed on the normal screen can be set.

1 Touch the [UNITS] button in the main menu.

A screen for setting a unit is displayed.

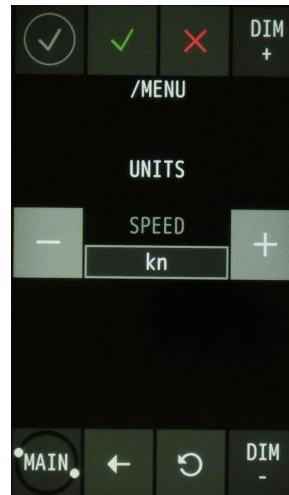

2 Change the unit by touching the [-]/[+] buttons.

kn: knot (default value)

m/s: meter per second

3 Close the [UNITS] menu by touching the  button.

4.1.3.9. Set speed limit and bubble detect level

4.1.3.9.1. Setting the upper limit and the lower limit for ship speed notice

Upper and lower limits of ship speed notice can be set.

When the ship speed exceeds the range of the upper limit or lower limit, a notice is issued.

1 Touch the [SDME] button in the main menu.

2 Touch the [SPEED LIMIT] button.

A screen for setting upper and lower limits of the ship speed is displayed.

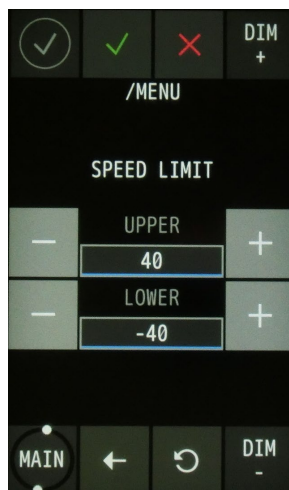

3 When the [-]/[+] button on the screen is touched, each of [UPPER] (upper limit) and [LOWER] (lower limit) decreases/increases. OFF cannot be input with the [-]/[+] button. The [UPPER] cannot be lower than the [LOWER], and the [LOWER] cannot be more than the [UPPER].

-
- 4** Touch the numeric input box of [UPPER] (upper limit) or [LOWER] (lower limit).The numeric entry screen is then displayed.

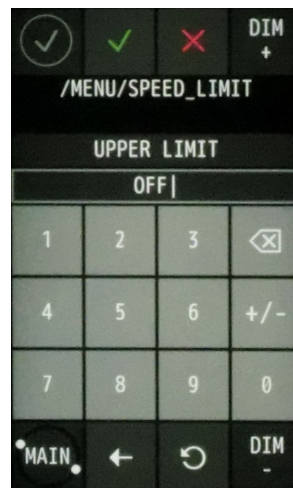

Touch the  button to delete the existing numbers.

When a numeric digit that has been input is deleted, OFF is input.

Enter a numeric digit on the display.

Touch  button to confirm the entry, and close the numeric entry screen.

The setting ranges are as follows.

[UPPER]:-40 to 40, OFF (default: 40)

[LOWER]:-40 to 40, OFF (default: -40)

When this function is set to OFF, no ship speed alert is issued.

- 5** Close the menu by touching the  button.

4.1.3.9.2. Setting the bubble detect level

Bubble detection level can be set. When bubble detection level exceeds the value, a notice is issued

- 1 Touch the [SDME] button in the main menu.
- 2 Touch the [SETT BUBBLE] button.



- 3 When the [-]/[+] button on the screen is touched decreases/increases.

The setting ranges are as follows

[BUBBLE THR.] : 0 to 80000 (default: 50000)

- 4 . Close the menu by touching the  button.

4.1.3.10. SDME Advanced Settings

Touch the [ADV SDME] button on the main menu. A password input screen is displayed.

This menu is intended for engineers who are to install this equipment. This menu is not for general users.

4.1.3.11. Alert List

Among the alerts that are currently issued, the unacknowledged and unrectified alerts are displayed until they are acknowledged and rectified. (Up to 10 alerts can be displayed.)

4

- 1 Touch the [ALERT LIST] button in this main menu.

An alert list is displayed.



- 2 When the list contains multiple pages, the page can be switched by touching the [<]/[>] buttons.
- 3 Close the [ALERT LIST] menu by touching the < button.

4.1.3.12. Alert History

The history of the alert that occurred (sequence of the occurrence, acknowledgment, and rectification).
(Up to 40 alerts can be displayed.)

Rectified alerts are displayed in green.

1 Touch the [ALERT HIST] button in the main menu.

An alert history is displayed.

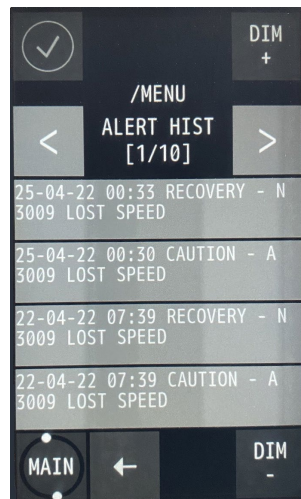

2 When the history covers multiple pages, the page can be switched by touching the [<]/[>] buttons.

3 Close the [ALTER HIST] menu by touching the  button.

4.2. Alert

4.2.1. JLN-740A / JLN-741A Alert list

Alert message	WARNING	CAUTION	Possible cause
LOST SPEED		○	No signal processor data received. The signal processor has failed. Alert will be rectified by normal received from signal processor.

Description of the priority of the alert is described below.

WARNING Although the system is operating normally, the ship speed and distance cannot be measured. Alternatively, this warning is issued when there is a possibility for measurement being disabled.

CAUTION This caution is issued when the product changed to an unintended state.

(This page intentionally left blank)

Chapter 5 Operation Method (JLN-740N/741N)

WARNING



The Doppler log must be used strictly as navigation aid equipment only. The final decision on navigation must be made by the pilot. If the final decision is made based on the information displayed by the Doppler log only, an accident such as collision or grounding may occur.



This equipment must not be used by anyone except the ship's crews and specialized maintenance staff. Failure to comply may result in misuse.

CAUTION



Do not carry out operation of the display unit by a sharp object. Otherwise, the screen may be damaged.



If power outage occurs inside of the ship during the operation of the Doppler log, the image may be disturbed or may not be displayed. In this case, reconnect the power supply.



When the power supply is turned off on the display unit, the equipment then starts when the on-board power supply is turned off/on. This is normal.



If your ship is not on the water such as when it is docked, do not start transmission. Otherwise, the transducer will be damaged.

5.1 Basic Operation

5.1.1 Power Supply ON/OFF



- 1 When the main power supply on the power board is turned on, the display unit power supply is turned on automatically.

If the power has been turned off by pressing  and  simultaneously, the power

can be turned on by pressing .

The power supply is turned on and the start screen is displayed.







JLN-740N

JLN-741N

After 30 seconds, the START TRANSMIT screen is displayed.



When  or  is pressed, the normal screen is displayed. Transmission starts.

When  and  are pressed simultaneously, the power supply is turned off and the screen is cleared.

 **CAUTION** After the start of the equipment, do not shut down until the START TRANSMIT screen is displayed.

5.1.2 Adjusting Brightness

Adjust the brightness to the suitable level for display.

The brightness of the back light can be changed to any of the four levels, bright, medium, dark, and off

by using  .

At the factory shipment, the brightness is set to 'bright'.



5.2 Displaying Ship Speed/Accumulated Sailing Distance

On the normal screen, the fore/after speed and accumulated sailing distance are displayed.

5.2.1 Displaying Ship Speeds



Main Display NWZ-4640

No.	Display	Remarks
[1]	Fore/after speed	When the ship is moving in the ahead direction, ▲ is displayed and when the ship is moving in the astern direction, ▼ is displayed.
[2]	Unit of ship speed	The unit of ship speed can be set to kn or m/s by pressing  . For setting the ship speed unit of the main display, refer to “6.1.3.2 System setting”.

5.2.2 Displaying the Accumulated Sailing Distance

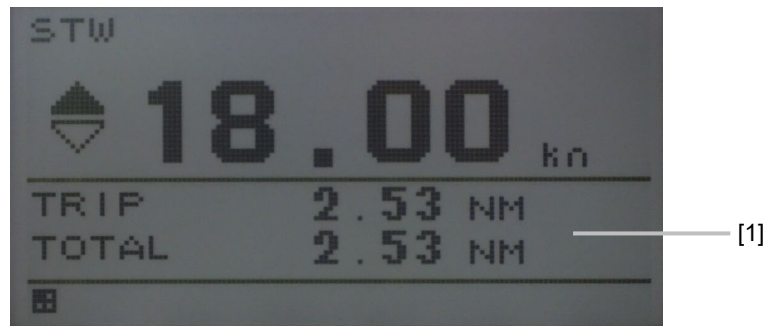

Main Display NWZ-4640

No.	Display/button	Remarks
[1]	Accumulated sailing distance (accumulated sailing distance or trip distance)	<p>[Total] displays the accumulated sailing distance. [Trip] displays the distance of the voyage. When the ship departed point A and returned to point A via point B, point C, and point D as shown below, [Trip] is used to calculate the distance of each section. [Total] (accumulated sailing distance) is used to calculate the total distance.</p> <p>The diagram illustrates a closed loop path on a coastline. Point A is on the left side of the coast, point B is on the top right, point C is on the bottom right, and point D is on the bottom left. Arrows indicate a clockwise path: A to B, B to C, C to D, and D to A.</p>

⚠ CAUTION

Resetting of the accumulated sailing distance is unable to general users.

For resetting the accumulated sailing distance, please request to the store, nearest JRC agent, JRC marine service department, sales department, regional office, branch or sales office.

5.3 Displaying Alert

The Normal icon is displayed while this equipment is functioning normally.

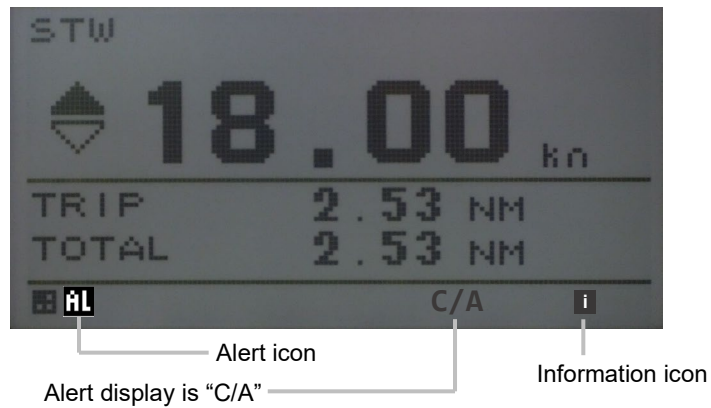

When an alert occurs, the alert occurrence is notified by the popup window.

However, "C/A" is displayed until the alert is rectified.

When the ship water speed cannot be measured, "--.kn" is displayed as the ship speed value.

(This page intentionally left blank)

Chapter 6 Setting by Using Menus (JLN-740N/741N)

On JLN-740N/741N, various configurations can be set and adjusted by pressing the buttons.

CAUTION



Adjustments must be made by specialized service technicians.

Incorrect settings may result in unstable operation, and this may lead to accidents or equipment failure.



Adjust the brightness of main display according to the surrounding lighting.

In NWZ-510SDW, the setting of [NIGHT] may interfere with the recognition of display information.

In NWZ-4640, the setting of [MINIMUM] may interfere with the recognition of display information.

6.1. Setting NWZ-4640

6.1.1. Calling a main menu

Press and hold the  button for 2 seconds..



Main Display NWZ-4640

The main menu is displayed.



Main Display NWZ-4640

The functions of the main menus of the display unit are as follows.

	Menu	Function
1	DISPLAY	Specifies the settings for LCD, click sound, screen selection, and back light color.
2	SYSTEM	Changes system settings. System settings can be changed in maintenance mode only.
3	LANG.	Selects one of the two display languages (English/Japanese).
4	NOTICE	Specifies the settings for Speed notice.
5	SENSOR	Specifies the settings for a sensor. Sensor setting can be changed in maintenance mode only. This menu is not discussed in this instruction manual.
6	DATE - TIME	Sets date and time. (JLN-740N only)
7	ALERT HISTORY	Displays the history of alerts that occurred.
8	ALERT LIST	Displays a list of alerts that are currently occurring.
9	BUBBLE SETTINGS	Bubble detect threshold .
10	MAINT INFO	Displays the maintenance information.

Supplement











When you need to turn off the power, do it after 10 seconds elapse after setting. Otherwise, the set values may not be saved.

6.1.2. Common operations of menu screens

The following buttons perform the common functions for all the menu screens.

(An example of a main menu screen is used for the explanation.)



No.	Name	Function
[1]	 Power/Contrast	Adjust the contrast. To turn off the power, press this key together with the 
[2]	 Dimmer	Use this key to adjust the brightness of the back light.
[3]	 Menu	Use this key to display the Alert list and main menu. Short push to display the active alert list. Two second push to display the main menu.
[4]	 Display	Use this key to switch the display screen.
[5]	 CLR Clear	Use this key to cancel the operation. Use this key also to stop the alert.
[6]	 ENT Enter	Uses this key to determine the operation.
[7]	 Trip reset	Not used on menu screens.
[8]	 Unit	Not used on menu screens.
[9]	 Cursor	Use this key to move the cursor.

6.1.3. Operation of each menu

6.1.3.1. Display setting

When "DISPLAY" is selected on the main menu, a display menu is displayed.

On the display menu, LCD (contrast and back light), click sound, screen selection, and back light colour can be set.

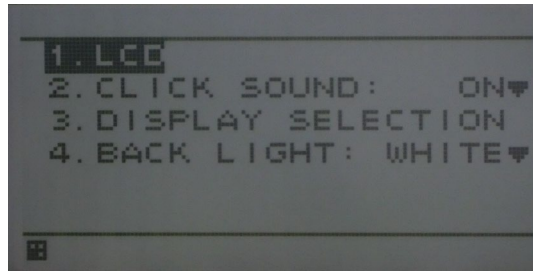





Each submenu is outlined below.

- | | |
|-----------------------|---|
| 1) LCD: | Adjusts the contrast and sets the back light level. |
| 2) CLICK SOUND: | Turns on/off the click sound. |
| 3) DISPLAY SELECTION: | Selects a screen. |
| 4) BACK LIGHT: | Selects a back light colour (white/orange). |

6.1.3.1.1. Adjusting contrast





- Adjust the LCD contrast.
- When the contrast adjustment value is set to 1, the display density is highest and when the value is set to 13, it is lowest.
- The default setting is 7.

- 1** Display a main menu by pressing  for two second.
- 2** Select "DISPLAY", "LCD", and "CONTRAST" in this order by using .
- 3** Enter a contrast value by using  and press .

6.1.3.1.2. Adjusting back light

- Brightness of the back light can be changed by using . Four levels of brightness are available: bright, medium, dark, and off.

This section shows how to set a value of each brightness level.

- 1 Display a main menu by pressing  for two second.
- 2 Select “DISPLAY”, “LCD”, and “DIMMER MAXIMUM/TYPICAL/MINIMUM” in this order by using .
- 3 Enter a brightness level value by using  and press .

Supplement





Enter the highest value in “MAXIMUM” and the lowest value in “MINIMUM”.

6.1.3.1.3. Setting a click sound

- Turn on/off a key-operation click sound.

ON: Enables a click sound. When the key is pressed, a “pip” sound is emitted. When the operation is invalid, a “pip pip pip” sound is emitted.

OFF: Disables a click sound.

- 1 Display a main menu by pressing  for two second.
- 2 Select “DISPLAY” and “CLICK SOUND” in that order by using .
- 3 Select “ON” or “OFF” by using and  press .

6.1.3.1.4. Setting a display screen

Up to six display screens can be registered in this display unit.

The display screen can be switched either manually by using  or automatically (auto screen function).

The auto screen function enables the setting of a switching interval. Switching can also be notified by emitting a sounder.

Only the integer section or the decimal section of an indication character can be expanded and displayed. (Display mode)

Set the auto screen function and the display mode in "STEP3."

The screen structures of each display screen include customised screens that can be set freely, special screens that do not allow any setting, and graphic screens. The contents to be displayed on the display screen can be selected.

The screen selection procedure is as follows.

STEP1 Select a display screen.





STEP2 Select a screen structure.

STEP3 Select the display contents.

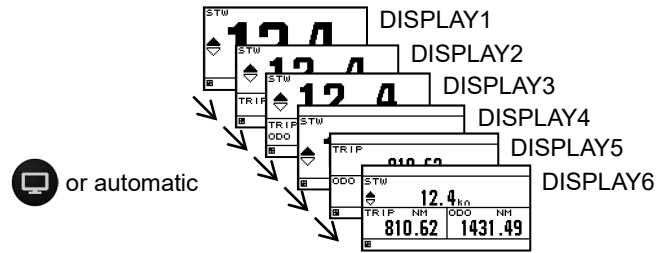
6.1.3.1.4.1. STEP1 Selecting a display screen

Up to six display screens can be registered in this display unit.



- 1 Display a main menu by pressing  for two seconds (normal mode).
- 2 Select "DISPLAY" and "DISPLAY SELECT" in that order by using  and press .
- 3 Select a display screen from "DISPLAY1" to "DISPLAY6" by using  and press .

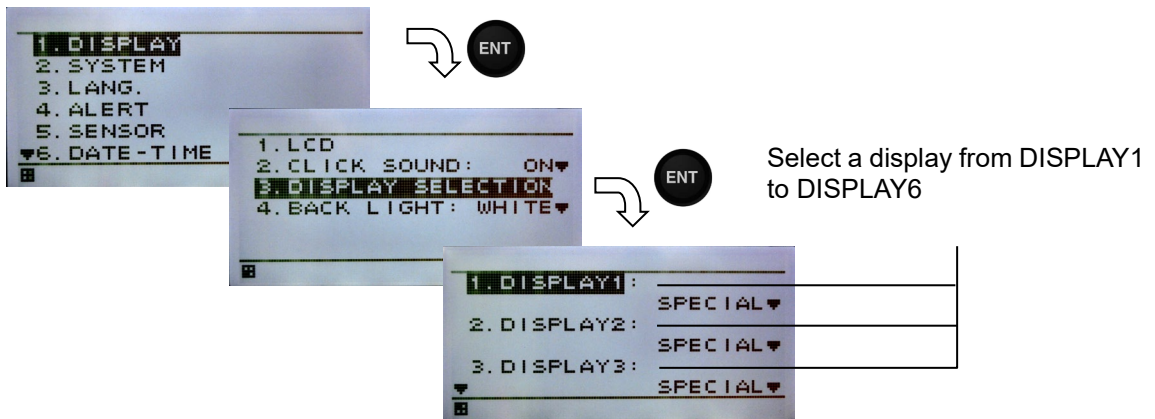

6.1.3.1.4.2. STEP2 Selecting a screen structure

The screen structures of each display screen include customised screens that can be set freely, special screens that do not allow any setting, and graphic screens.

Select a screen structure.

When display structure selection is set to “OFF”, the display screen cannot be registered.

Customised screen

One screen can be segmented into screens 1 to 4. Up to four contents can be displayed concurrently.



Special screen and graphic screen

Users cannot change the screen structure. Special contents for the model are displayed on the screen.

The following screen structures can be selected.

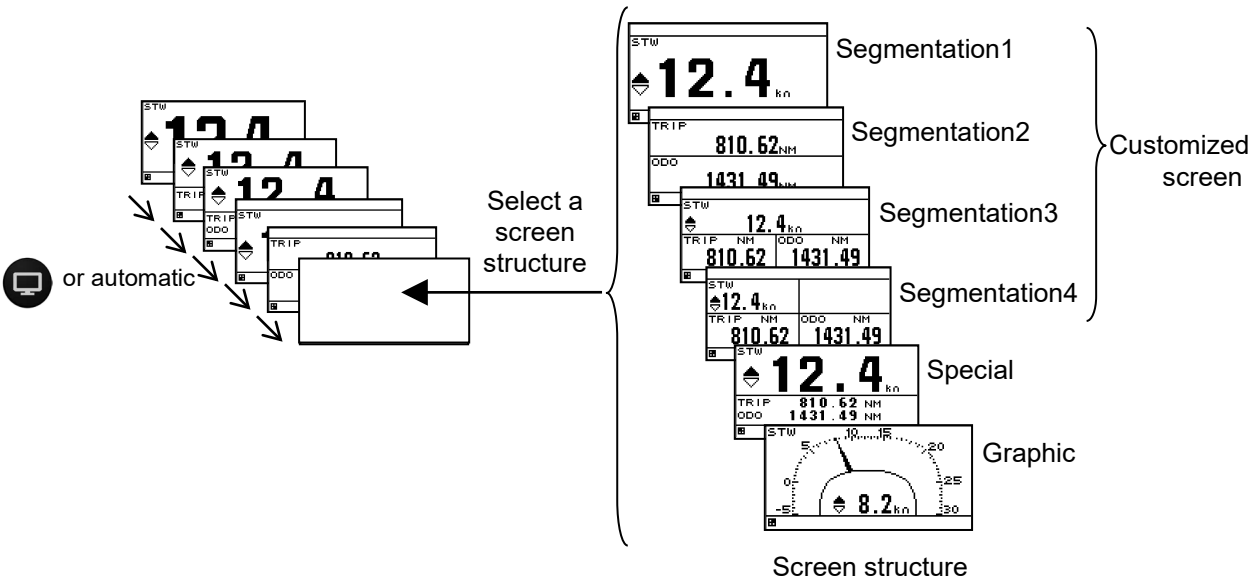
- 1) SEGMENTATION1: Full screen
- 2) SEGMENTATION2: The screen is segmented into two sections.
- 3) SEGMENTATION3: The screen is segmented into three sections.
- 4) SEGMENTATION4: The screen is segmented into four sections.
- 5) SPECIAL: Special Doppler log screen
- 6) GRAPHIC: Graphic screen



-
- 1 Select a display screen by referencing "STEP1".
 - 2 Select a screen structure from "SEGMENTATION1", "SEGMENTATION2", "SEGMENTATION3", "SEGMENTATION4", "SPECIAL", "GRAPHIC" and "OFF" by using  and press .

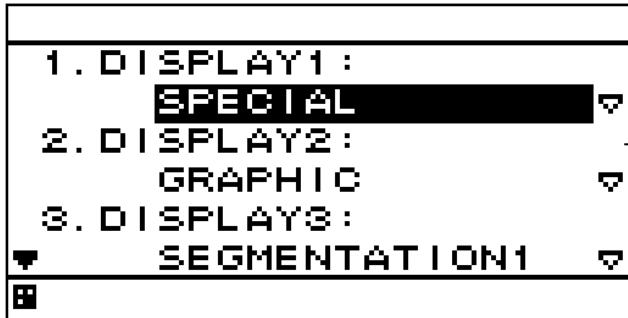

Select
SEGMENTATION1,
SEGMENTATION2,
SEGMENTATION3,
SEGMENTATION4,
SPECIAL, GRAPHIC,
or
OFF.

6.1.3.1.4.3. STEP3 Selecting display contents

Select as many display contents as the number of screens that are created by segmentation.
 For instance, for a 2-segmentation screen, select the display content for one half of the screen and then select the display content for the other half of the screen (see the diagram below).

First select Doppler on the customised screen, and, next, select the display contents.

Only the integer section or a decimal section of some item that is selected on a 1-segmentation customised screen or a special screen can be expanded.

If display content selection is set to “OFF”, no information is displayed in the area.

Set the auto screen function and display mode in STEP3. The following functions can be set.

- 1-1) AUTO SCREEN: ON – Enables the auto screen function.
 OFF – Disables the auto screen function.
- 1-2) SOUND: SOUND 1 – Emits a sounder “pip pip” when the screen is switched.
 SOUND 2 – Emits a sounder “pip” when the screen is switched.
 OFF – Does not emit a sounder even if the screen is switched.
- 1-3) TIME: Set a screen switching time. A time of up to 10 seconds can be set.
- 2-1) DISPLAY MODE: Normal: Displays in the character of the same size.
 Special 1: Only integer part is expanded and displayed.
 Special 2: Only a decimal part is expanded and displayed.
 Auto range: Integer part or a decimal part is expanded for the optimum display.

Example) Procedure for selecting display contents for a 2-segmentation screen

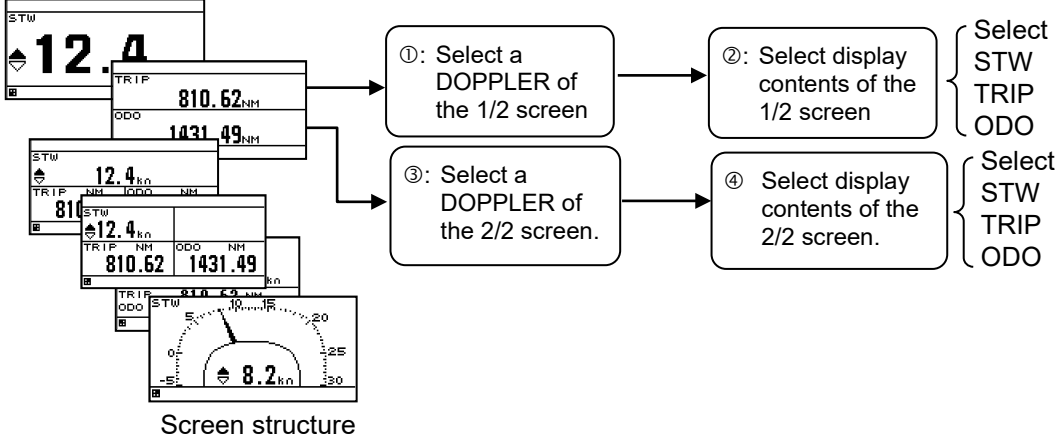

- 1 Select a screen structure by referencing “STEP1” and “STEP2”.

Customized screen

- 2 Select a screen section to be displayed by using  and press .

Select the screen section from the following:





1-segmentation screen: “DISPLAY”

2-segmentation screen: “DISPLAY 1/2” “DISPLAY 2/2”

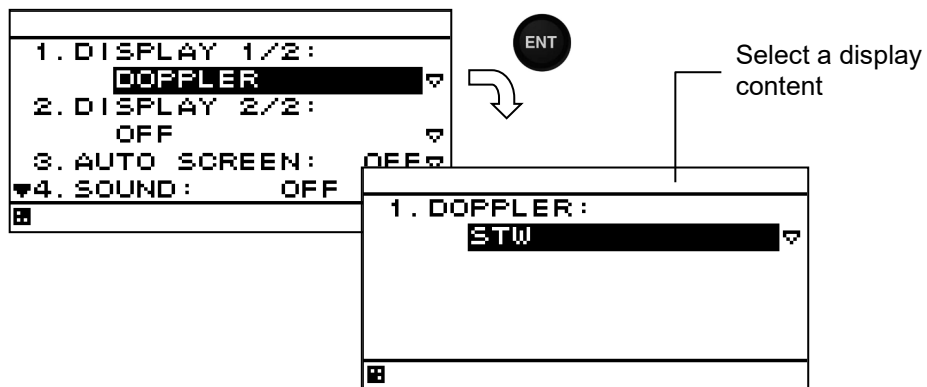



3-segmentation screen: “DISPLAY 1/3” “DISPLAY 2/3” “DISPLAY 3/3”

4-segmentation screen: “DISPLAY 1/4” “DISPLAY 2/4” “DISPLAY 3/4” “DISPLAY 4/4”



- 3 Select “DOPPLER” by using  and press .
- 4 Select display contents by using  and press .
- 5 Go to procedure 6 when setting an auto screen.

Special screen and graphic screen

- 2 Select “DISPLAY” by using  and press .
- 3 Select display contents by using  and press .
- 4 Go to procedure 6 when setting an auto screen.

Display structure and display contents

Display structure	Display	Display contents
Segmentation 1, 2, 3, 4	DOPPLER/OFF	Fore/after STW, TRIP, ODO(Odometer)
Special screen	-	STW 1/2/3
Graphic screen	-	STW ship speed
OFF	-	-

Setting an auto screen

On an auto screen, set a screen switching time and whether a sounder is emitted at screen switching.



- 6 Select "ON" or "OFF" under "AUTO SCREEN" by using and press .
- 7 Select "SOUND1", "SOUND2", or "OFF" by using and press .
- 8 Select "TIME" by using .
- 9 Enter a switching time by using and press .

Starting an auto screen

- 1 Set an auto screen to "ON" in advance to make an auto screen available.
- 2 Press for one second or longer.

Stopping an auto screen

- 1 Press to stop an auto screen. An auto screen can also be stopped by using a key other than and .

Setting a display mode





The display mode can be set only with segmentaion1 screen.

The contents of a display with an effective auto range are STW, trip distance, and accumulated sailing distance .

An auto range changes a display in the following range.

Auto range

Display contents	Integer part expanded display (special 1)	Normal display	Integer part expanded display (special 2)
STW	10.0kn or more	1.0 to 9.9kn	0.9kn or less
Accumulated sailing distance/trip distance	10.00NM or more	1.00 to 9.99NM	0.99NM or less

- 1 Set the display contents by using the procedure described above.
- 2 Select “DISPLAY MODE” by using  and press .
- 3 Select “NORMAL”, “SPECIAL1”, “SPECIAL2”, or “AUTO RANGE” by using  and press .

STW display example

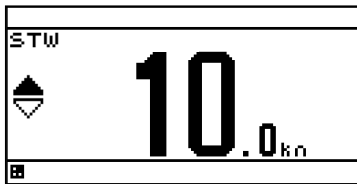

Integer part expanded display

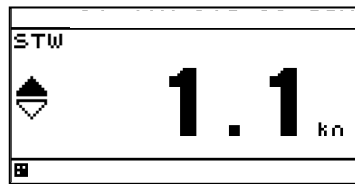

Normal display

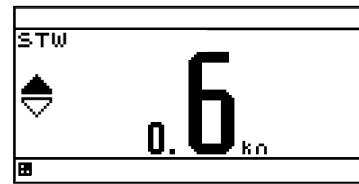

Decimal part expanded display

6.1.3.1.5. Select a back light color

White or orange can be selected as the back light color of the screen that is normally used.

- 1 Display a main menu by pressing  for two second.
- 2 Select “DISPLAY” and “BACK LIGHT” in that order by using .
- 3 Select “WHITE” or “ORANGE” by using  and press .

6.2. System setting

Users can check the speed unit, smoothing time and digit of speed.

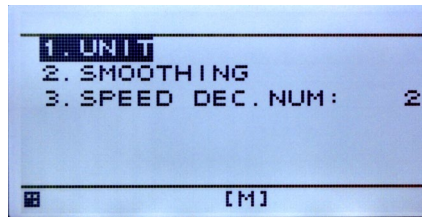

To select the speed unit, press  to alternate “kn” and “m/s”. (see 5.2.1) If you need to change other system settings, enter the service engineer menu. (see 6.10)

6.3. Language setting

Users can check the language setting.

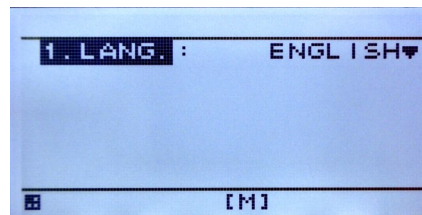

If you need to select the language between English and Japanese, enter the service engineer menu. (see 6.10)

6.4. Speed notice setting



Users can set the Speed notice. Setting item is 1. Maximum speed, 2. Minimum speed and ON/OFF. If the vessels speed is over then “OVER SPEED STW” notice would occur.

1 Display a main menu by pressing the  button for two second. (normal menu)

2 Select “NOTICE” and “SPEED” by using  and .

3 Select “MAXIMUM” or “MINIMUM” by using  and .

4 When select “ON”, the notice value setting is enable. The value is from -40kn to +40kn.

5 To memory the setting value, select “CONFIRM” by using  and .

6 IF set the maximum value to “ON”, “OVER SPEED STW” notice would occur with over the set value.

ex) Set value: +20kn notice would occur over 20.1kn forward.

7 IF set the minimum value to “ON”, “OVER SPEED STW” notice would occur with over the set value.

ex) Set value: -20kn notice would occur over 20.1kn backward.

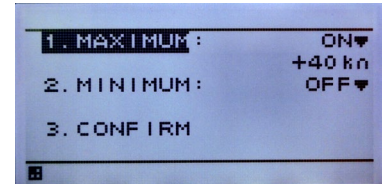

6.5. Sensor setting

Users can check the speed correction rate, NMEA setting, speed pulse output and analog meter full scale.



If you need to change sensor settings, enter the service engineer menu. (see 6.10)
On JLN-741N sensor setting menu, only speed correction rate is displayed.

6.6. Date and time setting

Only JLN-740N is displayed this menu. Users can check system clock date and time.

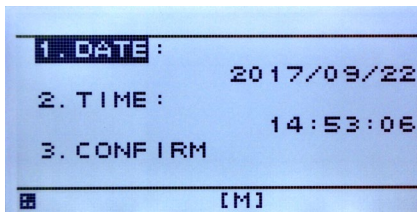





If you need to change date and time settings, enter the service engineer menu. (see 6.10)

Note: Time will be synchronized when GPS is connected. If the time difference from GPS is within 1 minute, the time will not be synchronized.

6.7. Alert history display

The alert history would display. Total 40 alert history would display. On JLN-740N, menu number is "7".
On JLN-741N, menu number is "6".

- 1 Display a main menu by pressing the  button for two second. (normal menu)
- 2 Select "ALERT HISTORY" by using  and .
- 3 It is possible to check the history of up to 40 by pressing the .
- 4 If the number of characters in each history is large, you can check the whole message by pressing the .

JLN-740N Alert history display example

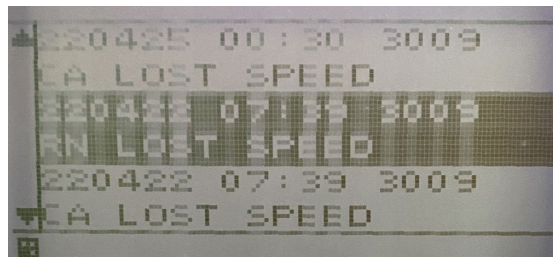

For the displayed contents, see section 6.11.

6.8. Alert list display

- 1 Display a main menu by pressing the  button.

The alerts that are currently occurring will be displayed until they are restored.

In the JLN - 740N, 8. alert list is displayed, in JLN - 741N, 7. alert list is displayed.

JLN-740N Alert list display example

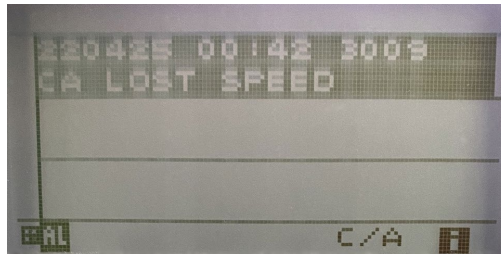





For the displayed contents, see section 6.9.5. The display contents of JLN - 741N are different.

6.9. Bubble settings display.

The bubble threshold is set bubble detection value.

Set value is 0 to 80000. default value is 50000.

- 2 Display a main menu by pressing the  button for two second. (normal menu)
- 3 Select "BUBBLE SETTINGS" by using  and  .
- 4 Set value by using  and  .

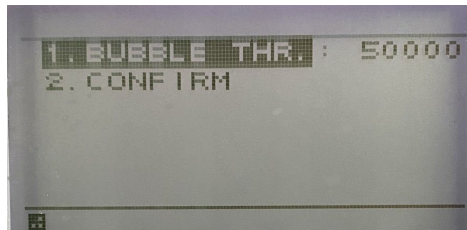

6.10. MAINT INFO display

Display maintenance information. Do not support JLN-741N.

- 1 Display a main menu by pressing the  button for two second. (normal menu)
- 2 Select "MAINT INFO." by using  and  .

Occurred
datetime

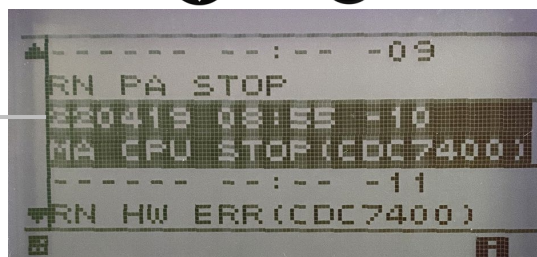

6.11. Alert

No signal processor data received.

If an error is found, an alert message is displayed on the LCD screen.

The alert icon display will not be lost until the alert is restored.

In this chapter, state transition diagram, alert list, ID list are shown as explanation of alert in general.

Below is a list of possible causes of alert items.

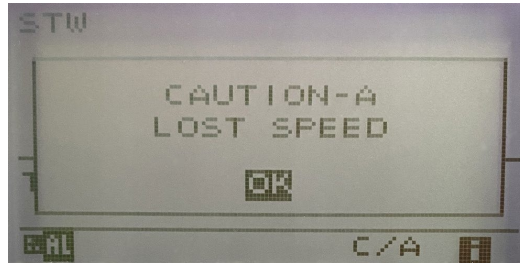

The alert types displayed are as follows.

JLN-740N / JLN-741N Alert List

Pop up message	Criteria	ID	Priority	Possible Causes / Guidance
LOST SPEED	IEC 62923-2 Table A.1	3009	Caution	No signal processor data received. The signal processor has failed. Alert will be rectified by normal received from signal processor.

6.11.1. General state transition of the alerts

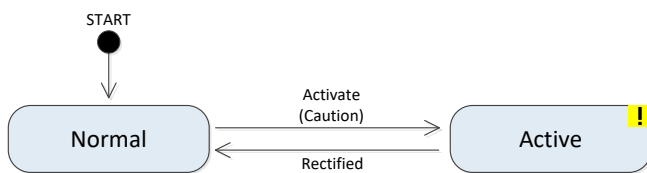

Status	Caution
Normal	(none)
Active Acknowledged	!

6.11.2. Alerts that occur in JLN-740N / JLN-741N

Alert message	WARNING	CAUTION	Possible Cause
LOST SPEED		○	No signal processor data received. The signal processor has failed. Alert will be rectified by normal received from signal processor.

Description of the priority of the alert is described below.

WARNING Although the system is operating normally, the ship speed and distance cannot be measured. Alternatively, this warning is issued when there is a possibility for measurement being disabled.

CAUTION This caution is issued when the product changed to an unintended state.

6.12. Display of alert list · history screen

On the alert history screen, an example of caution display (JLN-740N)

Active Caution [LOST SPEED] → Rectified

It is lining up so that new alert history is above.

In JLN - 741N, the date and time of occurrence, ID is blank.

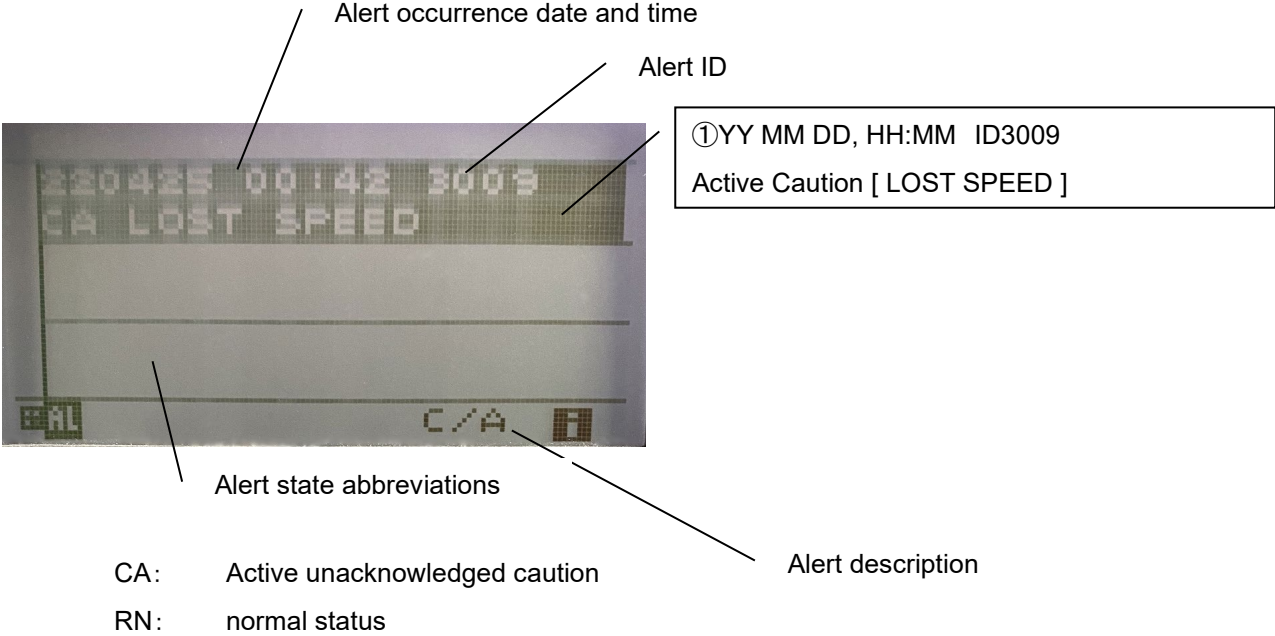





Attention level, " acknowledged " is unnecessary, attention occurrence, there is no " acknowledged " state.

6.13. Installation setting

CAUTION

Maintenance menu includes system settings of JLN-740N / 741N.
Never change anything other than those described in this chapter.
Changing it may cause malfunction or failure.

- 1 Display a main menu by pressing the  button for two second. (normal menu)
- 2 When  and  are press and hold for 3 seconds (shift to Equipment Mode).
- 3 To return to the normal mode, press  and  at the same time for 3 seconds, the [M] at the bottom of the menu screen disappears. (Normal mode) Even if you leave the menu open for 3 minutes, it returns to normal mode.

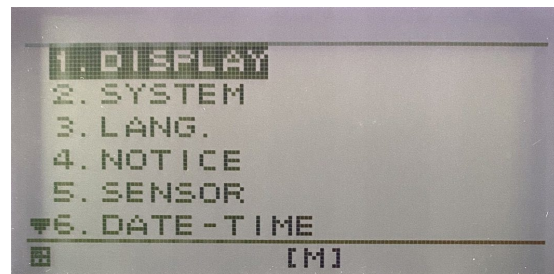
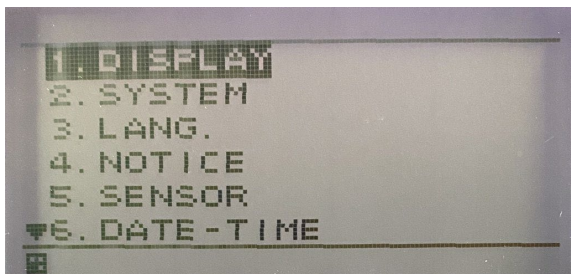

Note: In the maintenance mode, alert history and alert list are not displayed.

6.13.1. System setting

2. In the equipment setting mode of the system setting, you can set the speed unit, the smoothing time constant, and the number of decimal places of the speed display.

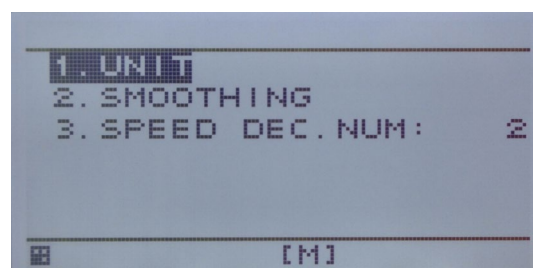

The speed unit can be switched kn and m / s and is explained in 5.2.1.

It is also possible by the method pressing the  button.

Smoothing can be switched from 1 to 60 seconds.

The number of decimal places in ship speed display can be switched between 1 and 2 digits.

6.13.2. Language setting

3. In Maintenance mode of language setting, [ENGLISH] · [JAPANESE] can be switched.

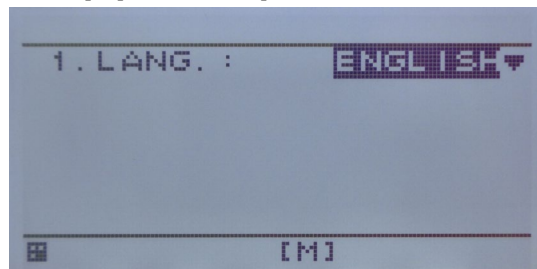

6.13.3. Sensor setting

5. In the sensor setting mode of sensor setting, you can set the boat speed correction value, serial output setting, pulse output setting, and scale setting of the analog meter.

Please do not change usually because it is related to equipment operation.

For JLN - 741N only ship speed correction value can be set, other items are blank.

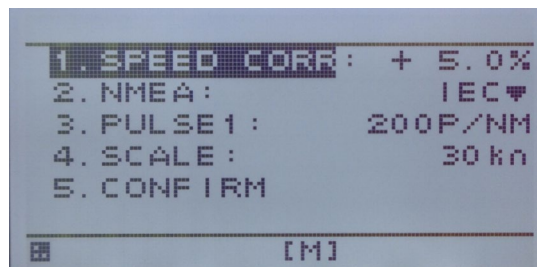

6.13.4. Date setting

It is a menu displayed only in JLN - 740N.

6. In the date / time setting maintenance mode, you can set the date and time of the system clock.

As it is related to the alert data delivery date and time to the peripheral device, Normally do not change



Chapter 7 Operation Method (Option)

WARNING



The Doppler log must be used strictly as navigation aid equipment only. The final decision on navigation must be made by the pilot. If the final decision is made based on the information displayed by the Doppler log only, an accident such as collision or grounding may occur.



This equipment must not be used by anyone except the ship's crews and specialized maintenance staff. Failure to comply may result in misuse.

7

CAUTION



Do not carry out operation of the display unit by a sharp object. Otherwise, the screen may be damaged.



If power outage occurs inside of the ship during the operation of the Doppler log, the image may be disturbed or may not be displayed. In this case, reconnect the power supply.



When the power supply is turned off on the display unit, the equipment then starts when the on-board power supply is turned off/on. This is normal.

7.1 Basic Operation

7.1.1 Adjusting Brightness

Adjust the brightness to the suitable level for display.

Adjust the brightness by touching the [DIM+] button/[DIM-] button on the display.

The brightness is set to maximum initially.

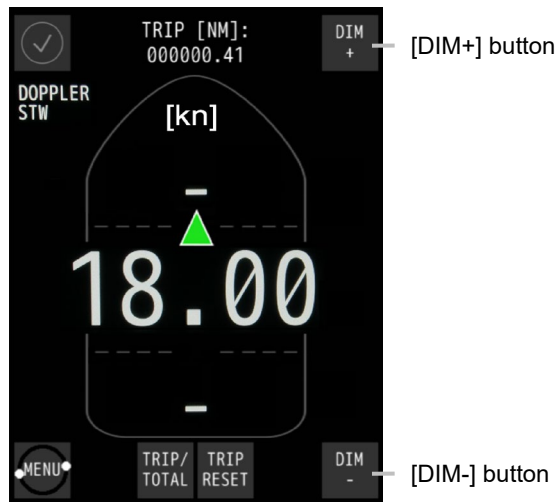

Remote Display NWZ-650SDR (Optional)



Remote Display NWZ-840SDR (Optional)

When the [DIM+] button is touched, the display brightness increases and the display can be dimmed by touching the [DIM-] button.

17 brightness levels are available.

CAUTION

Under the minimum brightness, the ship speed display and the accumulated sailing distance/trip distance display disappear.



Multi-information Display NWZ-4610 (Optional)

The brightness of the backlight can be adjusted to four levels, DAY, DUSK, NIGHT, and OFF by pressing .

At the factory shipment, the brightness is set to DAY.

7.2 Displaying Ship Speed/Accumulated Sailing Distance

On the normal screen, the fore/after speed and accumulated sailing distance are displayed.

7.2.1 Displaying Ship Speeds

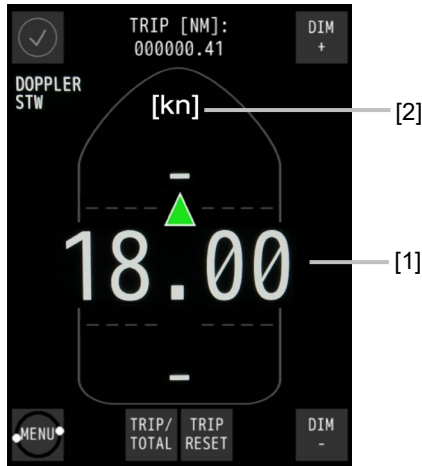

Remote Display NWZ-650SDR (Optional)



Remote Display NWZ-840SDR (Optional)

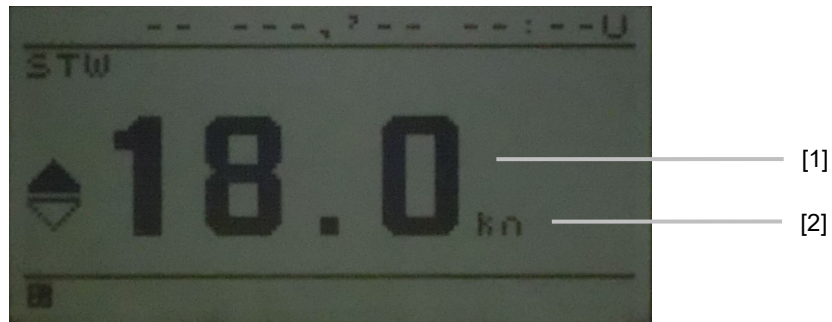

Multi-information Display NWZ-4610 (Optional)

No.	Display	Remarks
[1]	Fore/after speed	When the ship is moving in the ahead direction, ▲ is displayed and when the ship is moving in the astern direction, ▼ is displayed.
[2]	Ship speed unit	The unit of ship speed can be set to kn or m/s by operating the menu.

7.2.2 Displaying the Accumulated Sailing Distance



Remote Display NWZ-650SDR (Optional)



Remote Display NWZ-840SDR (Optional)

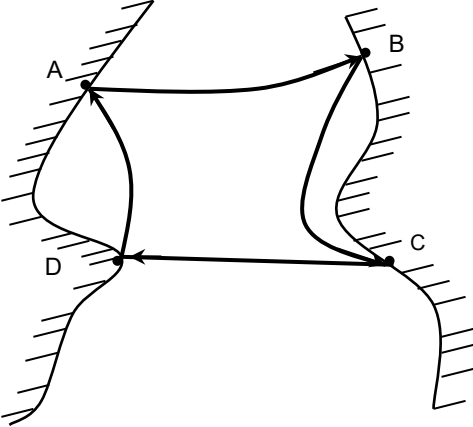

Distance Counter NWW-7 (Optional)

No.	Display/button	Remarks
[1]	Sailing distance (accumulated sailing distance or trip distance)	<p>Whenever the [TRIP/TOTAL] button is touched, the display changes between the total sailing distance and section sailing distance.</p> <p>As shown below, when a ship leaves point A, stopover at points B, C, and D, then goes back to point A, the [TRIP] (trip distance) is used to calculate the distance of each of the individual segments between the point.</p> <p>For [TOTAL] (accumulated sailing distance), it is used for calculation of the total distance.</p> 
[2]	[TRIP/TOTAL] button	Whenever the button is touched, the display is switched between the accumulated sailing distance and the trip distance.
[3]	[TRIP RESET] button	<p>When this button is touched, a confirmation window is displayed.</p> <p>When the [✓] button is touched, the section sailing distance is reset to 0.</p> <p>When the [✕] button is touched, the normal screen is displayed.</p>
[4]	TRIP	Displays the trip distance only.

CAUTION

Resetting of the accumulated sailing distance is unable to general users.

For resetting the accumulated sailing distance, please request to the store, nearest JRC agent, JRC marine service department, sales department, regional office, branch or sales office.



Multi-information Display NWZ-4610 (Optional)

No.	Display/button	Remarks
[1]	Sailing distance (accumulated sailing distance or trip distance)	<p>[Total] displays the accumulated sailing distance. [ODO] displays the distance of the voyage. As shown below, when a ship leaves point A, stopover at points B, C, and D, then goes back to point A, the [ODO] (trip distance) is used to calculate the distance of each of the individual segments between the point. For [TOTAL] (accumulated sailing distance), it is used for calculation of the total distance.</p>

Resetting trip distance, refer to section 4.5.8 of NWZ-4610 instruction manual.

⚠ CAUTION

Resetting of the accumulated sailing distance is unable to general users.

For resetting the accumulated sailing distance, please request to the store, nearest JRC agent, JRC marine service department, sales department, regional office, branch or sales office.

7.3 Displaying Alert

The Normal icon is displayed while this equipment is functioning normally.

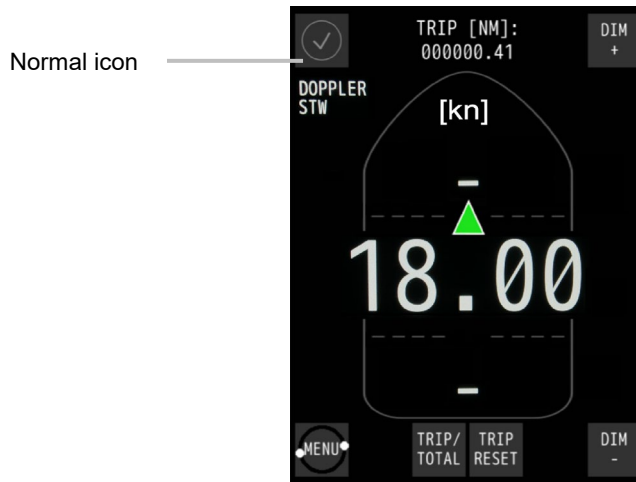

Remote Display NWZ-650SDR (Optional)



Remote Display NWZ-840SDR (Optional)

For the occurrence of alert, refer to “3.3 Alert display” (JLN-740A/741A) or “5.3 Alert display” (JLN-740N/JLN-741N).

Alert of the NWZ-4610 is refer to NWZ-4610 instruction manual.

Chapter 8 Setting by Using Menus (Option)

In NWZ-650SDR/840SDR, various settings and adjustments can be performed by using the menus that are displayed.

On NWZ-4610, various configurations can be set and adjusted by pressing the buttons.

CAUTION



Adjustments must be made by specialized service technicians.
Incorrect settings may result in unstable operation, and this may lead to accidents or equipment failure.



Adjust the brightness of main display according to the surrounding lighting.
In NWZ-650SDR/840SDR, the setting of [NIGHT] may interfere with the recognition of display information.
In NWZ-4610, the setting of [MINIMUM] may interfere with the recognition of display information.

8.1. Setting of NWZ-650SDR/840SDR

8.1.1. Main Menu

Touch the [MENU] button on the normal screen.

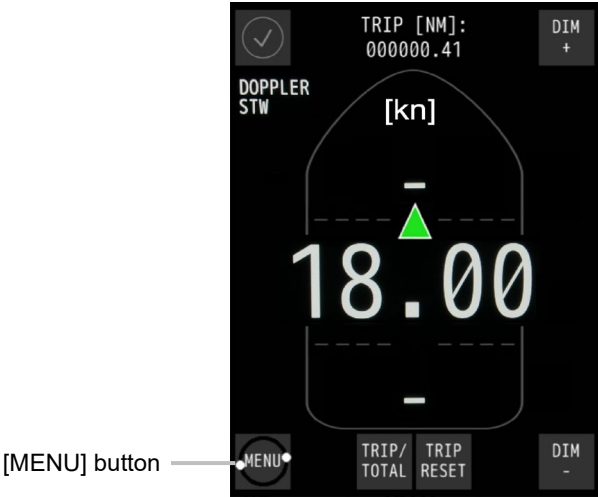

Remote Display NWZ-650SDR (Optional)



Remote Display NWZ-840SDR (Optional)

The main menu is displayed.

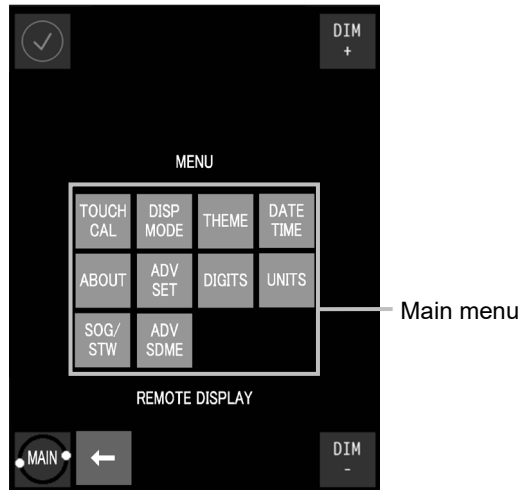

Remote Display NWZ-650SDR (Optional)

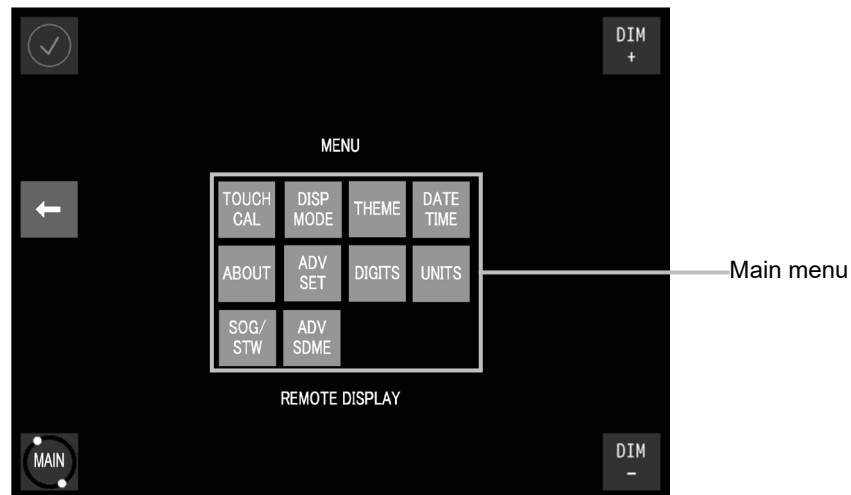

Remote Display NWZ-840SDR (Optional)

The functions of sub-display menus are as follows.

Menu	Function
[TOUCH CAL] (Touch position calibration)	Adjusts the shift of the display position.
[DISP MODE] (Display mode selecting)	Selecting the display mode of remote display.
[THEME] (Brightness adjustment)	Set the brightness of the display to DAY, DUSK, or NIGHT.
[DATE TIME] (System clock adjustment)	Set up the system clock; YEAR/ MONTH/ DAY/ HOUR/ MINUTE.
[ABOUT] (Information on this equipment)	Displays the information relating to this equipment such as the software version.
[ADV SET] (Advanced setting)	Menu for relevant engineers only. This function is not used by general users.
[DIGITS] (Number of speed indication digits)	Selecting the number of digits for ship speed indication.
[UNITS] (Unit setting)	Select the unit of the ship speed that is displayed on the normal screen.
[SOG/STW] (SOG and STW selecting)	Selecting the display speed between SOG and STW.
[ADV SDME] (Advanced setting of this equipment)	Menu for relevant engineers only This function is not used by general users.

8.1.2. Operation of Each Menu

8.1.2.1. Touch Position Calibration

When the touched position and the intended button do not match when the screen is touched, adjust the touched position in this menu.

- 1 Touch the [TOUCH CAL] button in the main menu.**
A touch position calibration confirmation screen is displayed.
- 2 Touch [CONFIRM CALIBRATE THE TOUCH SCREEN].**
The start screen is displayed.
5 seconds later, a touch position calibration screen is displayed.
- 3 Touch the center of the target marks at the four corners of the screen.**
Touch the center of the target marks at the four corners in the order from 1 to 4.
The following screen is displayed.
- 4 Touch the screen for confirmation.**
- 5 When ○ is displayed at the position that was touched:**
The adjustment is completed. Close the [TOUCH CAL] menu by touching the [ACCEPT] button.
When the touched position and the position of ○ do not match:
Perform the adjustment again. Touch the [AGAIN] button and restart from Step 2.

8.1.2.2. Brightness Adjustment

The brightness of the screen can be adjusted by the time period of a day.

- 1 Touch the [THEME] button in the main menu.**
A brightness adjustment screen is displayed.
- 2 Change the brightness by touching the [-]/[+] buttons.**
DAY: High brightness (for daytime) (initial value)
DUSK: Medium brightness (for evening time)
NIGHT: Low brightness (for night time)
- 3 Touch  button to apply and close the [THEME] menu.**

8.1.2.3. Date Setting

Information on the date and time of the remote display can be set in this menu according to the actual information.

- 1 Touch the [DATE TIME] button in the main menu of remote display.
- 2 Set [YEAR], [MONTH], and [DAY] to the actual values by touching the [-]/[+] buttons.

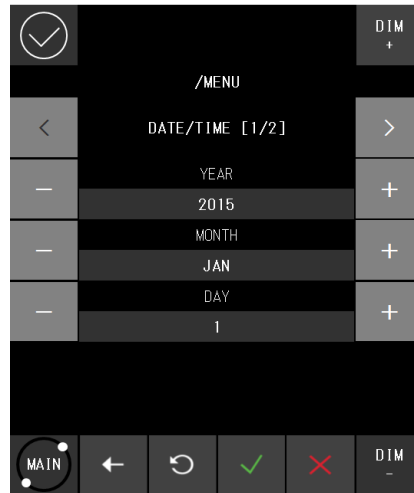

The setting ranges are as follows.

[YEAR]: 2000 to 2099 (initial value: 2015)

[MONTH]: JAN to DEC (initial value: JAN)

[DAY]: 1 to 31 (initial value: 1)

- 3 Turning to page 2 by touching the [>] button.

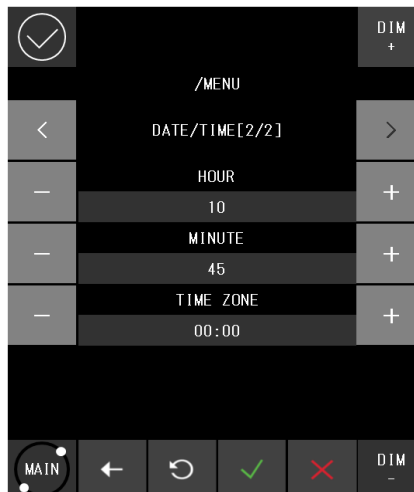

4. Set [HOUR], [MINUTE] and [TIME ZONE] to the actual values by touching the [-]/[+] buttons.

The setting ranges are as follows.

[HOUR]: 0 to 23 (initial value: 0)

[MINUTE]: 0 to 59 (initial value: 0)

[TIME ZONE]: -12:00 to +12:00 (initial value: 00:00)

5. Confirm the setting and close the [DATE TIME] menu by touching the  button.

8.1.2.4. Confirming the system information

The information relating to this equipment such as software version can be displayed.

Before making an enquiry on this equipment, check the information of this equipment in the [ABOUT] menu.

- 1 Touch the [ABOUT] button in the main menu.**
Information on the equipment is displayed.
- 2 Close the [ABOUT] menu by touching the  button.**

Information that is displayed in the [ABOUT] menu.

The following information is displayed in the [ABOUT] menu.

Information	Description
MF ver. :	Software version of remote display. Latest software version at the time of print: V1.026
MF ser. :	Serial version of distributed processor.

8.1.2.5. Advanced Settings of the details of the equipment at installation of this equipment

Touch the [ADV SET] button on the main menu. A password input screen is displayed.

This menu is intended for engineers who are to install this equipment. This menu is not for general users.

8.1.2.6. Display Mode Selection

Display mode of the remote display can be changed.

- 1 Touch the [DISP MODE] button in the main menu of remote display.
- 2 Display mode setting screen is then displayed. Set the display mode by touching the [-]/[+] buttons.

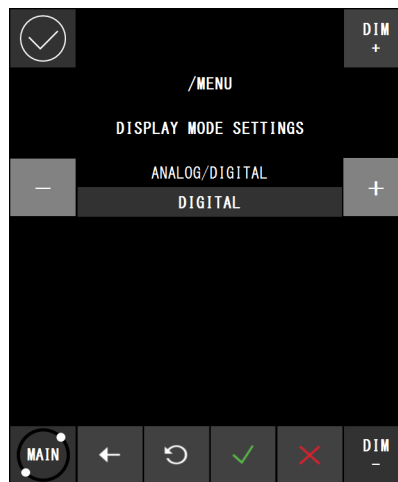

DIGITAL: Display in digital mode (initial value)

ANALOG: Display in analog mode

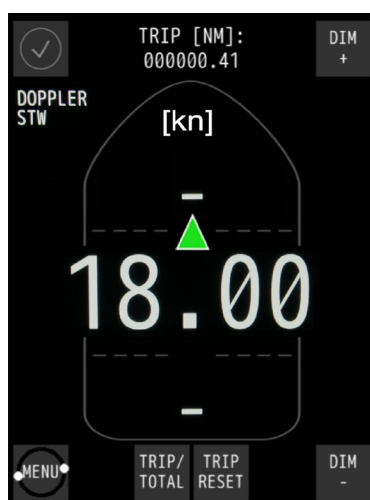

Display in digital mode

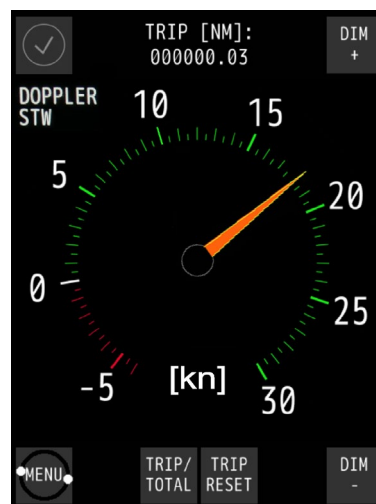

Display in analog mode

- 3 Confirm the setting and close the [DISP MODE] menu by touching the  button.

8.1.2.7. Ship Speed Unit Settings

The unit of the ship speed that is displayed on the normal screen can be set.

1 Touch the [UNITS] button in the main menu.

A screen for setting a unit is displayed.

2 Change the unit by touching the [-]/[+] buttons.

kn: knot (initial value)

m/s: meter per second

3 Close the [UNITS] menu by touching the  button.

8.1.2.8. Advanced SDME Settings

Touch the [ADV SDME] button on the main menu. A password input screen is displayed.

This menu is intended for engineers who are to install this equipment. This menu is not for general users.

8.1.2.9. SOG and STW selection

The speed over the ground and the speed through the water of the remote display can be selected.

- 1 Touch the [SOG/STW] button in the main menu of remote display.
- 2 SOG/STW setting screen is then displayed. Touch the [-]/[+] buttons to switch the SOG and STW of the remote display

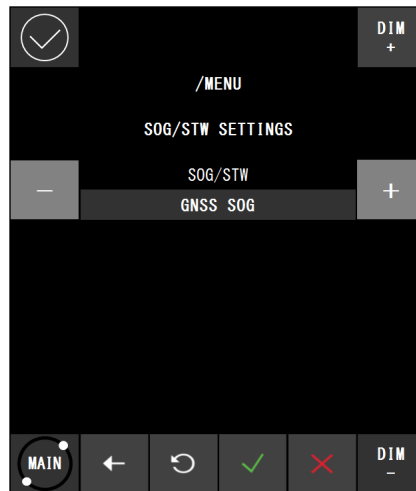

GNSS SOG: Speed over the group by the satellite log (initial value)

DOPPLER SOG: Display the ship speed over the ground from the Doppler.

DOPPLER STW: Display the ship speed through water from the Doppler.

- 3 Confirm the setting and close the [SOG/STW] menu by touching the  button.

8.2. Setting of NWZ-4610

The setting of NWZ-4610 is written in the manual of NWZ-4610 from section 4.2 to 4.8.5.

Chapter 9 Installation Method

CAUTION



Electrical work for this equipment must be requested to the store, nearest JRC agent, JRC marine service department, sales department, regional office, branch or sales office.

Conducting electrical work by anyone other than the specialized maintenance staff may result in an accident or an equipment fault.



Use the screws that are specified in the installation manual when installing this equipment.

Use of any other screws may result in an injury or an equipment failure caused by the equipment dropping down.

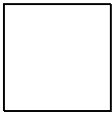

Use the specified power cables, signal cables, and earth cables. Failure to comply may cause faults in some other equipment or cause this equipment to become susceptible to faults from some other equipment.



The distribution processor and the signal processor are to be mounted on a wall only.

Do not mount any way other than wall-mount.

Otherwise, the processors may fail to function.



When mounting the equipment on the wall, mount it firmly to avoid the equipment from dropping under its own weight.

Failure to comply may result in an injury caused by the dropping equipment.



When installing this equipment, make sure that the equipment is connected to the earth terminal and the earth plate properly.

Failure to comply may result in an electric shock at an equipment fault or an electric leakage.



Do not place this equipment inside of a cupboard or cover it with a cardboard.

Failure to comply may cause heat accumulation, resulting in fire or an equipment fault.



Do not use or leave the equipment under direct sunlight for a long time or in the temperatures above 55°C. (except wing display).

Otherwise, fire or a malfunction may occur.



Do not install the equipment in a place under the influence of water, humidity, vapor, dust or soot. (except wing display)

Failure to comply may result in fire, an electric shock, or an equipment malfunction.



Do not place this equipment in a location under the influence of frequent vibrations or impact.

Failure to comply may cause the equipment to drop or fall over, resulting in an injury or an equipment fault.

9.1 Installation of the Main Display and Distribution Processor

Installation location

Install these equipment units in a place that is not susceptible to interferences since signal cables are susceptible to noise and generate noise easily.

Do not install the equipment units parallel to the cable of the DSB radio or amateur radio device.

Do not install the equipment units in a place that is exposed to direct sunlight (except wing displays), wave splashes, or hot air.

9.2 Installation of the Transducer Mounting

CAUTION



It is necessary to choose the place where the bubble is not generated when sailing, and to install the transducer mounting. The transducer mounting is installed in place before 1/10 of the ship's lengths in the large vessel. Moreover, the transducer mounting is installed in place before it when there is bow-thruster.



Coil the excess of the transducer cable after installation at the minimum bending diameter of 400 mm and clamp the cable.



The transducer cable must not be less than 30 m.
Cables less than 30 m in length are not supported.
Cables outside of the range of 30 m to 40 m in length are not guaranteed.

Mounting Location

This equipment measures the ship speed by using the ultrasonic wave.

To cause attenuation and diffusion when the bubble influences the ultrasonic wave, this equipment cannot measure an accurate ship speed.

Mounting Procedure

- After the welding of tank ends, the transducer mounting is installed. If the transducer mounting is built into the tank, after it is detached from the tank, and the tank is welded.
- The tank is welded so that surface of transducer mounting at the sailing may become within 2° for a horizontal plane.
- The tank is installed within 5° so that the bow mark may become parallel to the keel line.

9.3 Connection Diagram

For details of the equipment connection, refer to the Installation Manual.

9.3.1 JLN-740A inter-connection diagram

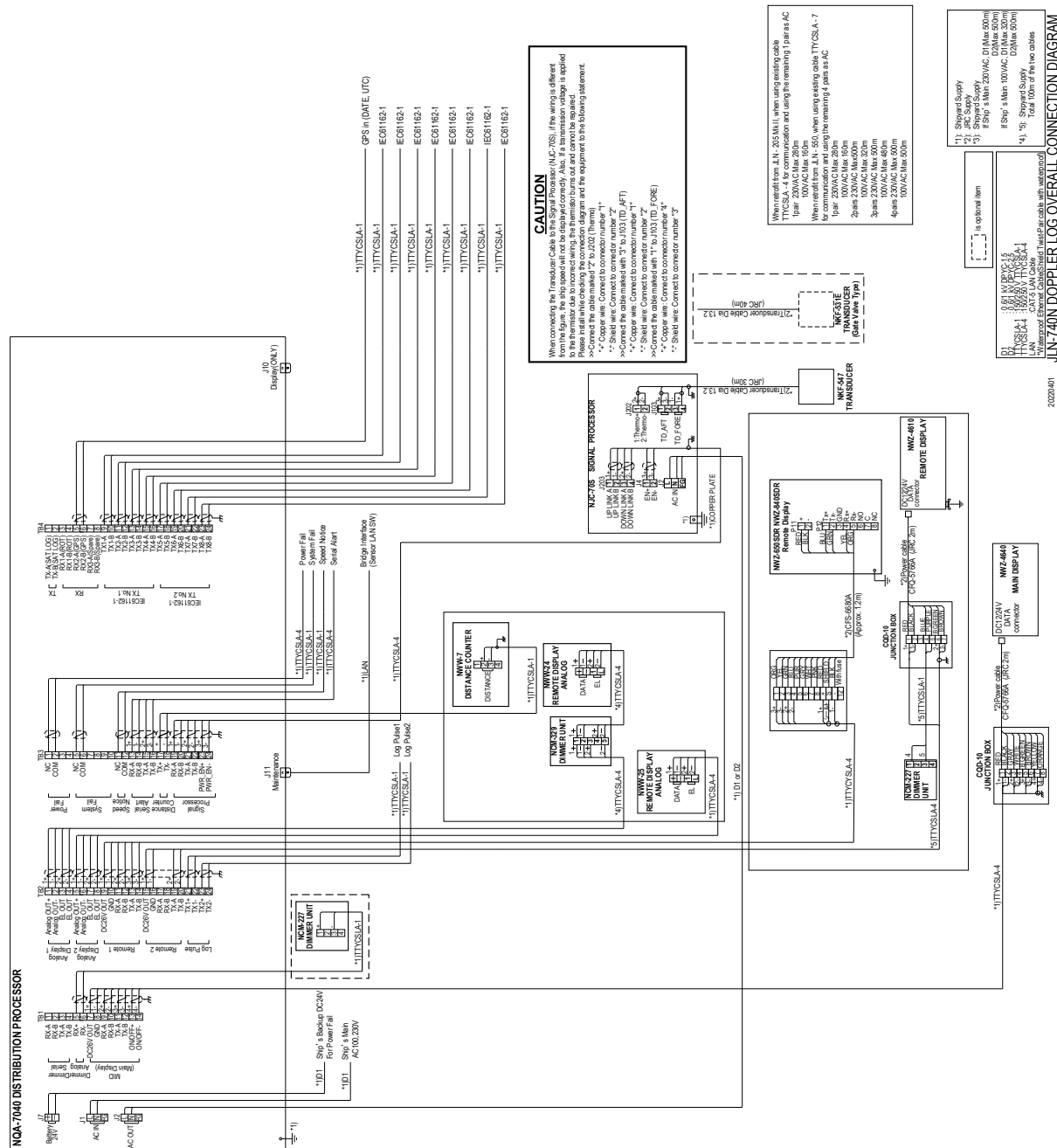

9.3.2 JLN-740N inter-connection diagram

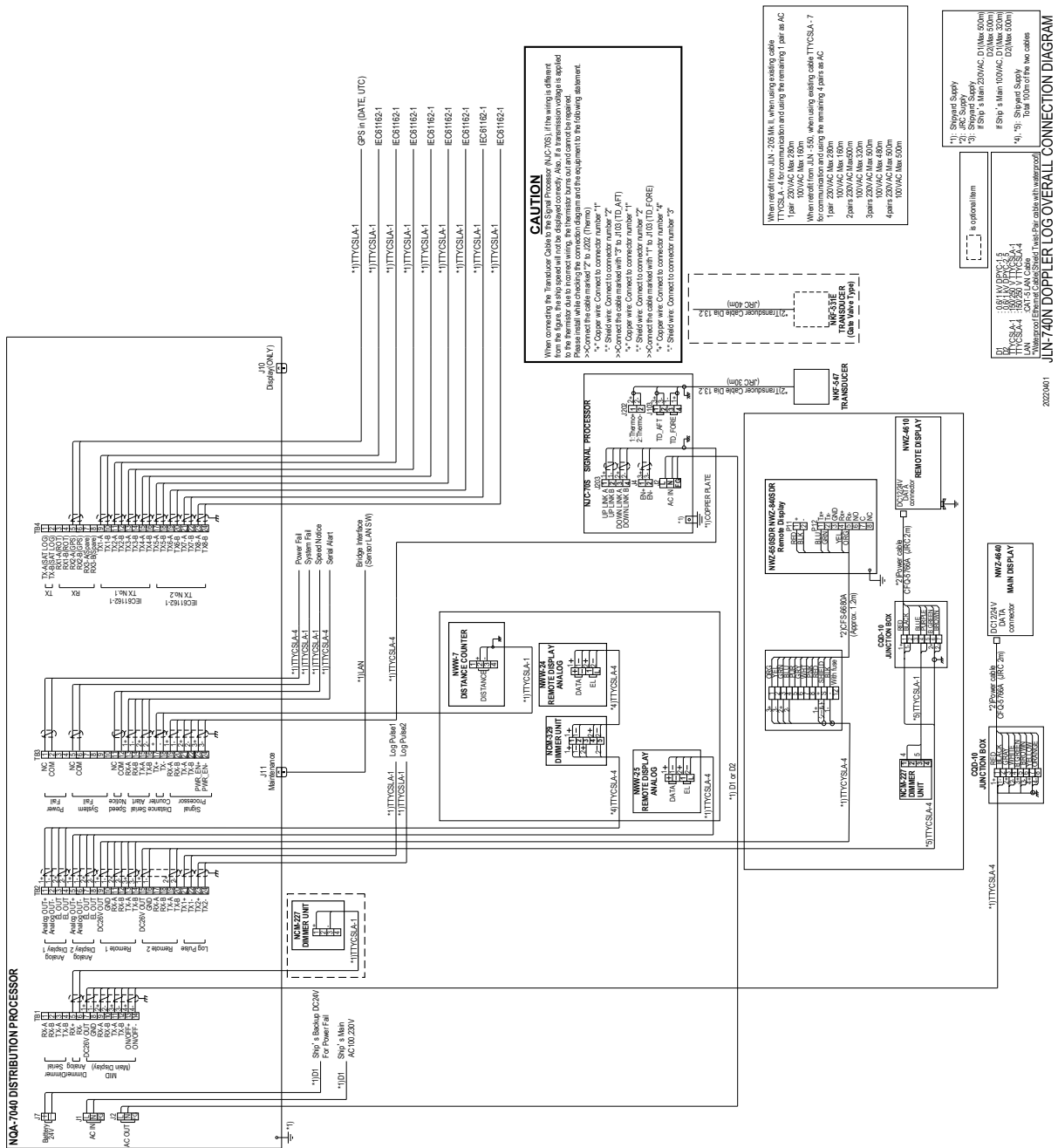

JLN-740N DOPPLER LOG OVERALL CONNECTION DIAGRAM



9.3.3 JLN-741A inter-connection diagram

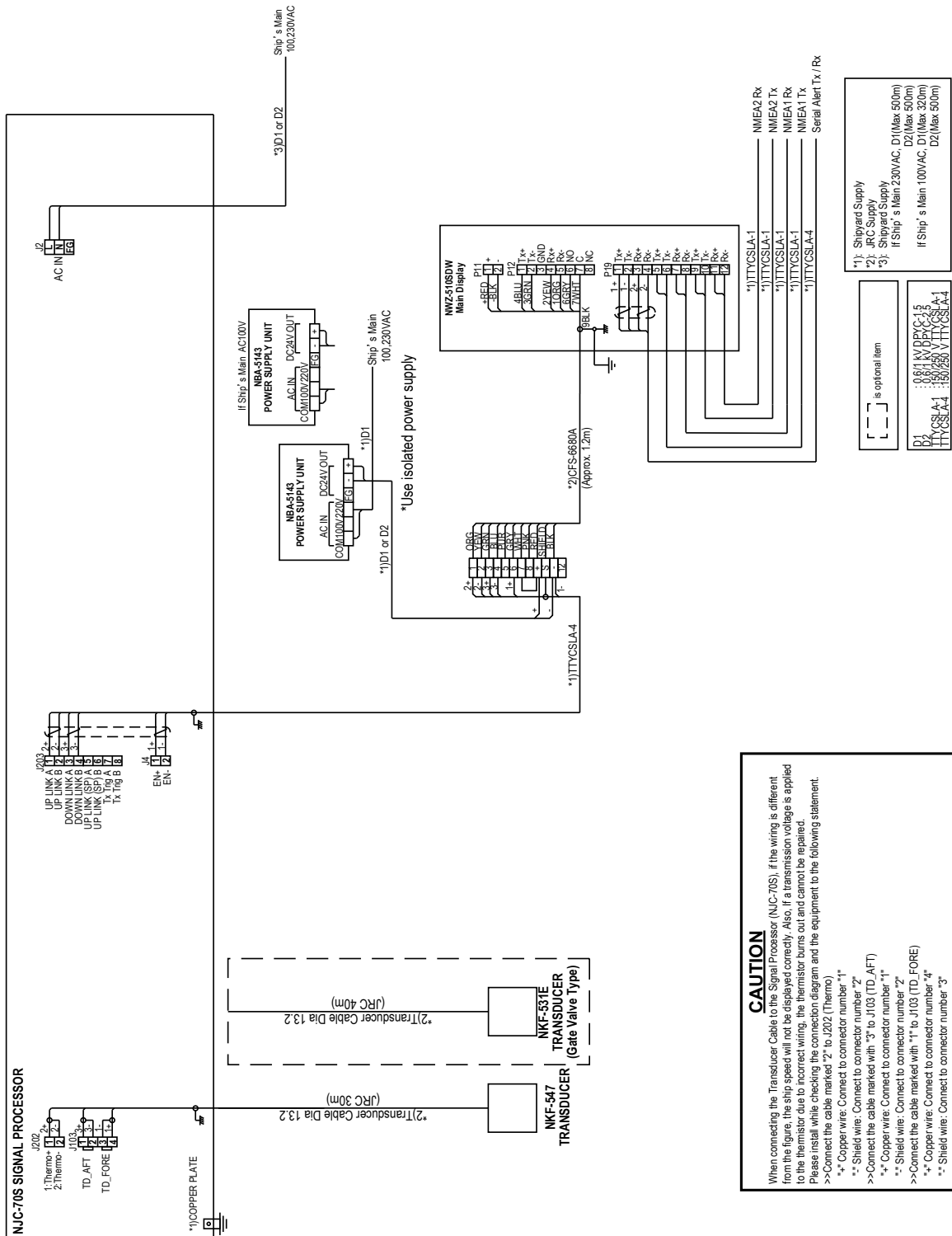

JLN-741A DOPPLER LOG OVERALL CONNECTION DIAGRAM

20220401

9.3.4 JLN-741N inter-connection diagram

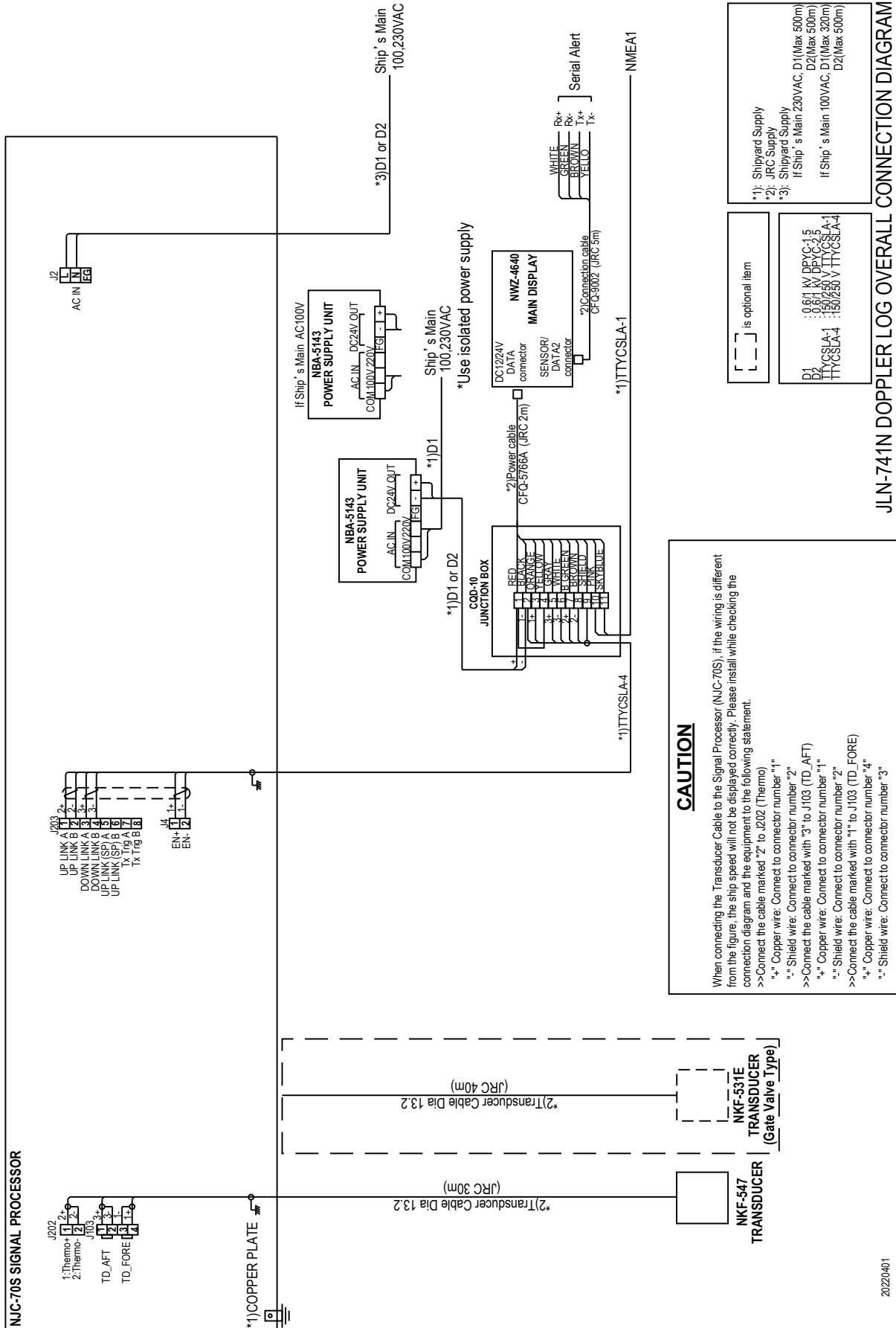

(This page intentionally left blank)

Chapter 10 Maintenance and Inspection

WARNING



Customers shall never attempt to check or repair the inner of the equipment. Inspection or repair by anyone other than the specialized maintenance staff may result in fire or electric shock.



For maintenance, inspection of the internal section of the equipment, request the store, nearest JRC agent, JRC marine service department, sales department, regional office, branch or sales office.



In case you find smoke, unusual odor or extreme high heat coming from the equipment, turn off the power immediately, unplug the power supply cable from an electric outlet, and contact the store, nearest JRC agent, JRC marine service department, sales department, regional office, branch or sales office. Keeping the equipment in operation under such condition may cause fire or an electric shock.

10.1 Routine Maintenance

10

The life of equipment is determined by the degree of routine maintenance and inspection conditions. To constantly maintain the equipment in good condition, it is recommended to carry out regular inspection. This prevents equipment faults.

Regularly carry out the inspections that are listed in the table.

CAUTION

- Before inspecting the equipment, make sure that the power supply and the breaker are turned off.
- Do not use any organic solvent such as thinner or benzene to clean the surface of the equipment. Failure to comply damages the surface coating. Clean the surface by removing any rubbish and dust and wipe the surface with a clean cloth.

Maintenance and inspection method

Item	Maintenance inspection
Cleaning	Remove any stains from the panel surface, knobs, switches, top cover, and bottom cover by gently wiping with a dry cloth. Clean thoroughly the blades of the air vent to improve the air flow. To clean the display, use a solution of mild soap and water, if needed.
Loose parts	Check for any loose screws, nuts, knobs, switches, and connectors and correctly tighten any loose parts.
Cable connection	Check the connections of equipment cables and connectors to ensure that they are connected properly.
Fuse	When the power supply fuse is blown, replace the fuse after thoroughly checking the cause.

10.2 Countermeasures for Abnormalities and Faults

When any of the following symptoms is detected, contact the store, nearest JRC agent, JRC marine service department, sales department, regional office, branch or sales office.

- The screen is blank or the power is not supplied to the equipment even if the power supply button is pressed.
- Smoke, abnormal odor, or abnormal high temperature is detected.

In this case, turn off the power supply and breaker immediately.

The contact method can be found in back spine cover of this manual.

10.3 Repair unit

Repair units and their models are shown below.

Model Name	No.	Name	Model	Remarks
NQA-7040	1	Terminal board	CQD7040	
	2	Power supply unit	UZP-150-24-J0E3-K	
NJC-70S	1	Processor circuit	CDC7400	
	2	TX/RX circuit	CMN7400	
	3	I/F circuit	CDF7400	
	4	Power circuit	CBD7400	
	5	Power supply unit	UZP-150-48-J0E	

10.4 Troubleshooting

Fault symptom	JLN-740A	JLN-740N	JLN-741A	JLN-741N	Assumed cause	Countermeasure
The power supply is not turned on even if the power switch is pressed.	○	○	○	○	Power is not supplied from the on-board distribution board.	Check if the wiring from the distribution board is normal. Check that the distribution board circuit breaker is ON.
	○	○	○	○	The fuse that is connected to the power cable has been blown.	After checking that the wiring is normal, replace the fuse.
	○	○	○	○	The display switch is faulty.	Contact JRC Sales Department, or your nearest branch, sales office, or our distributor.
No screen is displayed on the LCD unit.	○	○	○	○	The screen brightness of the LCD unit is set too low.	Adjust the brightness. (Refer to 3.1.2, 5.1.2, and 7.1.1.)
	○	○	○	○	The LCD unit is faulty.	Contact JRC Sales Department, or your nearest branch, sales office, or our distributor.
Ship speed is not displayed.	○	○	○	○	The model setting is incorrect.	Contact JRC Sales Department, or your nearest branch, sales office, or our distributor.
The sensitivity of the touch panel is low.	○		○		The touch position is shifted.	Modify the touch position. (Refer to 4.1.3.1.)
	○		○		The LCD unit is faulty.	Contact JRC Sales Department, or your nearest branch, sales office, or our distributor.
Missing data	○	○	○	○	The water depth is too low.	Since a ship speed cannot be measured when the water depth is lower than 3 m, check the water depth.
The ship speed that is displayed is obviously slow.	○	○	○	○	The ship speed correction setting is incorrect.	Contact JRC Sales Department, or your nearest branch, sales office, or our distributor.
Alert "LOST SPEED" is displayed.	○	○	○	○	Disconnected with the signal processor.	Contact JRC Sales Department, or your nearest branch, sales office, or our distributor.

Fault symptom	JLN-740A	JLN-740N	JLN-741A	JLN-741N	Assumed cause	Countermeasure
There is a large difference with the ship speed relative to land meter.	<input type="radio"/>	<input type="radio"/>	<input type="radio"/>	<input type="radio"/>	Impact from the tidal current and wind	Check if there is any impact of tidal current and wind by using a current meter and an anemometer.
	<input type="radio"/>	<input type="radio"/>	<input type="radio"/>	<input type="radio"/>	The ship speed correction setting is incorrect.	Contact JRC Sales Department, or your nearest branch, sales office, or our distributor.
	<input type="radio"/>	<input type="radio"/>	<input type="radio"/>	<input type="radio"/>	"UNIT" is set to m/s ⇔ kn unintentionally.	Check the "UNIT" setting. (Refer to 4.1.3.7, 5.2.1, and 8.1.2.7.)
The power supply cannot be turned off.	<input type="radio"/>				Main display NWZ-510SDW and distribution processor NQA-7040 cannot communicate correctly.	Turn off the power supply of the distribution processing by pressing switch "S1" and check the communication between the main display and the distribution processor.
The date and time that are displayed on alert are incorrect.	<input type="radio"/>	<input type="radio"/>	<input type="radio"/>		The data is not corrected from the input from the GPS sensor.	Check the communication line with the GPS sensor.
	<input type="radio"/>	<input type="radio"/>			The power supply is left in the Off state for one week or longer.	Since the CQD-7040 super capacitor has discharged, reset it manually. When the power supply is turned on again, charging starts.
	<input type="radio"/>		<input type="radio"/>		The power supply is left in the Off state for one week or longer.	Since the NWZ-510SDW super capacitor has discharged, reset it manually. When the power supply is turned on again, charging starts.
Although an alert is displayed in the alert list, the alert icon remains in the normal state.	<input type="radio"/>		<input type="radio"/>		The NWZ-510SDW alert is set to OFF.	Contact JRC Sales Department, or your nearest branch, sales office, or our distributor.
The ship speed that is displayed by the analog display seems to be incorrect.	<input type="radio"/>	<input type="radio"/>			The analog full scale setting is incorrect.	Contact JRC Sales Department, or your nearest branch, sales office, or our distributor.

Fault symptom	JLN-740A	JLN-740N	JLN-741A	JLN-741N	Assumed cause	Countermeasure
The ship speed changes significantly or cannot be measured, or missing data occurs during sailing.	○	○	○	○	Influence of the bubbles accumulated around the transducer radiation face. Bubble entrainment due to sailing over the trail of another ship.	When the function is not recovered during sailing, contact JRC Sales Department, or your nearest branch, sales office, or our distributor.
	○	○	○	○	Influence of the bubbles accumulated around the transducer radiation face. The bubbles produced at pier docking are accumulated at the bottom of the ship	When the function is not recovered after leaving the port, contact JRC Sales Department, or your nearest branch, sales office, or our distributor.

10.5 Maintenance information

Fault symptom	JLN-740A	JLN-740N	JLN-741A	JLN-741N	Assumed cause	Countermeasure
"OVER SPEED STW", is displayed.	○	○			Ship speed through water exceeded the speed limit setting range.	Check the speed limit setting. (Refer to 4.1.3.8 and 6.1.3.4.)
"BUBBLE DETECTED" is displayed.	○	○			The bubble detected on the surface of the transducer.	Check the bubble detect setting. (Refer to 4.1.3.9.2 and 6.9)
"MAINTENACE MODE" is displayed.	○	○			Maintenance mode is running.	Please wait until the maintenance is completed.
"HW ERROR. NWZ-510" is displayed.	○				NWZ-510SDW is faulty.	Contact JRC Sales Department, or your nearest branch, sales office, or our distributor.
"HW ERR. NWZ-4640" is displayed.		○			NWZ-4640 is faulty.	Contact JRC Sales Department, or your nearest branch, sales office, or our distributor.
"HW ERROR .NQA-7040" is displayed.	○	○			CQD-7040 in NQA-7040 is faulty.	Contact JRC Sales Department, or your nearest branch, sales office, or our distributor.
"HW ERROR . NJC-70." is displayed.	○	○			CDF-7400 in NJC-70 is faulty.	Contact JRC Sales Department, or your nearest branch, sales office, or our distributor.
"NO BUBBLE REFERENCE" is displayed.	○	○			Bubble detection reference data is not set.	Contact JRC Sales Department, or your nearest branch, sales office, or our distributor.
"TX/RX STOP" is displayed.	○	○			Transmission power error in NJC-70	Contact JRC Sales Department, or your nearest branch, sales office, or our distributor.
"PA STOP" is displayed.	○	○			CMN-7400 in NJC-70 is faulty.	Contact JRC Sales Department, or your nearest branch, sales office, or our distributor.
"CPU STOP .CDC-7400" is displayed.	○	○			CDC-7400 in NJC-70 is faulty.	Contact JRC Sales Department, or your nearest branch, sales office, or our distributor.

Fault symptom	JLN-740A	JLN-740N	JLN-741A	JLN-741N	Assumed cause	Countermeasure
“HW ERROR .CDC-7400” is displayed.	○	○			CDC-7400 in NJC-70 is faulty.	Contact JRC Sales Department, or your nearest branch, sales office, or our distributor.
“ROT DATA RECV FAIL” is displayed.	○	○			The distribution processor is not receiving the ROT sentence.	Contact JRC Sales Department, or your nearest branch, sales office, or our distributor.
“PLEASE SET DATE-TIME” is displayed.	○	○			The date-time is not setting.	Please set date-time. (Refer to 4.1.3.4 and 6.6)
“DISPLAY COMM. FAIL” is displayed.	○	○			Display is faulty.	Contact JRC Sales Department, or your nearest branch, sales office, or our distributor.
“SENSOR COMM. FAIL” is displayed.	○	○			NJC-70 is faulty.	Contact JRC Sales Department, or your nearest branch, sales office, or our distributor.
“CPU1 MISMATCH .1MIN REMAINS.” is displayed.	○	○			The software version of CDC-7400 in NJC-70 does not match.	Contact JRC Sales Department, or your nearest branch, sales office, or our distributor.
“CPU2 MISMATCH .1MIN REMAINS.” is displayed.	○	○			The software version of CDC-7400 in NJC-70 does not match.	Contact JRC Sales Department, or your nearest branch, sales office, or our distributor.
“CPU3 MISMATCH .1MIN REMAINS.” is displayed.	○	○			The software version of CDC-7400 in NJC-70 does not match.	Contact JRC Sales Department, or your nearest branch, sales office, or our distributor.
“CPU4 MISMATCH .1MIN REMAINS.” is displayed.	○	○			The software version of CDC-7400 in NJC-70 does not match.	Contact JRC Sales Department, or your nearest branch, sales office, or our distributor.
“FPGA1 MISMATCH .10MIN REMAINS.” is displayed.	○	○			The software version of CDC-7400 in NJC-70 does not match.	Contact JRC Sales Department, or your nearest branch, sales office, or our distributor.
“FPGA2 MISMATCH .10MIN REMAINS.” is displayed.	○	○			The software version of CDC-7400 in NJC-70 does not match.	Contact JRC Sales Department, or your nearest branch, sales office, or our distributor.

Fault symptom	JLN-740A	JLN-740N	JLN-741A	JLN-741N	Assumed cause	Countermeasure
"PARSING OF NMEA FAILED" is displayed.	<input type="radio"/>	<input type="radio"/>			The display has detected a communication error.	Contact JRC Sales Department, or your nearest branch, sales office, or our distributor.
"INVALID CHECHSUM OF NMEA" is displayed.	<input type="radio"/>				The display has detected a communication error.	Contact JRC Sales Department, or your nearest branch, sales office, or our distributor.
"VBW TIME OUT" is displayed.	<input type="radio"/>	<input type="radio"/>			The display has detected a communication error.	Contact JRC Sales Department, or your nearest branch, sales office, or our distributor.
"VLW TIME OUT" is displayed.	<input type="radio"/>	<input type="radio"/>			The display has detected a communication error.	Contact JRC Sales Department, or your nearest branch, sales office, or our distributor.
"DISTRIBUTOR COM. FAIL" is displayed.	<input type="radio"/>				The display has detected a communication error.	Contact JRC Sales Department, or your nearest branch, sales office, or our distributor.
"MODBUS TIME OUT" is displayed.	<input type="radio"/>				The display has detected a communication error.	Contact JRC Sales Department, or your nearest branch, sales office, or our distributor.
"MODBUS CANNOT CONNECT TO DP" is displayed.	<input type="radio"/>				The display has detected a communication error.	Contact JRC Sales Department, or your nearest branch, sales office, or our distributor.
"UPDATE MODE" is displayed.	<input type="radio"/>				Software update is running.	Please wait until the maintenance is completed.

Chapter 11 After-Sales Service

11.1 Requesting Repair

When suspecting “fault”, stop using the equipment and contact the store, nearest JRC agent, JRC marine service department, sales department, regional office, branch or sales office.

● Repair under the warranty period

When the equipment becomes faulty while it is used in the normal utilization condition according to the description/instruction in the instruction manual, the distributor or JRC will repair the equipment without charge. If the equipment becomes faulty due to mishandling, negligence, or for a reason beyond control such as natural disaster or fire, repair is charged.

● Repair beyond the warranty period

When the functions can be recovered by repair, JRC will repair the equipment with charge according to the customer’s request.

● Necessary information

- Product name, model name, manufacturing date, and manufacturing number
- Condition of abnormality (as detailed as possible)
- Office name or organization name, address, telephone number and FAX number

11.2 Recommendation of Inspection and Maintenance

The performance may deteriorate due to the aging of parts although the degree varies depending on the utilization condition. For the inspection and maintenance separate from the normal maintenance, contact the store, nearest JRC agent, JRC marine service department, sales department, regional office, branch or sales office.

This service is charged.

For any questions regarding the after-sales service, please contact your distributor/agent, JRC branch, sales office, or liaison office. The contact method can be found in back spine cover of this manual.

Chapter 12 Disposal

WARNING



Disposal treatment of this equipment must comply with the rules and regulations of the Government or the local government.

Disposal of this equipment

Disposal treatment of this equipment must comply with the regulations or rules of the Government or the local government that controls the location of the disposal.

(This page intentionally left blank)

Chapter 13 Specification

13.1. General Specification

13.1.1. JLN-740A

Water speed measuring system	Dual – beam pulse Doppler system
Operation frequency	2 MHz
Fore/after speed measurement scale	-10.00 to +40.00 kn
No. of digits displayed	Fixed 4 or 3 digits selectable
Minimum digital display unit	0.01 kn or 0.1 kn selectable
Sailing display range	0 to 999999.99NM (0 to 9999.99NM for optional NWW-7 0 to 99999.99NM for optional NWZ-4610)
Water speed measurable depth	3.0 m deeper than the transducer surface
Ship speed accuracy	1% of the speed of the ship, or 0.1 kn whichever is greater
Total distance accuracy	1% of the distance run by the ship in 1h or 0.1 nautical miles in each hour whichever is greater
Power consumption	50 W 60VA (for 100VAC) 50 W 150VA (for 230VAC)
Power consumption of resource alert circuit	0.25 W (normal condition) 0.5 W (when power fail alert happening)

13.1.2. JLN-740N

Water speed measuring system	Dual – beam pulse Doppler system
Operation frequency	2 MHz
Fore/after speed measurement scale	-10.00 to +40.00 kn
No. of digits displayed	Fixed 4 or 3 digits selectable
Minimum digital display unit	0.01 kn or 0.1 kn selectable
Minimum analog display unit	Scale: 0.5 kn units Value: 5.0 kn units
Sailing display range	0 to 99999.99NM (0 to 9999.99NM for optional NWW-7 0 to 99999.99NM for optional NWZ-4610)
Water speed measurable depth	3.0 m deeper than the transducer surface
Ship speed accuracy	1% of the speed of the ship, or 0.1 kn whichever is greater
Total distance accuracy	1% of the distance run by the ship in 1h or 0.1 nautical miles in each hour whichever is greater
Power consumption	40 W 55VA (for 100VAC) 45 W 145VA (for 230VAC)
Power consumption of resource alert circuit	0.25 W (normal condition) 0.5 W (when power fail alert happening)

13.1.3. JLN-741A

Water speed measuring system	Dual – beam pulse Doppler system
Operation frequency	2 MHz
Fore/after speed measurement scale	-10.00 to +40.00 kn
No. of digits displayed	Fixed 4 or 3 digits selectable
Minimum digital display unit	0.01 kn or 0.1 kn selectable
Sailing display range	0 to 999999.99NM
Water speed measurable depth	3.0 m deeper than the transducer surface
Ship speed accuracy	1 % of the speed of the ship, or 0.1 kn whichever is greater
Total distance accuracy	1% of the distance run by the ship in 1h or 0.1 nautical miles in each hour whichever is greater
Power consumption	20 W 30VA (for 100VAC) 20 W 75VA (for 230VAC)

13.1.4. JLN-741N

Water speed measuring system	Dual – beam pulse Doppler system
Operation frequency	2 MHz
Fore/after speed measurement scale	-10.00 to +40.00 kn
No. of digits displayed	Fixed 4 or 3 digits selectable
Minimum digital display unit	0.01 kn or 0.1 kn selectable
Minimum analog display unit	Scale: 0.5 kn units Value: 5.0 kn units
Sailing display range	0 to 99999.99NM
Water speed measurable depth	3.0 m deeper than the transducer surface
Ship speed accuracy	1 % of the speed of the ship, or 0.1 kn whichever is greater
Total distance accuracy	1% of the distance run by the ship in 1h or 0.1 nautical miles in each hour whichever is greater
Power consumption	20 W 25VA (for 100VAC) 20 W 75VA (for 230VAC)

13.2. JLN-740A/741A Main Display NWZ-510SDW

⚠ CAUTION JLN-741A/741N does not use NWZ-510SDW

13.2.1. Display Unit

Display unit	5-inch color LCD, 480(H) × 800(V) pixels (WVGA)
Pixel pitch	0.135 mm
Operation buttons	Touch panel and power supply button
Backlight (LED)	LCD and power supply button
Maximum luminance	300 cd/m ² or more (when maximum luminance is set)
Viewing distance	1 m
Minimum character visually distance	30 cm
Fore/after speed visually distance	4.6 m
Dimmer function adjustments	Selection from daytime(DAY), intermediate(DUSK), nighttime(NIGHT) and 17-level

13.2.2. Electrical Specifications

Power supply voltage	24VDC (18V to 34V)
Power consumption	About 8 W

13.2.3. Environmental Requirements

Operating temperature range	-15°C to +55°C (IEC 60945 ed.4 Protected equipment)
Storage temperature range	-20°C to +70°C
Protection level	Equivalent to IP22 (front at installation of flush-mount)
Vibration	Complies with IEC 60945 ed.4
EMC	Complies with IEC 60945 ed.4
Compass safety distance	0.1 m (STD), 0.1 m (STEER)

13.2.4. Mechanical Specifications

External size	96 mm (width) × 180 mm (height) × 80 mm (depth), protrusions excluded
Mass	1.2 kg
Color	Munsell N2.5
Mounting	Desktop or flush-mount

13.2.5. External Interface

[JLN-741A configuration]

IEC 61162-1

Output: 2ch

IEC 62923-1 / -2

Input / Output: 1ch

13.3. JLN-740N/741N Main Display NWZ-4640

⚠ CAUTION JLN-741A/741N does not use NWZ-4640

13.3.1. Display Unit

Display unit	4.5 inch monochrome LCD 128 × 64 dots
Pixel pitch	0.74 mm
Backlight	White LED or orange LED (selectable)
Dimmer Levels	4 levels (Bright, Medium, Dark, OFF)
Dimmer control	Key or external dimmer unit
Contrast	13 levels
Key	12 keys Operation buttons
Viewing distance	1 m
Fore/after speed visual distance	8.0 m

13.3.2. Electrical Specifications

Power supply voltage	12/24VDC (10.8V to 31.2V)
Power consumption	Less than 2.5 W
Memory backup	Flash memory

13.3.3. Environmental Requirements

Operating temperature range	-15°C to +55°C (IEC 60945 ed.4 Protected equipment)
Storage temperature range	-20°C to +70°C
Protection level	Equivalent to IP55
Vibration	Complies with IEC 60945 ed.4
EMC	Complies with IEC 60945 ed.4
Compass safety distance	1.00 m (STD), 0.5 m (STEER)

13.3.4. Mechanical Specifications

External size	142(W) × 142(H) × 92(D) mm (without Base unit) 175(W) × 162(H) × 92(D) mm (Include Base unit)
Mass	0.8 kg
Body Color	Munsell N2.5
Installation	Desktop or flush-mount

13.3.5. External interface

[JLN-741N configuration]

IEC 61162-1	Output: 1ch
IEC 62923-1	Input / Output 1ch

13.4. Distribution Processor NQA-7040

⚠ CAUTION JLN-741A/741N does not use NQA-7040

13.4.1. Electrical Specifications

Power supply voltage	100/230VAC (90V to 253V)
Power consumption	Maximum 30 W (include sensor and displays power)

13.4.2. Environmental Requirements

Operating temperature range	-15°C to +55°C (IEC 60945 ed.4 Protected equipment)
Storage temperature range	-20°C to +70°C
Protection level	IP22
Vibration	Complies with IEC 60945 ed.4
EMC	Complies with IEC 60945 ed.4
Compass safety distance	0.8 m (STD), 0.4 m (STEER)

13.4.3. Mechanical Specifications

External size	300 mm (width) × 490 mm (height) × 130 mm (depth), protrusions excluded
Mass	About 6 kg
Color	Munsell N2.5

13.4.4. External Interface

IEC 61162-1	Input: 1ch (RMC/ZDA) Output: 8ch (VBW/VLW) For the details, refer to 13.11.
Alert	Serial alert output
Fail	Power supply Fail / System fail / Speed notice
Distance counter pulse output	1ch
Log pulse output	2ch
Remote display unit	1 system 2ch
Analog display unit	1 system 2ch
Analog dimmer input	1ch
Serial dimmer input/output	1ch
IEC 61162-450	For the details, refer to 13.11.2.
IEC 62923-1 / -2	Input / Output 1ch

13.5. Signal Processor NJC-70S

13.5.1. Electrical Specifications

Power supply voltage	100/230VAC (90V to 253V)
Power consumption	Maximum of 19 W

13.5.2. Environmental Requirements

Operating temperature range	-15°C to +55°C (IEC 60945 ed.4 Protected equipment)
Storage temperature range	-20°C to +70°C
Protection level	IP55
Vibration	Complies with IEC 60945 ed.4
EMC	Complies with IEC 60945 ed.4
Compass safety distance	0.2 m (STD), 0.1 m (STEER)

13.5.3. Mechanical Specifications

External size	315 mm (width) × 422 mm (height) × 197 mm (depth), protrusions excluded
Mass	About 5.5 kg
Color	Munsell N2.5

13.6. Transducer mounting NKF-547

13.6.1. Electrical Specifications

Operation frequency	2 MHz
Oscillator	CFT-022C

13.6.2. Environmental Requirements

Operating temperature range	-3°C to +40°C
Storage temperature range	-10°C to +70°C
Transducer mounting water pressure resistance	600 kPa (6 bar) for 12 h

13.6.3. Mechanical Specifications

External size	$\phi 135 \times 130$ mm
Mass	17.0 kg
Cable	30 m

13.7. Transducer mounting (Option)

NKF-531E

13.7.1. Electrical Specifications

Operation frequency	2 MHz
Oscillator	CFT-023C

13.7.2. Environmental Requirements

Operating temperature range	-3°C to +40°C
Storage temperature range	-10°C to +70°C
Transducer mounting water pressure resistance	600 kPa (6 bar) for 12 h

13.7.3. Mechanical Specifications

External size	467.5 × 175 × 390 mm
Mass	48.0 kg
Cable	40 m

13.8. Remote Display (Optional)

NWZ-650SDR

⚠ CAUTION JLN-741A/741N does not use NWZ-650SDR

13.8.1. Display Unit

Display unit	6.5-inch color LCD, 480(H) × 640(V) pixels (VGA)
Pixel pitch	0.207 mm
Operation buttons	Touch panel and power supply button
Backlight (LED)	LCD and power supply button
Maximum luminance	300 cd/m ² or more (Default brightness value is 'Maximum Dim+ level')
Viewing distance	1.2 m
Fore/after speed visual distance	5.7 m
Dimmer function adjustments	Selection from daytime, intermediate, nighttime and 17-level

13.8.2. Electrical Specifications

Power supply voltage	24VDC (18V to 34V)
Power consumption	About 10 W

13.8.3. Environmental Requirements

Operating temperature range	-15°C to +55°C (IEC 60945 ed.4 Protected equipment)
Storage temperature range	-20°C to +70°C
Protection level	Equivalent to IP22 (front at installation of flush-mount)
Vibration	Complies with IEC 60945 ed.4
EMC	Complies with IEC 60945 ed.4
Compass safety distance	0.1 m (STD), 0.1 m (STEER)

13.8.4. Mechanical Specifications

External size	160 mm (width) × 180 mm (height) × 80 mm (depth), protrusions excluded
Mass	1.4 kg
Color	Munsell N2.5

13.9. Remote Display (Optional)

NWZ-840SDR

⚠ CAUTION JLN-741A/741N does not use NWZ-840SDR

13.9.1. Display Unit

Display unit	8.4-inch color LCD, 800(H) × 600(V) pixels (SVGA)
Pixel pitch	0.213 mm
Operation buttons	Touch panel and power supply button
Backlight (LED)	LCD and power supply button
Maximum luminance	300 cd/m ² or more (Default brightness value is 'Maximum Dim+ level')
Viewing distance	1.2 m
Fore/after speed visual distance	5.7 m
Dimmer function adjustments	Selection from daytime, intermediate, nighttime and 17-level

13.9.2. Electrical Specifications

Power supply voltage	24VDC (18V to 34V)
Power consumption	About 11 W

13.9.3. Environmental Requirements

Operating temperature range	-15°C to +55°C (IEC 60945 ed.4 Protected equipment)
Storage temperature range	-20°C to +70°C
Protection level	Equivalent to IP22 (front at installation of flush-mount)
Vibration	Complies with IEC 60945 ed.4
EMC	Complies with IEC 60945 ed.4
Compass safety distance	0.1 m (STD), 0.1 m (STEER)

13.9.4. Mechanical Specifications

External size	240 mm (width) × 180 mm (height) × 80 mm (depth), protrusions excluded
Mass	2.1 kg
Color	Munsell N2.5

13.10. MID (Optional) NWZ-4610

⚠ CAUTION JLN-741A/741N does not use NWZ-4610

13.10.1. Display Unit

Display unit	4.5-inch black-and-white LCD, 128 × 64 pixels
Pixel pitch	0.74 mm
Backlight	White LED or Orange LED (switched by setting)
Dimmer function adjustments	4-level (bright, intermediate, dark, off)
Dimmer control	Button or dimmer unit
Contrast	13-level
Operation buttons	12 buttons
Memory backup	Flash memory

13.10.2. Electrical Specifications

Power supply voltage	12/24VDC (10.8V to 31.2V)
Power consumption	Below 2.5 W

13.10.3. Environmental Requirements

Operating temperature range	-15°C to +55°C (IEC 60945 ed.4 Protected equipment)
Storage temperature range	-20°C to +70°C
Vibration	Complies with IEC 60945 ed.4
EMC	Complies with IEC 60945 ed.4
Protection level	Equivalent to IP55

13.10.4. Mechanical Specifications

External size	142 mm (width) × 142 mm (height) × 92 mm (depth) without desk rack 175 mm (width) × 162 mm (height) × 92 mm (depth) with desk rack
Mass	0.8 kg
Rack color	Munsell N4/N2.5
Installation	Desktop or flush-mount

13.11. JLN-740A/N Data Format

13.11.1. IEC 61162-1 Input/Output Data

13.11.1.1. Output data

Protocol

IEC 61162-1(NMEA0183)

Baud rate : 4800

Data bit : 8 bits

Parity : none

Start bit : 1

Stop bit : 1

interval : 1 sec

version : NMEA0183 ver1.5, 2.1, 2.3, 4.0, **IEC 61162-1**

version is selected by installation setting menu. Default value
IEC 61162-1.

Data Sentences

 **CAUTION** The length of each sentence is variable. Make sure that sentences of any length can be received.

IEC 61162-1 No.1 4 ports

IEC 61162-1 No.2 4 ports

VBW : Dual ground/water speed (JLN-740/741 outputs speed over water only)

VLW : Dual ground/water distance (JLN-740/741 outputs distance over water only)

Serial Alert 1 port

ALF : Alert sentence

ALC: Cyclic alert list

ARC: Alert command refused

HBT : Monitoring communication enabled/disabled

Dimmer Serial 1 port

DDC : Display dimming control

Output data format

■ VBW – Dual ground/water speed

Version 1.5

\$VDVBW, uxx.xx,uxx.xx,A,uxx.xx,uxx.xx,A<CR><LF>
1 2 3 4 5 6

Version 2.1

\$VDVBW, x.x,x.x,A,x.x,x.x,A*hh<CR><LF>
1 2 3 4 5 6 11

Version 2.3, 4.0, IEC 61162-1

\$VDVBW, x.x,x.x,A,x.x,x.x,A,x.x,A*hh<CR><LF>
1 2 3 4 5 6 7 8 9 10 11

1	:	Fore/after speed over water, knots	“-“ = astern
2	:	Transverse speed over water, knots	“-“ = port
3	:	Status: speed over water,	A = data valid, V = data invalid
4	:	Fore/after speed over the ground, knots	“-“ = astern
5	:	Transverse speed over the ground, knots	“-“ = port
6	:	Status: speed over the ground,	A = data valid, V = data invalid
7	:	Stern starboard/port speed over water, knots	“-“ = port
8	:	Status: stern speed over water,	A = data valid, V = data invalid
9	:	Stern starboard/port speed over the ground,	“-“ = port
10	:	Status: stern speed over the ground,	A = data valid, V = data invalid
11	:	Checksum	

■ VLW – Dual ground/water distance

Version 1.5

\$VDVLW, xxxx.x,N,xxx.xx,N<CR><LF>
1 2

Version 2.1, 2.3

\$VDVLW, x.x,N,x.x,N*hh<CR><LF>
1 2 3

1	:	Total distance, nautical miles
2	:	Trip distance, nautical miles
3	:	Checksum

Version 4.0, IEC 61162-1

\$VDVLW, x.x,N,x.x,N,x.x,N,x.x,N*hh<CR><LF>
1 2 3 4 5

1	:	Total water distance, nautical miles
2	:	Trip distance over water, nautical miles
3	:	Total distance over the ground, nautical miles
4	:	Trip distance over the ground, nautical miles
5	:	Checksum

■ **ALF – Alert sentence**

\$VDALF,x,x,x,hhmmss.ss,a,a,a,aaa,x.x,x.x,x.x,x,c---c*hh <CR><LF>

1 2 3 4 5 6 7 8 9 10 11 12 13 14

- 1 : Total number of ALF sentences for this message, 1 to 2
- 2 : Sentence number, 1 to 2
- 3 : Sequential message identifier, 0 to 9
- 4 : Time of last change
- 5 : Alert category, A, B or C
- 6 : Alert priority, E, A, W or C
- 7 : Alert state, A, S, N, O, U or V
- 8 : Manufacturer mnemonic code
- 9 : Alert identifier
- 10 : Alert instance, 1 to 999999
- 11 : Revision counter, 1 to 99
- 12 : Escalation counter, 0 to 9
- 13 : Alert text
- 14 : Checksum

■ **ALC – Cyclic alert list**

\$VDALC,xx,xx,xx,x.x,aaa,x.x,x.x,x.x,.....,aaa,x.x,x.x,x.x*hh <CR><LF>

1 2 3 4 5 6 7 8 5 6 7 8 9

- 1 : Total number of sentences for this message, 01 to 99
- 2 : Sentence number, 01 to 99
- 3 : Sequential message identifier, 00 to 99
- 4 : Number of alert entries
- 5 : Manufacturer mnemonic code
- 6 : Alert identifier
- 7 : Alert instance
- 8 : Revision counter
- 9 : Checksum

■ ARC – Alert command refused

\$ VDARC, hhmss.ss, aaa, x.x, x.x, c*hh<CR><LF>

1 2 3 4 5 6

- 1 : Release time
- 2 : Alert specifically defined by the manufacturer
- 3 : Alert ID
- 4 : Alert instance
- 5 : Rejected alert command
- 6 : Checksum

■ HBT – Monitoring communication enabled/disabled

\$ VDHBT, x.x, A, x*hh<CR><LF>

1 2 3 4

- 1 : Repetition cycle setting
- 2 : Equipment status
- 3 : Sequence number
- 4 : Checksum

■ DDC – Display dimming control

\$ VDDDC, a, xx, a, a*hh<CR><LF>

1 2 3 4 5

- 1 : Display dimming preset
- 2 : Brightness percentage 00 to 99
- 3 : Color palette
- 4 : Sentence Status Flag
- 5 : Checksum

13.11.1.2. Input data

Protocol

- Baud rate : 4800
- Data bit : 8 bit
- Parity : none
- Start bit : 1 bit
- Stop bit : 1 bit
- interval : Automatic (Automatic reception by the transmission cycle)
- version : IEC 61162-1

Data sentence

IEC 61162-1 RX2 (GPS) 1 port

RMC : Recommended minimum specific GNSS data

ZDA : Time and date

The priority of RX2 port sentence is as follows.

Date and time RMC > ZDA

Serial Alart 1 port

ACN : Alert command

Dimmer Serial 1 port

DDC : Display dimming control

Input data format

■ RMC – Recommended minimum specific GNSS data

\$--RMC,hhmmss.ss,A,lll.l, a,yyyy.yy,a,x.x,x.x,xxxxx,x.x,a,a,a*hh<CR><LF>

1 2 3 4 5 6 7 8 9 10 11

- 1 : UTC clock time
- 2 : Status A=Valid V=Invalid
- 3 : Latitude, N/S
- 4 : Longitude, E/W
- 5 : Speed over ground, knots
- 6 : Traveling bearing (degree)
- 7 : UTC Day, month, year
- 8 : Epoch reduction E/W
- 9 : Mode Indicator
 - A : GPS positioning
 - D : DGPS positioning
 - N : Not positioning
 - S : Simulation mode
- 10 : Navigational status
- 11 : Checksum

■ ZDA – Time and date

\$--ZDA,hhmmss.ss,xx,xx,xxxx,xx,xx*hh<CR><LF>

1 2 3 4 5 6 7

- 1 : UTC clock time
- 2 : Day, 01 to 31 (UTC)
- 3 : Month, 01 to 12 (UTC)
- 4 : Year (UTC)
- 5 : Local zone hours, 00 h to ±13 h
- 6 : Local zone minutes, 00 to ±59
- 7 : Checksum

■ ACN (Alarm command)

\$--ACN,hhmmss.ss,aaa,x.x,x.x,c,a*hh <CR><LF>

1 2 3 4 5 6 7

- 1 : Time
- 2 : Manufacturer mnemonic code
- 3 : Alert Identifier
- 4 : Alert Instance, 1 to 999999
- 5 : Alert command, A, Q, O or S
- 6 : Sentence status flag
- 7 : Checksum

■ DDC – Display dimming control

\$--DDC,a, xx,a,a*hh<CR><LF>

1 2 3 4 5

- 1 : Display dimming preset
- 2 : Brightness percentage 00 to 99
- 3 : Color palette
- 4 : Sentence Status Flag
- 5 : Checksum

13.11.2. IEC 61162-450 I/F

IP Address	172.16.60.124
Subnet mask	255.255.255.0
Transmission group	NAVD (239.192.0.4:60004 UDP)

Sentence I/O

\$VDVBW	Out
\$VDVLW	Out
\$VDDDC	In/Out (Receiving DDC is not always VD.)
\$VDALF	Out
\$VDALC	Out
\$VDARC	Out
\$--ACN	In
\$VDHBT	In/Out (Receiving HBT is not always VD.)
\$--RMC	In
\$--ZDA	In

13.12. JLN-741A/N Data Format

13.12.1. IEC 61162-1 Input/Output Data

13.12.1.1. Output data

Protocol

IEC 61162-1(NMEA0183)

Baud rate : 4800

Data bit : 8 bits

Parity : none

Start bit : 1

Stop bit : 1

interval : 1 sec

version : NMEA0183 ver1.5, 2.1, 2.3, 4.0, **IEC 61162-1**

version is selected by installation setting menu. Default value is IEC 61162-1 version.

In JLN-741A, a version cannot be selected. Only IEC61162-1 is allowed.

Data Sentences

 **CAUTION** The length of each sentence is variable. Make sure that sentences of any length can be received.

JLN-741A

IEC 61162-1 2 ports

VBW : Dual ground/water speed (JLN-741 outputs speed over water only)

VLW : Dual ground/water distance (JLN-741 outputs distance over water only)

Serial Alert 1 port

ALF : Alert sentence

ALC: Cyclic alert list

ARC: Alert command refused

JLN-741N

IEC 61162-1 1 port

VBW : Dual ground/water speed (JLN-741 outputs speed over water only)

VLW : Dual ground/water distance (JLN-741 outputs distance over water only)

Serial Alert 1 port

ALF : Alert sentence

ALC: Cyclic alert list

ARC: Alert command refused

Output data format

■ VBW – Dual ground/water speed

Version 1.5

No VBW sentence output

Version 2.1

\$VDVBW, x.x,x.x,A,x.x,x.x,A *hh<CR><LF>

1 2 3 4 5 6 11

Version 2.3, 4.0, IEC 61162-1

\$VDVBW, x.x,x.x,A,x.x,x.x,A,x.x,A,x.x,A*hh<CR><LF>

1 2 3 4 5 6 7 8 9 10 11

1	:	Fore/after speed over water, knots	“-“ = astern
2	:	Transverse speed over water, knots	“-“ = port
3	:	Status: speed over water	A = data valid, V = data invalid
4	:	Fore/after speed over the ground, knots	“-“ = astern
5	:	Transverse speed over the ground, knots	“-“ = port
6	:	Status: speed over the ground	A = data valid, V = data invalid
7	:	Stern starboard/port speed over water, knots	“-“ = port
8	:	Status: stern speed over water	A = data valid, V = data invalid
9	:	Stern starboard/port speed over the ground	“-“ = port
10	:	Status: stern speed over the ground	A = data valid, V = data invalid
11	:	Checksum	

■ VLW – Dual ground/water distance

Version 1.5

\$VDVLW, xxxx.x,N,xxx.xx,N<CR><LF>

1 2

Version 2.1, 2.3

\$VDVLW, x.x,N,x.x,N *hh<CR><LF >

1 2 3

1	:	Total distance, nautical miles
2	:	Trip distance, nautical miles
3	:	Checksum

Version 4.0, IEC 61162-1

\$VDVLW, x.x,N,x.x,N,x.x,N,x.x,N*hh<CR><LF>

1 2 3 4 5

1	:	Total water distance, nautical miles
2	:	Trip distance over water, nautical miles
3	:	Total distance over the ground, nautical miles
4	:	Trip distance over the ground, nautical miles
5	:	Checksum

■ ALF – Alert sentence

\$VDALF,x,x,x,hmmss.ss,a,a,aaa,x.x,x.x,x.x,c---c*hh <CR><LF>

1 2 3 4 5 6 7 8 9 10 11 12 13 14

- 15 : Total number of ALF sentences for this message, 1 to 2
- 16 : Sentence number, 1 to 2
- 17 : Sequential message identifier, 0 to 9
- 18 : Time of last change
- 19 : Alert category, A, B or C
- 20 : Alert priority, E, A, W or C
- 21 : Alert state, A, S, N, O, U or V
- 22 : Manufacturer mnemonic code
- 23 : Alert identifier
- 24 : Alert instance, 1 to 999999
- 25 : Revision counter, 1 to 99
- 26 : Escalation counter, 0 to 9
- 27 : Alert text
- 28 : Checksum

■ ALC – Cyclic alert list

\$VDALC,xx,xx,xx,x.x,aaa,x.x,x.x,x.x,.....,aaa,x.x,x.x,x.x*hh <CR><LF>

1 2 3 4 5 6 7 8 5 6 7 8 9

- 10 : Total number of sentences for this message, 01 to 99
- 11 : Sentence number, 01 to 99
- 12 : Sequential message identifier, 00 to 99
- 13 : Number of alert entries
- 14 : Manufacturer mnemonic code
- 15 : Alert identifier
- 16 : Alert instance
- 17 : Revision counter
- 18 : Checksum

■ ARC – Alert command refused

\$ VDARC, hhmss.ss, aaa, x.x, x.x, c*hh<CR><LF>

1 2 3 4 5 6

7 : Release time

8 : Alert specifically defined by the manufacturer

9 : Alert ID

10 : Alert instance

11 : Rejected alert command

12 : Checksum

13.12.1.2. Input data

Protocol

Baud rate : 4800

Data bit : 8 bit

Parity : none

Start bit : 1 bit

Stop bit : 1 bit

interval : Automatic (Automatic reception by the transmission cycle)

version : IEC 61162-1

Data sentence

Serial Alert 1 port

ACN : Alert command

Input data format

■ ACN (Alarm command)

\$--ACN,hhmss.ss,aaa,x.x,x.x,c,a*hh <CR><LF>

1 2 3 4 5 6 7

1 : Time

2 : Manufacturer mnemonic code

3 : Alert Identifier

4 : Alert Instance, 1 to 999999

5 : Alert command, A, Q, O or S

6 : Sentence status flag

7 : Checksum

13.13. About Chinese version RoHS

有害物质的名称及含量 (Names & Content of hazardous substances)

形式名(Type): JLN-740A/740N/741A/741N

名称(Name): Doppler Log

部件名称 (Part name)	有害物质 (Hazardous Substances)					
	铅 (Pb)	汞 (Hg)	镉 (Cd)	六价铬 (Cr(VI))	多溴联苯 (PBB)	多溴二苯醚 (PBDE)
室外装置 (Externally Mounted Equipment)	×	×	×	×	×	×
室内装置 (Internally Mounted Equipment)	×	○	○	○	○	○
外部设备(Peripherals) ·打印机(Printer) ·选择(Options) ·电线类(Cables) ·手册/Documents)	×	○	×	×	×	×

本表格依据SJ/T 11364 的规定编制。
(This table is prepared in accordance with the provisions of SJ/T 11364.)

○：表示该有害物质在该部件所有均质材料中的含量均在GB/T 26572 标准规定的限量要求以下。
(Indicates that this hazardous substance contained in all of the homogeneous materials for this part is below the requirement in GB/T 26572.)

×：表示该有害物质至少在该部件的某一均质材料中的含量超出GB/T 26572 标准规定的限量要求。
(Indicates that this hazardous substance contained in at least one of the homogeneous materials used for this part is above the limit requirement)

RE: 中华人民共和国电器电子产品有害物质限制使用管理办法
Measures for the Administration of the Restricted Use of the Hazardous Substances Contained in Electrical and Electronic Products of the People's Republic of China

Appendix A Menu list

A.1 Display menu list (NWZ-510SDW, NWZ-650SDR/NWZ-840SDR)

The menus for the main display (NWZ-510SDW) and remote display (NWZ-650SDR and NWZ-840SDR) are listed below.

Main display	Remote display	Menu item	Setting name	Setting value	User settings		Connected equipment	Description
					Current	Change		
<input type="radio"/>	<input type="radio"/>	TOUCH CAL (TOUCH SCREEN CALIBRATION)	TOUCH SCREEN CALIBRATION					adjustment of the touch position
<input type="radio"/>		MAINT INFO	MAINT INFO	Display only				Maintenance information JLN-740A only
<input type="radio"/>	<input type="radio"/>	THEME	ILLUMINATION	DAY,DUSK,NIGHT				Rough adjustment of brightness
<input type="radio"/>	<input type="radio"/>	DATE TIME (DATE/TIME[1/2])	YEAR	2000 to 2037				Year
			MONTH	JAN,FEB,MAR,APR, MAY,JUN,JUL,AUG, SEP,OCT,NOV,DEC				Month
			DAY	1 to last day of a month				Day
		(DATE/TIME[2/2])	HOUR	0 to 23				Hour
			MINUTE	0 to 59				Minute
<input type="radio"/>		ABOUT Main display	Display ver.:	Display only			NWZ-510SDW	Version of main display
			DP Proc .ver.:				NQA-7040	Version of distribution processor (JLN-740A only)
			SP Ctrl ver.:				NJC-70S	Signal processor control version
			SP Calc ver.:				NJC-70S	Signal processor computation version
			SP FPGA ver.:				NJC-70S	Signal processor FPGA version
			Display ser.:				NWZ-510SDW	Serial number of main display Note: 0000000 is displayed
			DP ser.:				NQA-7040	Serial number of main display (JLN-740A only) Note: 0000000 is displayed
			SP ser.:				NJC-70S	Serial number of main display Note: 0000000 is displayed
Transducer ser.:			NKF-547	Serial number of main display Note: 0000000 is displayed				
<input type="radio"/>		ABOUT Remote display	MF ver.:	Display only			NWZ-650SDR· NWZ-840SDR	Version of remote display
			MF ser.:					Serial number of main display Note: 0000000 is displayed

Main display	Remote display	Menu item	Setting name	Setting value	User settings		Connected equipment	Description				
					Current	Change						
○	○	ADV SET (ADVANCED SETTINGS)	Common ¹	CENTRL DIM (CENTRAL DIMMER)	INPUT	ETHERNET, UART 0, UART 1, UART 2, UART 3, ANY, NONE						
				ETH CONFIG (ETHERNET)	IP ADDRESS	Each device			Setting of IP address			
					SUBNET MASK				Setting of subnet mask			
					GATEWAY				Setting of gateway			
				UART CONFIG (UART [1/2])	UART	UART 0, UART 1, UART 2, UART 3			Setting of port			
					PARITY	NONE, ODD, EVEN, FORCED 1, FORCED 0			Setting of parity bit			
					STOP BITS	1, 2			Setting of stop bit			
				(UART [2/2])	DATA BITS	5, 6, 7, 8			Setting of data bit length			
					BAUD RATE	4800, 9600, 19200, 38400, 57600, 115200			Setting of baud rate			
				SERIAL MON (SERIAL MONITOR)	UART 0	Display only			Monitor of UART 0			
					UART 1				Monitor of UART 1			
					UART 2				Monitor of UART 2			
					UART 3				Monitor of UART 3			
				RESET (EXECUTE FACTORY RESET)	RESET				Reset of display			
				LOG	LOG	Display only			Display of log			
				NMEA TALKER (VBW)	TALKER	VD			Doppler	Setting of talker		
					USED/UNUSED	USED, UNUSED				Setting of used / unused		
				NMEA TALKER (VLW)	TALKER	VD			Doppler	Setting of talker		
					USED/UNUSED	USED, UNUSED				Setting of used / unused		
				NMEA TALKER (HBT)	TALKER	**			Doppler	Setting of talker		
					USED/UNUSED	USED, UNUSED				Setting of used / unused		
				NMEA TALKER (DDC)	TALKER	VD			Doppler	Setting of talker		
					USED/UNUSED	USED, UNUSED				Setting of used / unused		
				NMEA TALKER (JRCM)	TALKER	VD			Doppler	Setting of talker		
					USED/UNUSED	USED, UNUSED				Setting of used / unused		
				NMEA TALKER (JRC)	TALKER	VD			Doppler	Setting of talker		
					USED/UNUSED	USED, UNUSED				Setting of used / unused		
				ALERT ON/OFF	ALERT	ENABLED, DISABLED				Setting of Enabled/Disabled		
				NMEA SET	SENTENCE	DDC, NONE, VBW				Setting of sentence		
					INTERVAL[ms]	BY CHANGE, 100, 250, 500, 1000, 2000				Setting of interval		
					PORT	MULTI, UART 0, UART 1, UART 2, UART 3, TCP, OFF				Setting of port		
				○	ADV SET (ADVANCED SETTINGS) Main display	(ACK)	TALKER	**			Doppler	Setting of talker
							USED/UNUSED	USED, UNUSED				Setting of used / unused
(ALF)	TALKER	VD					Doppler	Setting of talker				
	USED/UNUSED	USED, UNUSED						Setting of used / unused				
(ACM)	TALKER	VD					Doppler	Setting of talker				
	USED/UNUSED	USED, UNUSED						Setting of used / unused				

Main display	Remote display	Menu item	Setting name	Setting value		User settings		Connected equipment	Description		
				Current	Change	Current	Change				
	○	DISP MODE (DISPLAY MODE SETTINGS)	ANALOG/DIGITAL	ANALOG, <u>DIGITAL</u>					Setting the analog display / digital display		
○	○	DIGITS	Number of digits	1, <u>2</u>					Setting of the number of decimal digits		
○	○	UNITS	SPEED	<u>kn</u> , m/s					Setting the speed unit		
○		SPEED LIMIT	UPPER	-40 to <u>40</u> , OFF					Setting of vessel speed upper limit		
			LOWER	<u>-40</u> to 40, OFF					Setting of vessel speed lower limit		
○		ADV SDME (ADVANCED SDME SETTINGS) Main display	TOTAL DIST (TOTAL DISTANCE SETTINGS)	TOTAL DIST.	<u>0.00</u> to 999999.99				Setting of total distance		
			DEMO MODE	INT/EXT	<u>INT</u> , EXT					Setting of demo output	
				PATTERN	<u>OFF</u> , 1 to 99					Setting of demo pattern	
			MODEL	MODEL RESET						Resetting of model	
			SYS TEST	SYSTEM TEST[1/2]	18kn TEST	<u>ON</u> , OFF					Setting of 18kn test
					LOST ALERT	<u>ON</u> , OFF					Setting of alert test
				SYSTEM TEST[2/2]	NW2 HW ALERT	<u>ON</u> , OFF					JLN-740A only
					NQA HW ALERT	<u>ON</u> , OFF					JLN-740A only
				NJC HW ALERT	<u>ON</u> , OFF					JLN-740A only	
			TRAN-SMIT	AUTO START	<u>ON</u> , OFF					Setting of auto start	
○		ADV SDME (ADVANCED SDME SETTINGS) Remote display	ANALOG	SPEED SCALE (DISPLAY MODE SETTINGS)	ANALOG SCALES	-2..10, -5..10, -4..20, -10..20, -5..25, <u>-6..30</u> , -8..40				Setting of analog display scale	
			MANAG NUMB (MANAGEMENT NUMBER SETTINGS)	MANAGEMENT NUMBER	NWZ-650SDR	10010701, 10010901, 10011101, 10011301, 10011501				Setting of management number	
					NWZ-840SDR	10011701, 10011901, 10012101, 10012301, 10012501				Setting of management number	
			COMM MODE (COMMUNICATION SETTINGS)	COMMUNICATION SETTINGS	<u>RX/TX</u> , RX ONLY					Setting of communication	
○	○	ALERT LIST	ALERT LIST	Display only				List of alert			
○		ALERT HIST	ALERT HIST	Display only				History of alert (JLN-740A only)			
	○	SOG/STW (SOG/STW SETTINGS)	SOG/STW	<u>GNSS SOG</u> , DOPPLER SOG, DOPPLER STW			NNN-21 Doppler	Setting of SOG/STW			

* The underlined value is the value that is set at the factory shipment. At the resetting, this value is set.

*1 Factory shipment value of main display: underline Factory shipment value of remote display : wave line Set value after the reset is set to factory shipment value.



● Display reset list

Main display(NWZ-510SDW)				
Menu item		Setting name	Setting value	ADV SET RESET
TOUCH CAL (TOUCH SCREEN CALIBRATION)		TOUCH SCREEN CALIBRATION		○
THEME		ILLUMINATION	<u>DAY</u> ,DUSK,NIGHT	
DATE TIME (DATE/TIME[1/2])		YEAR	2000 to 2037	
		MONTH	JAN,FEB,MAR,APR, MAY,JUN,JUL,AUG, SEP,OCT,NOV,DEC	
		DAY	End of 1 to MONTH	
(DATE/TIME[2/2])		HOURL	0 to 23	
		MINUTE	0 to 59	
ADV SET (ADVANCED SETTINGS) Common	ETH CONFIG (ETHERNET)	IP ADDRESS		○
		SUBNET MASK	Each device	○
		GATEWAY		○
	UART CONFIG (UART [1/2])	UART	<u>UART 0</u> ,UART 1, UART 2,UART 3	○
		PARITY	<u>NONE</u> ,ODD,EVEN, FORCED 1,FORCED 0	○
		STOP BITS	<u>1,2</u>	○
	(UART [2/2])	DATA BITS	<u>5,6,7,8</u>	○
		BAUD RATE	4800,9600,19200, 38400,57600,115200	○
	NMEA TALKER (DDC)	USED/UNUSED	<u>USED</u> ,UNUSED	○
	(JRCM)	USED/UNUSED	<u>USED</u> ,UNUSED	○
ALERT ON/OFF (ALERT ON/OFF)	ALERT	<u>ENABLED</u> ,DISABLED	○	
ADV SET (ADVANCED SETTINGS) Main display	CENTRL DIM (CENTRAL DIMMER)	INPUT	<u>ETHERNET</u> ,UART 0,UART 1, UART 2,UART 3,ANY,NONE	○
	UART CONFIG (UART [2/2])	PROTOCOL	<u>NMEA</u> ,XMODEM,MODBUS MASTER, PHONE,NONE	○
	NMEA TALKER (VBW)	USED/UNUSED	<u>USED</u> ,UNUSED	○
	(VLW)	USED/UNUSED	<u>USED</u> ,UNUSED	○
	(ACK)	USED/UNUSED	<u>USED</u> ,UNUSED	○
	(ALF)	USED/UNUSED	<u>USED</u> ,UNUSED	○
	(ACM)	USED/UNUSED	<u>USED</u> ,UNUSED	○
	(HBT)	USED/UNUSED	<u>USED</u> ,UNUSED	○
	(JRC)	USED/UNUSED	<u>USED</u> ,UNUSED	○
	NMEA SET	SENTENCE	<u>DDC</u> ,NONE,VBW	○
INTERVAL[ms]		<u>BY CHANGE</u> ,100,250,500, 1000,2000	○	
PORT		<u>MULTI</u> ,UART 0,UART 1,UART 2, UART 3,TCP,OFF	○	
DIGITS	Number of digits	<u>1,2</u>	○	
UNITS	SPEED	<u>kn</u> ,m/s	○	
SPEED LIMIT	UPPER	<u>-40</u> to <u>40</u> ,OFF		
	LOWER	<u>-40</u> to <u>40</u> ,OFF		
ADV SDME (ADVANCED SDME SETTINGS) Main display	TOTAL DIST (TOTAL DISTANCE SETTINGS)		TOTAL DIST.	<u>0.00</u> to 999999.99
	DEMO MODE		INT/EXT	<u>INT</u> ,EXT
			PATTERN	<u>OFF</u> ,1 to 99
	SYS TEST	SYSTEM TEST[1/2]	18kn TEST	<u>ON</u> ,OFF
			LOST ALERT	<u>ON</u> ,OFF
		SYSTEM TEST[2/2]	NW2 HW ALERT	<u>ON</u> ,OFF
			NQA HW ALERT	<u>ON</u> ,OFF
		NJC HW ALERT	<u>ON</u> ,OFF	
TRAN-SMIT	AUTO START	<u>ON</u> ,OFF		

* The underlined value is the value that is set at the factory shipment. At the resetting, this value is set.

* [○] shows the items to be reset to factory shipment values when run the reset.

* When the setting value of TOUCH CAL is reset, the position returns to the touch position at the factory shipment.

* Even if the setting value of THEME is reset, the setting value before resetting is maintained.

Remote display (NWZ-650SDR, NWZ-840SDR)					
Menu item		Setting name	Setting value	ADV SET RESET	
TOUCH CAL (TOUCH SCREEN CALIBRATION)		TOUCH SCREEN CALIBRATION			
THEME		ILLUMINATION	<u>DAY</u> ,DUSK,NIGHT	<input type="radio"/>	
DATE TIME (DATE/TIME[1/2])		YEAR	2000 to 2099		
		MONTH	JAN,FEB,MAR,APR, MAY,JUN,JUL,AUG, SEP,OCT,NOV,DEC		
		DAY	End of 1 to MONTH		
(DATE/TIME[2/2])		HOUR	0 to 23		
		MINUTE	0 to 59		
ADV SET (ADVANCED SETTINGS) Common	ETH CONFIG (ETHERNET)		IP ADDRESS	<input type="radio"/>	
			SUBNET MASK	Each device	<input type="radio"/>
			GATEWAY		<input type="radio"/>
	UART CONFIG (UART [1/2])		UART	UART 0,UART 1, UART 2,UART 3	<input type="radio"/>
			PARITY	NONE,ODD,EVEN, FORCED 1,FORCED 0	<input type="radio"/>
			STOP BITS	<u>1</u> ,2	<input type="radio"/>
	(UART [2/2])		DATA BITS	<u>5</u> ,6,7,8	<input type="radio"/>
			BAUD RATE	<u>4800</u> ,9600,19200, 38400,57600,115200	<input type="radio"/>
	NMEA TALKER (DDC)		USED/UNUSED	<u>USED</u> ,UNUSED	<input type="radio"/>
	(JRCM)		USED/UNUSED	<u>USED</u> ,UNUSED	<input type="radio"/>
ALERT ON/OFF (ALERT ON/OFF)		ALERT	<u>ENABLED</u> ,DISABLED	<input type="radio"/>	
ADV SET (ADVANCED SETTINGS) Remote display	CENTRL DIM (CENTRAL DIMMER)		INPUT	<u>ON</u> ,OFF	<input type="radio"/>
			OUTPUT	ETHERNET,NONE, <u>UART 0</u> ,UART 1, UART 2,UART 3	<input type="radio"/>
	UART CONFIG (UART [2/2])		PROTOCOL	NMEA,XMODEM, PHONE,NONE	<input type="radio"/>
	NMEA TALKER (VBW)	TALKER:GP	USED/UNUSED	<u>USED</u> ,UNUSED	<input type="radio"/>
		TALKER:VD	USED/UNUSED	<u>USED</u> ,UNUSED	<input type="radio"/>
	(VLW)	TALKER:GP	USED/UNUSED	<u>USED</u> ,UNUSED	<input type="radio"/>
		TALKER:VD	USED/UNUSED	<u>USED</u> ,UNUSED	<input type="radio"/>
	(HBT)	TALKER:GP	USED/UNUSED	<u>USED</u> ,UNUSED	<input type="radio"/>
		TALKER:VD	USED/UNUSED	<u>USED</u> ,UNUSED	<input type="radio"/>
	(DDC)		USED/UNUSED	<u>USED</u> ,UNUSED	<input type="radio"/>
	(JRCM)		USED/UNUSED	<u>USED</u> ,UNUSED	<input type="radio"/>
	(JRC)		USED/UNUSED	<u>USED</u> ,UNUSED	<input type="radio"/>
DISP MODE (DISPLAY MODE SETTINGS)		ANALOG/ DIGITAL	ANALOG, <u>DIGITAL</u>	<input type="radio"/>	
UNITS		SPEED	<u>kn</u> ,m/s	<input type="radio"/>	
ADV SDME (ADVANCED SDME SETTINGS) Remote display	ANALOG	SPEED SCALE (DISPLAY MODE SETTINGS)	ANALOG SCALES	<input type="radio"/>	
	MANAG NUMB (MANAGEMENT NUMBER SETTINGS)		MANAGEMENT NUMBER	<input type="radio"/>	
	COMM MODE (COMMUNICATION SETTINGS)		COMMUNICATION SETTINGS	<u>RX/TX</u> , RX ONLY	<input type="radio"/>
SOG/STW (SOG/STW SETTINGS)		SOG/STW	<u>GNSS SOG</u> , DOPPLER SOG,DOPLER STW	<input type="radio"/>	

* The underlined value is the value that is set at the factory shipment. At the resetting, this value is set.

* [○] shows the items to be reset to factory shipment values when run the reset.

* When the setting value of TOUCH CAL is reset, the position returns to the touch position at the factory shipment.

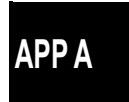

A.2 Display menu list (NWZ-4640)

Main menu	Submenu	Range	Remarks
1. DISPLAY	1. LCD		
	1. CONTRAST	1,2,3,4,5,6,7, 8 ,9,10,11,12,13	
	2. DIMMER MAXIMUM	4,5,6,7,8,9,10, 11 ,12,13	
	3. DIMMER TYPICAL	3,4,5,6, 7 ,8,9,10,11,12	
	4. DIMMER MINIMUM	2, 3 ,4,5,6,7,8,9,10,11	
	2. CLICK SOUND	ON / OFF	
	3. DISPLAY SELECTION		
	1. DISPLAY1	OFF/SEG.1/2/3/4/ SPECIAL /GRA.	
	SEGMENTATION1		
	1. DISPLAY		
	DOPPLER	STW / TRIP / TOTAL	
	OFF		
	2. DISPLAY MODE	NORMAL / SPECIAL1 / SPECIAL2 / AUTO RANGE	
	3. AUTO SCREEN	ON / OFF	
	4. SOUND	SOUND1 / SOUND2 / OFF	
	5. TIME	1-10sec	
	SEGMENTATION2		
	1. DISPLAY1/2	Same as DISPLAY 1/1	
	2. DISPLAY2/2	Same as DISPLAY 1/1	
	3. AUTO SCREEN	ON / OFF	
	4. SOUND	SOUND1 / SOUND2 / OFF	
	5. TIME	1-10sec	
	SEGMENTATION3		
	1. DISPLAY1/3	Same as DISPLAY 1/1	
	2. DISPLAY2/3	Same as DISPLAY 1/1	
	3. DISPLAY3/3	Same as DISPLAY 1/1	
	4. AUTO SCREEN	ON / OFF	
	5. SOUND	SOUND1 / SOUND2 / OFF	
	6. TIME	1-10sec	
	SEGMENTATION4		
	1. DISPLAY1/4	Same as DISPLAY 1/1	
	2. DISPLAY2/4	Same as DISPLAY 1/1	
	3. DISPLAY3/4	Same as DISPLAY 1/1	
	4. DISPLAY4/4	Same as DISPLAY 1/1	
	5. AUTO SCREEN	ON / OFF	
	6. SOUND	SOUND1 / SOUND2 / OFF	
	7. TIME	1-10sec	
	SPECIAL		
	1. DISPLAY	STW1 / STW2 / STW3	
	2. AUTO SCREEN	ON / OFF	
	3. SOUND	SOUND1 / SOUND2 / OFF	
	4. TIME	1 ,2,3,4,5,6,7,8,9,10sec	
	GRAPHIC		
	1. DISPLAY	STW	
	2. AUTO SCREEN	ON / OFF	
	3. SOUND	SOUND1 / SOUND2 / OFF	
	4. TIME	1-10sec	
2. DISPLAY2	Same as DISPLAY1 SPECIAL, STW2		
3. DISPLAY3	Same as DISPLAY1 SPECIAL, STW1		
4. DISPLAY4	Same as DISPLAY1 OFF		
5. DISPLAY5	Same as DISPLAY1 OFF		
6. DISPLAY6	Same as DISPLAY1 OFF		
4. BACK LIGHT	WHITE / ORANGE		

2. SYSTEM	1. UNIT		
	1. SPEED	<u>kn</u> / m/s	ADMIN(MAINTENACE) MODE
	2. SMOOTHING		
3. LANG.	1. STW	10-240sec	ADMIN(MAINTENACE) MODE
	3. SPEED DEC. NUM	1, <u>2</u>	ADMIN(MAINTENACE) MODE
	1. LANG.	<u>English</u> /(Japanese)	ADMIN(MAINTENACE) MODE
4. NOTICE	1. SPEED		
	1. MAXIMUM	-40 to +40kn	
	2. MINIMUM	-40 to +40kn	
5. SENSOR	3. CONFIRM		
	1. SPEED CORR	-50 to +50%	ADMIN(MAINTENACE) MODE
	※1 2. NMEA	1.5/2.3/IEC	ADMIN(MAINTENACE) MODE
	※1 3. PULSE1	0-99 ×100P/NM	ADMIN(MAINTENACE) MODE
	※1 4. SCALE	10-40	ADMIN(MAINTENACE) MODE
6. DATE-TIME ※1	※1 5. CONFIRM		ADMIN(MAINTENACE) MODE
	1. DATE		JLN-740N only
	※1 2. TIME		JLN-740N only
7. ALERT HISTORY	※1 3. CONFIRM		
			JLN-740N only
8. ALERT LIST			
9. BUBBLE SETTINGS.	1. BUBBLE THR.	0-80000	Default 50000
	2. CONFIRM		
10. MAINT INFO			JLN-740N only

* Set value of the underline is the value of the factory.

Initial values other than underline setting values (other than DISPLAY, SYSTEM, and LANG.) are the initial values of the system's shipment.

* 1 item is not displayed in JLN-741N.

Maintenance menu : Do not change this section.

Main menu	Submenu	Range	Remarks
From 1 to 6 is same as Normal MENU			
7. INTERFACE	1. DATA I/O		
	1. DATA IN/OUT1		
	NMEA		Change prohibited
	1. DATA IN/OUT	SEND/RECEIVE	Change prohibited
	1. VERSION	1.5/2.1/2.3/4.0	Transmission only
	SENTENCE	Sentence list ACK VBW VLW OFF	Change prohibited
	2. BIT RATE	4800/9600/ 19200 /38400	Change prohibited
	IEC		
	1. DATA IN/OUT	SEND/RECEIVE	
	SENTENCE	Sentence list ACK VBW VLW	Transmission only
	2. BIT RATE	4800/9600/19200/38400	
	2. DATA IN/OUT2		
	NMEA		
	1. DATA IN/OUT	SEND/RECEIVE	Change prohibited
	1. VERSION	1.5 /2.1/2.3/4.0	Transmission only
	SENTENCE	Sentence list ACK VBW VLW OFF	Transmission only
	2. BIT RATE	4800/9600/19200/38400	
	IEC		
	1. DATA IN/OUT	SEND/RECEIVE	Change prohibited
	SENTENCE	Sentence list ACK VBW VLW OFF	Transmission only
	2. BIT RATE	4800 /9600/19200/38400	
	2. DATA IN/OUT3		
	NMEA		Change prohibited
	1. DATA IN/OUT	SEND/ RECEIVE	Change prohibited
	1. VERSION	1.5/2.1/2.3/4.0	Transmission only
	SENTENCE	Sentence list ACK VBW VLW	Transmission only
	2. BIT RATE	4800/9600/ 19200 /38400	Change prohibited
	IEC		
	1. DATA IN/OUT	SEND/RECEIVE	
	SENTENCE	Sentence list ACK VBW VLW	Transmission only
	2. BIT RATE	4800/9600/19200/38400	
	4. RS-485		
NMEA			
1. VERSION	1.5/2.1/2.3/4.0	Transmission only	
SENTENCE	Sentence list ACK VBW VLW	Transmission only	
2. BIT RATE	38400/57600/76800/115200		
IEC			
1. SENTENCE	Sentence list ACK VBW VLW OFF	Transmission only	
2. BIT RATE	38400/57600/76800/ 115200		
5. CONTACT INPUT	DIMMER/ACK		
2. DIAGNOSIS	-		
ERROR LOG OUT	-		

* In the JLN - 741N, the normal menu is 1 to 5. Equipment menu will be 6 ~ 16.

8.MAINTENANCE	1. INPUT DATA		
	2. DIAGNOSIS		
	1. DISPLAY DIAG		
	2. MONITOR TEST		
	3. BUZZER TEST		
	3. ERROR LOG		
	1. ALERT		
	2. ERROR LOG		
	4. SOFT VERSION		
	1. DISPLAY VER		
	1. APP VER		
	2. SERIAL NUMBER		
	3. BARCODE		
5. TX		<u>ON</u> /OFF	
9. MASTER RESET	1. TOTAL RESET		
	1. TOTAL ADJ		
	2. DISPLAY RESET		
1. DISPLAY			
10. DEMO MODE	1. DEMO PATTERN	-5 / 0 / 18 / 36 / 40 / OFF	
11. SOFT UPDATE	1. DISPLAY		
12. DISPLAY MODEL		<u>JLN-740N</u> /JLN-741N	
13. RS-485ID		<u>1</u> -10	
14. DIMMER GROUP		<u>1</u> -10	
15. DIMMER		<u>KEY</u> /EXT DIMMER	
16. AUTO START		ON/ <u>OFF</u>	
17. SYSTEM TEST	1. 18kn TEST	ON/OFF	
	2. LOST ALERT	ON/OFF/SOG/DISPLAY	
	3. NWZ HW ALERT	ON/OFF	JLN-740N only
	4. NQA HW ALERT	ON/OFF	JLN-740N only
	5. NJC HW ALERT	ON/OFF	JLN-740N only
	6. CONFIRM		

* Set value of the underline is the value of the factory.

The initial value of the setting without underlining is the initial value of the system's shipping.

* In the JLN - 741N, the normal menu is 1 to 5. Equipment menu will be 6 ~ 16.

A.3 Maintenance software menu list

- JLN-740A, JLN-740N

Set value of the underline is the value of the factory.

Menu item	Item name	Setting name	Setting value	User settings		Description
				Current	Change	
First Settings	VD4 Start Measure	Measure	<u>Stopped</u> , Started			Start of transmission
	VD6 Speed Calculation Configuration	Speed Correlation	-50.0 to <u>0.0</u> to 50.0			Correction of ship speed
	VD10 Distance Reset	Total Distance	0 to <u>0.0</u> to 999999.99			Setting of total distance
	VD12 Vessel Size Information Configuration	X:-999.9 to 999.9[m]	-999.9 to <u>0.0</u> to 999.9			Transducer installation position (port/starboard) * JLN-750 only
		Y:0.0 to 999.9[m]	<u>0.0</u> to 999.9			Transducer installation position (bow/stern) * JLN-750 only
		Y:0.0 to 999.9[m]	<u>0.0</u> to 999.9			Vessel's heading speed position * JLN-750 only
	VD14 Depth Configuration	Y:0.0 to 999.9[m]	<u>0.0</u> to 999.9			Stern speed position * JLN-750 only
		Draft [m]	-100.0 to <u>0.0</u> to +100.0			Draft
	VD18 System Test Status	TEST 18kn	Enabled : Red Disabled : Green			System test (18kn test)
		LOST SPEED	Enabled : Red Disabled : Green			System test (lose speed alert)
		Main Display HW ERROR	Enabled : Red Disabled : Green			System test (Main Display hardware error)
		Distribution Processor HW ERROR	Enabled : Red Disabled : Green			System test (distribution processor hardware error)
		Signal Processor HW ERROR	Enabled : Red Disabled : Green			System test (signal processor hardware error)
	VD26 System Time Configuration	System Time(Year) 2000-2037	2000 to <u>2016</u> to 2037			System Time (Year)
		System Time(Month)	<u>1</u> to 12			System Time (Month)
		System Time(Day)	<u>1</u> to 31			System Time (Day)
		System Time(Hour)	<u>0</u> to 23			System Time (hour)
		System Time(Minute)	<u>0</u> to 59			System Time (minute)
		System Time(Second)	<u>0</u> to 59			System Time (second)
	VD35 Transducer Mounting(NKF-547) Information	Model Name	Up to 9 ASCII characters			Model name (NKF-547/531E)
		Serial Number	Up to 10 ASCII characters			Serial number (NKF-547/531E)
		Barcode Number	Up to 13 ASCII characters			Bar code number (NKF-547/531E)
	VD36 Signal Processor(NJC-70S/D) Errors	No Bubble Reference	Normal : Green Abnormal : Red	Displayed only		Bubble detection reference abnormality
VD38 Remote Display Configuration	Remote Display(1) Type	NWZ-4610, <u>NWZ-650SDR/840SDR</u>			Select Remote display(1)	
	Remote Display(2) Type	NWZ-4610, <u>NWZ-650SDR/840SDR</u>			Select Remote display(2)	
VD39 Analog Display(NWW-24/25/26) Configuration	Analog Full Scale	20 to <u>30</u> to 40			Analog full scale	
VD44 LOG Pulse Configuration	LOG Pulse Type	100, <u>200</u> ,400			LOG pulse type	
VD48 Brightness Control Configuration	Dimming Controller	<u>Not Use</u> ,Dimmer Unit(NCM-227),Main Display,Serial Dimmer(DDC),Serial ROT(DDC),Serial GPS(DDC), Serial Spare(DDC),Ethernet(DDC)			Brightness control mode	
VD85 Serial Alert Configuration	Alert On Serial	<u>Use</u> , <u>ALF/ACN/ALC/ARC/HBT</u> , <u>Use ACK</u>			Serial alert type	
	"Rectified-unacknowledged" State	<u>Not Use</u> , <u>Use</u> , <u>"Rectified-unacknowledged"</u>			Whether "Rectified – Unacknowledged" state is used by ALR or not	

Menu item	Item name	Setting name	Setting value		User settings		Description
					Current	Change	
All Settings	VD1 Main Display(NWZ-510SD W/NWZ-4640) Status	[d]	0 to 9999	Display only			Total operation time (Main display-Day)
	VD1 Main Display(NWZ-510SD W/NWZ-4640) Status	[h]	0 to 23	Display only			Total operation time (Main display-Hour)
		[m]	0 to 59	Display only			Total operation time (Main display-Minute)
		RAM Error	Normal : Green Abnormal : Red	Display only			RAM abnormality (Main display)
		ROM Error	Normal : Green Abnormal : Red	Display only			ROM abnormality (Main display)
	VD2 Distribution Processor(NQA-7040) Status	[d]	0 to 9999	Display only			Total operation time (distribution processor – Day)
		[h]	0 to 23	Display only			Total operation time (distribution processor – Time)
		[m]	0 to 59	Display only			Total operation time (distribution processor – Minute)
		Serial Error	Normal : Green Abnormal : Red	Display only			Serial IC abnormality (distribution processor)
		DAC Error	Normal : Green Abnormal : Red	Display only			DAC abnormality (distribution processor)
		Ethernet Error	Normal : Green Abnormal : Red	Display only			Ethernet IC abnormality (distribution processor)
		RAM Error	Normal : Green Abnormal : Red	Display only			RAM abnormality (distribution processor)
		ROM Error	Normal : Green Abnormal : Red	Display only			ROM abnormality (distribution processor)
		EEPROM Error	Normal : Green Abnormal : Red	Display only			EEPROM abnormality (distribution processor)
	VD3 Signal Processor(NJC-70S/D) Status	[d]	0 to 9999	Display only			Total operation time (signal processor – day)
		[h]	0 to 23	Display only			Total operation time (signal processor – hour)
		[m]	0 to 59	Display only			Total operation time (signal processor – minute)
		[degC]	Display only				Frame temperature (signal processor)
		[Volt]	Display only				Power supply voltage (48V)
		[Volt]	Display only				Power supply voltage (5V-Ch1)
		[Volt]	Display only				Power supply voltage (5V-Ch2)
		RAM Error	Normal : Green Abnormal : Red	Display only			RAM abnormality (control CPU)
		ROM Error	Normal : Green Abnormal : Red	Display only			ROM abnormality (control CPU)
		EEPROM Error	Normal : Green Abnormal : Red	Display only			EEPROM abnormality (control CPU)
	VD4 Start Measure	Measure	Stopped,Started				Start of transmission
	VD6 Speed Calculation Configuration	Speed Correlation	-50.0 to 0.0 to 50.0				Correction of vessel speed
	VD9 Alert Status	Integrated Alert	Normal : Green Abnormal : Red	Display only			Integrated alert flag



Menu item	Item name	Setting name	Setting value		User settings		Description
					Current	Change	
All Settings	VD9 Alert Status	Lost Speed	Normal : Green Abnormal : Red	Display only			Lost speed alert (fore/after)
		Lost Transverse Speed	Normal : Green Abnormal : Red	Display only			Lost speed alert (port/starboard)
		Over Speed	Normal : Green Abnormal : Red	Display only			Fore/after vessel speed notice (upper limit)
		Low Speed	Normal : Green Abnormal : Red	Display only			Fore/after vessel speed notice (lower limit)
		Bubble Detected	Normal : Green Abnormal : Red	Display only			Bubble detection
		Software Updated	Normal : Green Abnormal : Red	Display only			Software updated
		Maintenance Mode	Normal : Green Abnormal : Red	Display only			Maintenance mode
		Reboot Required	Normal : Green Abnormal : Red	Display only			Reboot required
		VD1 Alert	Normal : Green Abnormal : Red	Display only			PJRCM,VD,1 integrated alert
		VD2 Alert	Normal : Green Abnormal : Red	Display only			PJRCM,VD,2 integrated alert
		VD3 Alert	Normal : Green Abnormal : Red	Display only			PJRCM,VD,3 integrated alert
		VD36 Alert	Normal : Green Abnormal : Red	Display only			PJRCM,VD,36 integrated alert
		VD47 Alert	Normal : Green Abnormal : Red	Display only			PJRCM,VD,47 integrated alert
	VD10 Distance Reset	Total Distance	0 to 999999.99				Setting of total distance
	VD12 Vessel Size Information Configuration	X:-999.9 to 999.9[m]	-999.9 to 0.0 to 999.9				Transducer installation position (port/starboard) * JLN-750 only
		Y:0.0 to 999.9[m]	0.0 to 999.9				Transducer installation position (bow/stern) * JLN-750 only
		Y:0.0 to 999.9[m]	0.0 to 999.9				Fore speed position * JLN-750 only
		Y:0.0 to 999.9[m]	0.0 to 999.9				After speed position * JLN-750 only
	VD13 Transducer Angle Configuration	[deg]	-180.0 to 0.0 to 180.0				Transducer angle correction (fore/after: Yaw)
		[deg]	-180.0 to 0.0 to 180.0				Transducer angle correction (fore/after: Pitch)
		[deg]	-180.0 to 0.0 to 180.0				Transducer angle correction (Port/starboard: Yaw)
[deg]		-180.0 to 0.0 to 180.0				Transducer angle correction (Port/starboard: Roll)	
VD14 Depth Configuration	Draft [m]	-100.0 to 0.0 to +100.0				Draft	
VD18 System Test Status	TEST 18kn	Enabled : Red Disabled : Green				System test (18kn test)	

Menu item	Item name	Setting name	Setting value		User settings		Description
					Current	Change	
All Settings	VD18 System Test Status	LOST SPEED	Enabled : Red Disabled : Green				System test (Lost speed alert)
		Main Display HW ERROR	Enabled : Red Disabled : Green				System test (Main display hardware error)
		Distribution Processor HW ERROR	Enabled : Red Disabled : Green				System test (Distribution processor hardware error)
		Signal Processor HW ERROR	Enabled : Red Disabled : Green				System test (Signal processor hardware error)
	VD19 Power Detect Value	Ch1:	0 to 4096	Display only			Travelling wave (Ch1: Fore direction)
		Ch2:	0 to 4096	Display only			Travelling wave (Ch2: After direction)
		Ch3:	0 to 4096	Display only			Travelling wave (Ch3: Starboard direction)
		Ch4:	0 to 4096	Display only			Travelling wave (Ch4: Port direction)
	VD26 System Time Configuration	System Time(Year) 2000-2037	2000 to <u>2016</u> to 2037				System Time (Year)
		System Time(Month)	<u>1</u> to 12				System Time (Month)
		System Time(Day)	<u>1</u> to 31				System Time (Day)
		System Time(Hour)	<u>0</u> to 23				System Time (Hour)
		System Time(Minute)	<u>0</u> to 59				System Time (Minute)
		System Time(Second)	<u>0</u> to 59				System Time (Second)
	VD27 Support Frequency Status	NJC-70:	2.0,---	Display only			Supported frequency (NJC-70S/D)
		CDC-7400(1):	2.0,---	Display only			Supported frequency (CDC-7400 (1))
		CDC-7400(2):	2.0,---	Display only			Supported frequency (CDC-7400 (2))
		CMN-7400(1):	2.0,---	Display only			Supported frequency (CMN-7400 (1))
		CMN-7400(2):	2.0,---	Display only			Supported frequency (CMN-7400 (2))
	VD35 Transducer Mounting(NKF-547) Information	Model Name	Up to 9 ASCII characters				Model name (NKF-547/531E)
		Serial Number	Up to 10 ASCII characters				Serial number (NKF-547/531E)
		Barcode Number	Up to 13 ASCII characters				Bar code number (NKF-547/531E)
	VD36 Signal Processor(NJC-70S/D) Errors	No Bubble Reference	Normal : Green Abnormal : Red	Displayed only			Bubble detection reference abnormality
		Power Fail(1)	Normal : Green Abnormal : Red	Display only			Transmission power fail (1 axis)
		Power Fail(2)	Normal : Green Abnormal : Red	Display only			Transmission power fail (2 axes)
		PA Error(1)	Normal : Green Abnormal : Red	Display only			PA1 error
PA Error(2)		Normal : Green Abnormal : Red	Display only			PA2 error	

APPA

Menu item	Item name	Setting name	Setting value		User settings		Description
					Current	Change	
All Settings	VD36 Signal Processor(NJC-70S/D) Errors	PA Error(3)	Normal : Green Abnormal : Red	Display only			PA3 error
		PA Error(4)	Normal : Green Abnormal : Red	Display only			PA4 error
		RSLT Error(1)	Normal : Green Abnormal : Red	Display only			RSLT1 error
		RSLT Error(2)	Normal : Green Abnormal : Red	Display only			RSLT2 error
		RSLT Error(3)	Normal : Green Abnormal : Red	Display only			RSLT3 error
		RSLT Error(4)	Normal : Green Abnormal : Red	Display only			RSLT4 error
		Frequency Measure Error	Normal : Green Abnormal : Red	Display only			Frequency detection abnormality (Ch1)
		Frequency Measure Error	Normal : Green Abnormal : Red	Display only			Frequency detection abnormality (Ch2)
		Frequency Measure Error	Normal : Green Abnormal : Red	Display only			Frequency detection abnormality (Ch3)
		Frequency Measure Error	Normal : Green Abnormal : Red	Display only			Frequency detection abnormality (Ch4)
		FPGA Configuration Fail	Normal : Green Abnormal : Red	Display only			FPGA configuration abnormality (1 axis)
		FPGA Configuration Fail	Normal : Green Abnormal : Red	Display only			FPGA configuration abnormality (2 axes)
		Supported Frequency	Normal : Green Abnormal : Red	Display only			Supported frequency abnormality
		High Temperature	Normal : Green Abnormal : Red	Display only			Signal processor temperature abnormality
		Voltage Error(48V)	Normal : Green Abnormal : Red	Display only			Voltage abnormality (signal processor 48V)
		Voltage Error(5V-1)	Normal : Green Abnormal : Red	Display only			Voltage abnormality (signal processor 5V-Ch1)
		Voltage Error(5V-2)	Normal : Green Abnormal : Red	Display only			Voltage abnormality (signal processor 5V-Ch2)

Menu item	Item name	Setting name	Setting value		User settings		Description
					Current	Change	
All Settings	VD36 Signal Processor(NJC-70S/D) Errors	Software Version	Normal : Green Abnormal : Red	Display only			Software version abnormality (computation CPU1)
		Software Version	Normal : Green Abnormal : Red	Display only			Software version abnormality (computation CPU2)
		Software Version	Normal : Green Abnormal : Red	Display only			Software version abnormality (computation CPU3)
		Software Version	Normal : Green Abnormal : Red	Display only			Software version abnormality (computation CPU4)
		Software Version	Normal : Green Abnormal : Red	Display only			Software version abnormality (FPGA1)
		Software Version	Normal : Green Abnormal : Red	Display only			Software version abnormality (FPGA2)
	VD38 Remote Display Configuration	Remote Display(1) Type	NWZ-4610,NWZ-650SDR/840SDR				Select Remote display(1)
		Remote Display(2) Type	NWZ-4610,NWZ-650SDR/840SDR				Select Remote display(2)
	VD39 Analog Display(NWW-24/25/26) Configuration	Analog Full Scale	20 to <u>40</u>				Analog full scale
	VD40 NMEA Version Configuration	NMEA Version(Serial Tx1)	NMEA Version 1.5,NMEA Version 2.1,NMEA Version 2.3,NMEA Version 4.0, <u>IEC 61162</u>				NMEA version 1 (serial)
		NMEA Version(Serial Tx2)	NMEA Version 1.5,NMEA Version 2.1,NMEA Version 2.3,NMEA Version 4.0, <u>IEC 61162</u>				NMEA version 2 (serial)
		NMEA Version(Ethernet)	NMEA Version 1.5,NMEA Version 2.1,NMEA Version 2.3,NMEA Version 4.0, <u>IEC 61162</u>				NMEA version 3(LAN)
	VD41 JRC-RMS Configuration	RMS Output(Serial)	<u>Disable</u> ,Enable				RMS Enable flag (serial)
		RMS Output(Ethernet)	Disable, <u>Enable</u>				RMS Enable flag (LAN)

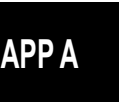

Menu item	Item name	Setting name	Setting value		User settings		Description	
					Current	Change		
All Settings	VD42 Ethernet Configuration For Main Display Port	IP Address	0.0.0.0 to <u>172.16.0.2</u> to 255.255.255.255				IP address	
		Subnet Mask	0.0.0.0 to <u>255.255.0.0</u> to 255.255.255.255				Subnet mask	
		MAC Address	00:00:00:00:00:00 to <u>00:00:27:00:00:02</u> to FF:FF:FF:FF:FF:FF				MAC address	
	VD43 IEC 61162-450 Tx Group For NWZ-510SDW	Transmission Group(to Main Display)	MISC(239.192.0.1: 60001), TGTD(239.192.0.2: 60002), SATD(239.192.0.3: 60003), <u>NAVD(239.192.0.4: 60004)</u> , VDRD(239.192.0.5: 60005), RCOM(239.192.0.6: 60006), TIME(239.192.0.7: 60007), PROP(239.192.0.8: 60008), USR1(239.192.0.9: 60009), USR2(239.192.0.10: 600010), USR3(239.192.0.11: 600011), USR4(239.192.0.12: 600012), USR5(239.192.0.13: 600013), USR6(239.192.0.14: 600014), USR7(239.192.0.15: 600015), USR8(239.192.0.16: 600016)				Main display oriented transmission group	
	VD43 IEC 61162-450 Tx Group For NWZ-510SDW	Transmission Group(from Main Display)	MISC(239.192.0.1: 60001), TGTD(239.192.0.2: 60002), SATD(239.192.0.3: 60003), NAVD(239.192.0.4: 60004), VDRD(239.192.0.5: 60005), RCOM(239.192.0.6: 60006), TIME(239.192.0.7: 60007), PROP(239.192.0.8: 60008), USR1(239.192.0.9: 60009), USR2(239.192.0.10: 600010), USR3(239.192.0.11: 600011), USR4(239.192.0.12: 600012), USR5(239.192.0.13: 600013), USR6(239.192.0.14: 600014), USR7(239.192.0.15: 600015), USR8(239.192.0.16: 600016)				Main display oriented reception group	
	VD44 LOG Pulse Configuration	LOG Pulse Type	100, <u>200</u> ,400				LOG pulse type	
	VD45 ROT Input Configuration	Model	<u>Disable:JLN-740 Series</u> Enable:JLN-750 Series				Model selection	
		ROT Auto Select	Static ROT Input, <u>Use ROT Auto Select</u>				ROT sentence priority switching * JLN-750 only	
		ROT Auto Select Interval	10 to <u>30</u> to 1800				ROT sentence priority switching time * JLN-750 only	
		ROT Lost Limit	10 to <u>30</u> to 1800				ROT sentence non-input permissible time * JLN-750 only	
	VD46 IEC 61162-450 SFI Number	Source SFI number	0000 to <u>9999</u>				61162-450 transmission source ID	
	VD47 Error Flags On Distribution Processor(NQA-7040)	Lost ROT Input	Normal : Green Abnormal : Red	Display only				ROT sentence non-input
		RTC Initialized	Normal : Green Abnormal : Red	Display only				RTC initialization
		Lost Date-Time Input	Normal : Green Abnormal : Red	Display only				Clock time sentence non-input
	VD48 Brightness Control Configuration	Dimming Controller	<u>Not Use</u> .Dimmer Unit(NCM-227),Main Display,Serial Dimmer(DDC),Serial ROT(DDC),Serial GPS(DDC), Serial Spare(DDC),Ethernet(DDC)				Brightness control mode	

Menu item	Item name	Setting name	Setting value		User settings		Description	
					Current	Change		
All Settings	VD48 Brightness Control Configuration	DDC Talker Filter	Disable, Enable				Talker filter Enable flag	
		Talker Filter	AA to <u>VD</u> to ZZ				Talker	
		SFI number(For Ethernet)	0000 to 9999				SFI number	
	VD49 Date-Time Auto Calibration	Date-Time Auto Select	Static Date-Time Input, <u>Use Date-Time Auto Select</u>				Clock Time sentence priority switching	
		Date-Time Auto Select Interval	10 to <u>30</u> to 1800				Clock time sentence priority switching time	
		Date-Time Lost Limit	10 to <u>30</u> to 1800				Clock time sentence non-input permissible time	
	VD50 Power Control Flag	Shutdown Requested	Normal : Green Abnormal : Red	Display only				Shut-down requested
		Reboot Requested	Normal : Green Abnormal : Red	Display only				Reboot requested
	VD59 Channel Enable Flag	Channel 1	Disable, Enabled				Channel 1 valid flag	
		Channel 2	Disable, Enabled				Channel 2 valid flag	
		Channel 3	Disable, Enabled				Channel 3 valid flag	
		Channel 4	Disable, Enabled				Channel 4 valid flag	
	VD75 Cluster identifier	Transmission Group(to CAM)	MISC, TGTD, SATD, NAVD, VDRD, RCOM, TIME, PROP, USR1, USR2, USR3, USR4, USR5, USR6, USR7, USR8, AM1, BAM2, CAM1, CAM2, NETA					
		Transmission Group(from CAM)	MISC, TGTD, SATD, NAVD, VDRD, RCOM, TIME, PROP, USR1, USR2, USR3, USR4, USR5, USR6, USR7, USR8, AM1, BAM2, CAM1, CAM2, NETA					
		Cluster	Nav				The cluster identification field consists of a maximum of 15 characters.	
	VD76 Ethernet Configuration For Maintenance Port	IP Address Preset	<u>IEC 61162-450 Conformity</u> , JRC Standard, Enable Any Address				IP address preset	
		IP Address	0.0.0.0 to <u>172.16.60.124</u> to 255.255.255.255				IP address	
		Subnet Mask	0.0.0.0 to <u>255.255.0.0</u> to 255.255.255.255				Subnet mask	
		MAC Address	00:00:00:00:00:00 to <u>00:00:27:00:00:01</u> to FF:FF:FF:FF:FF:FF				MAC address	
	VD77 Tx Group From JLN-740/750 Series To JRC-RMS	Transmission Group(for JRC-RMS)	MISC(239.192.0.1: 60001), TGTD(239.192.0.2: 60002), SATD(239.192.0.3: 60003), NAVD(239.192.0.4: 60004), VDRD(239.192.0.5: 60005), RCOM(239.192.0.6: 60006), TIME(239.192.0.7: 60007), PROP(239.192.0.8: 60008), USR1(239.192.0.9: 60009), USR2(239.192.0.10: 600010), USR3(239.192.0.11: 600011), USR4(239.192.0.12: 600012), USR5(239.192.0.13: 600013), USR6(239.192.0.14: 600014), USR7(239.192.0.15: 600015), USR8(239.192.0.16: 600016)				RMS oriented transmission group	

APPA

Menu item	Item name	Setting name	Setting value	User settings		Description
				Current	Change	
	VD78 Tx Group From JLN-740/750 Series	Transmission Group(for IEC 61162-450)	MISC(239.192.0.1: 60001), TGTD(239.192.0.2: 60002), SATD(239.192.0.3: 60003), <u>NAVD(239.192.0.4: 60004)</u> , VDRD(239.192.0.5: 60005), RCOM(239.192.0.6: 60006), TIME(239.192.0.7: 60007), PROP(239.192.0.8: 60008), USR1(239.192.0.9: 60009), USR2(239.192.0.10: 600010), USR3(239.192.0.11: 600011), USR4(239.192.0.12: 600012), USR5(239.192.0.13: 600013), USR6(239.192.0.14: 600014), USR7(239.192.0.15: 600015), USR8(239.192.0.16: 600016)			IEC 61162-450 oriented transmission group
All Settings	VD82 Tx Group To JLN-740/750 Series	Transmission Group(for HBT)	MISC(239.192.0.1: 60001), TGTD(239.192.0.2: 60002), SATD(239.192.0.3: 60003), <u>NAVD(239.192.0.4: 60004)</u> , VDRD(239.192.0.5: 60005), RCOM(239.192.0.6: 60006), TIME(239.192.0.7: 60007), PROP(239.192.0.8: 60008), USR1(239.192.0.9: 60009), USR2(239.192.0.10: 600010), USR3(239.192.0.11: 600011), USR4(239.192.0.12: 600012), USR5(239.192.0.13: 600013), USR6(239.192.0.14: 600014), USR7(239.192.0.15: 600015), USR8(239.192.0.16: 600016)			Multicast group for IEC 61162-450 reception (HBT)
		Transmission Group(for ACN)	MISC(239.192.0.1: 60001), TGTD(239.192.0.2: 60002), SATD(239.192.0.3: 60003), <u>NAVD(239.192.0.4: 60004)</u> , VDRD(239.192.0.5: 60005), RCOM(239.192.0.6: 60006), TIME(239.192.0.7: 60007), PROP(239.192.0.8: 60008), USR1(239.192.0.9: 60009), USR2(239.192.0.10: 600010), USR3(239.192.0.11: 600011), USR4(239.192.0.12: 600012), USR5(239.192.0.13: 600013), USR6(239.192.0.14: 600014), USR7(239.192.0.15: 600015), USR8(239.192.0.16: 600016)			Multicast group for IEC61162-450 reception (ACN)
		Transmission Group(for RMC)	MISC(239.192.0.1: 60001), TGTD(239.192.0.2: 60002), SATD(239.192.0.3: 60003), <u>NAVD(239.192.0.4: 60004)</u> , VDRD(239.192.0.5: 60005), RCOM(239.192.0.6: 60006), TIME(239.192.0.7: 60007), PROP(239.192.0.8: 60008), USR1(239.192.0.9: 60009), USR2(239.192.0.10: 600010), USR3(239.192.0.11: 600011), USR4(239.192.0.12: 600012), USR5(239.192.0.13: 600013), USR6(239.192.0.14: 600014), USR7(239.192.0.15: 600015), USR8(239.192.0.16: 600016)			Multicast group for IEC61162-450 reception (RMC)

Menu item	Item name	Setting name	Setting value		User settings		Description
					Current	Change	
All Settings	VD82 Tx Group To JLN-740/750 Series	Transmission Group(for ZDA)	MISC(239.192.0.1: 60001), TGTD(239.192.0.2: 60002), SATD(239.192.0.3: 60003), <u>NAVD(239.192.0.4: 60004)</u> , VDRD(239.192.0.5: 60005), RCOM(239.192.0.6: 60006), TIME(239.192.0.7: 60007), PROP(239.192.0.8: 60008), USR1(239.192.0.9: 60009), USR2(239.192.0.10: 60010), USR3(239.192.0.11: 60011), USR4(239.192.0.12: 60012), USR5(239.192.0.13: 60013), USR6(239.192.0.14: 60014), USR7(239.192.0.15: 60015), USR8(239.192.0.16: 60016)				Multicast group for IEC61162-450 reception (ZDA)
		Transmission Group(for ROT)	MISC(239.192.0.1: 60001), TGTD(239.192.0.2: 60002), SATD(239.192.0.3: 60003), <u>NAVD(239.192.0.4: 60004)</u> , VDRD(239.192.0.5: 60005), RCOM(239.192.0.6: 60006), TIME(239.192.0.7: 60007), PROP(239.192.0.8: 60008), USR1(239.192.0.9: 60009), USR2(239.192.0.10: 60010), USR3(239.192.0.11: 60011), USR4(239.192.0.12: 60012), USR5(239.192.0.13: 60013), USR6(239.192.0.14: 60014), USR7(239.192.0.15: 60015), USR8(239.192.0.16: 60016)				Multicast group for IEC61162-450 reception (ROT)
		Transmission Group(for DDC)	MISC(239.192.0.1: 60001), TGTD(239.192.0.2: 60002), SATD(239.192.0.3: 60003), <u>NAVD(239.192.0.4: 60004)</u> , VDRD(239.192.0.5: 60005), RCOM(239.192.0.6: 60006), TIME(239.192.0.7: 60007), PROP(239.192.0.8: 60008), USR1(239.192.0.9: 60009), USR2(239.192.0.10: 60010), USR3(239.192.0.11: 60011), USR4(239.192.0.12: 60012), USR5(239.192.0.13: 60013), USR6(239.192.0.14: 60014), USR7(239.192.0.15: 60015), USR8(239.192.0.16: 60016)				Multicast group for IEC61162-450 reception (DDC)
	VD83 IEC61162 error count(1/2)	First from left	0 to 128	Display only			Number of IEC 61162-450 header errors (maintenance)
		Second from left	0 to 128	Display only			Number of IEC 61162-450 tag block syntax errors (maintenance)
		Third from left	0 to 128	Display only			Number of IEC 61162-450 tag block framing errors (maintenance)

Menu item	Item name	Setting name	Setting value		User settings		Description
					Current	Change	
All Settings	VD83 IEC61162 error count(1/2)	4th from left	<u>0</u> to 128	Display only			Number of IEC 61162-450 tab block check sum errors (maintenance)
		5th from left	<u>0</u> to 128	Display only			Number of IEC 61162-450 sentence syntax errors (maintenance)
		6th from left	<u>0</u> to 128	Display only			Number of IEC 61162-450 sentence framing error (maintenance)
		7th from left	<u>0</u> to 128	Display only			Number of EC 61162-450 sentence check sum errors (maintenance)
		8th from left	<u>0</u> to 128	Display only			Number of IEC 61162-450 header errors (Main display)
		9th from left	<u>0</u> to 128	Display only			Number of IEC 61162-450 tab block errors (Main display)
	VD84 IEC61162 error count(2/2)	First from left	<u>0</u> to 128	Display only			Number of IEC 61162-450 sentence errors (Main display)
		Second from left	<u>0</u> to 128	Display only			IEC 61162-450 reception error (signal processor)
		Third from left	<u>0</u> to 128	Display only			IEC 61162-450 reception error (ROT)
		4th from left	<u>0</u> to 128	Display only			IEC 61162-450 reception error (GPS)
		5th from left	<u>0</u> to 128	Display only			IEC 61162-450 reception error (Reserved)
		6th from left	<u>0</u> to 128	Display only			IEC 61162-450 reception error (Serial dimmer)
		7th from left	<u>0</u> to 128	Display only			IEC 61162-450 reception error (Serial alert)
		8th from left	<u>0</u> to 128	Display only			IEC 61162-450 reception error (Remote display1)
	VD85 Serial Alert Configuration	Alert On Serial	Use ALF/ACN/ALC/ARC/HBT, Use ALR/ACK				Serial alert type
		"Rectified-unacknowledged" State	Not Use, Use "Rectified-unacknowledged"				Whether "Rectified – unacknowledged" state is used by ALR or not
	VD90 Mode Status	Mode:	M,B,E,U,W,L,R	Display only			Mode flag
	VD99 Equipment Power Status	Running:	ON, OFF, STBY	Display only			Running status
		Has Notification:	Disabled : Red Enabled : Green	Display only			OFF/STBY notification function available/unavailable
	Demo	(VD17) Demonstration	Pattern(1 to 99)	<u>1</u> to 99			Demo pattern
Speed [kn]			-100.00 to <u>0.00</u> to 100.00			Demo vessel speed	
Rate of Turn [deg/min]			-360.00 to <u>0.00</u> to 360.00			Demo rate of tern	
Software Version	NWZ-510 or NWZ-4640		Display only			Main display version information	
	NQA-7040		Display only			Distribution processor version information	
	NJC-70S or NJC-70D		Display only			Signal processor version information	
	NKF-547		Display only			Transducer version information	
	CDF-7400		Display only			Signal processor I/F circuit version information	
	CDC-7400(1,CPU)		Display only			Signal processor circuit (1, CPU) version information	
	CDC-7400(1,FPGA)		Display only			Signal processor circuit (1, FPGA) version information	
	CMN-7400(1)		Display only			Signal processor circuit (1) version information	
	CDC-7400(2,CPU)		Display only			Signal processor circuit (2, CPU) version information	
	CDC-7400(2,FPGA)		Display only			Signal processor circuit (2, FPGA) version information	
	CMN-7400(2)		Display only			Signal processor transmission/reception circuit (2) version information	
	CBD-7400		Display only			Signal processor power supply circuit version information	
	CQD-7040		Display only			Distribution processor terminal board version information	
	NWZ-650(1)		Display only			Remote displayNWZ-650SDR version information (1)	
	NWZ-650(2)		Display only			Remote displayNWZ-650SDR version information (2)	
	NWZ-840(1)		Display only			Remote displayNWZ-840SDR version information (1)	
NWZ-840(2)		Display only			Remote displayNWZ-840SDR version information (2)		

● JLN-741A, JLN-741N

Set value of the underline is the value of the factory.

Menu item	Item name	Setting name	Setting value		User settings		Description
					Current	Change	
First Settings	VD4 Start Measure	Measure	Started, <u>Stopped</u>				Start of transmission
	VD6 Speed Calculation Configuration	Speed Correlation	-50.0 to <u>0.0</u> to 50.0				Correction of ship speed
	VD10 Distance Reset	Total Distance	<u>0</u> to 999999.99				Setting of total distance
	VD14 Depth Configuration	Draft [m]	-100.0 to <u>0.0</u> to +100.0				Draft
	VD35 Transducer Mounting(NKF-547) Information	Model Name	UP to 9 ASCII characters				Model name (NKF-547/531E)
		Serial Number	Up to 10 ASCII characters				Serial number (NKF-547/531E)
		Barcode Number	Up to 13 ASCII characters				Bar code number (NKF-547/531E)
VD36 Signal Processor(NJC-70S/D) Errors	No Bubble Reference	Normal : Green Abnormal : Red	Display only			Bubble detection reference abnormality	
All Settings	VD3 Signal Processor(NJC-70S/D) Status	[d]	<u>0</u> to 9999	Display only			Total operation time (Main display-Day)
		[h]	<u>0</u> to 23	Display only			Total operation time (Main display-hour)
		[m]	<u>0</u> to 59	Display only			Total operation time (Main display-minute)
		[degC]	Display only				Frame temperature (signal processor)
		[Volt]	Display only				Power supply voltage (48V)
		[Volt]	Display only				Power supply voltage (5V-Ch1)
		[Volt]	Display only				Power supply voltage (5V-Ch2)
		RAM Error	Normal : Green Abnormal : Red	Display only			RAM abnormality (control CPU)
		ROM Error	Normal : Green Abnormal : Red	Display only			ROM abnormality (control CPU)
	EEPROM Error	Normal : Green Abnormal : Red	Display only			EEPROM abnormality (control CPU)	
	VD4 Start Measure	Measure	Started, <u>Stopped</u>				Start of transmission
	VD6 Speed Calculation Configuration	Speed Correlation	-50.0 to <u>0.0</u> to 50.0				Correction of vessel speed
	VD9 Alert Status	Integrated Alert	Normal : Green Abnormal : Red	Display only			Integrated alert flag
		Lost Speed	Normal : Green Abnormal : Red	Display only			Lost speed alert (fore/after)
		Over Speed	Normal : Green Abnormal : Red	Display only			Fore/after vessel speed notice (upper limit)
		Low Speed	Normal : Green Abnormal : Red	Display only			Fore/after vessel speed notice (lower limit)
		Bubble Detected	Normal : Green Abnormal : Red	Display only			Bubble detection
		Software Updated	Normal : Green Abnormal : Red	Display only			Software updated
		Maintenance Mode	Normal : Green Abnormal : Red	Display only			Maintenance mode
Reboot Required		Normal : Green Abnormal : Red	Display only			Reboot required	
VD3 Alert		Normal : Green Abnormal : Red	Display only			PJRCM,VD,3 integrated alert	
VD36 Alert	Normal : Green Abnormal : Red	Display only			PJRCM,VD,36 integrated alert		
VD10 Distance Reset	Total Distance	<u>0</u> to 999999.99				Setting of total distance	
VD13 Transducer Angle Configuration	[deg]	-180.0 to <u>0.0</u> to 180.0				Transducer angle correction (fore/after: Yaw)	
	[deg]	-180.0 to <u>0.0</u> to 180.0				Transducer angle correction (fore/after: Pitch)	
	[deg]	-180.0 to <u>0.0</u> to 180.0				Transducer angle correction (Port/starboard: Yaw)	
	[deg]	-180.0 to <u>0.0</u> to 180.0				Transducer angle correction (Port/starboard: Roll)	
VD14 Depth Configuration	Draft [m]	-100.0 to <u>0.0</u> to +100.0				Draft	
VD18 System Test Status	TEST 18kn	Enabled : Red Disabled : Green				System test (18km test)	
	LOST SPEED	Enabled : Red Disabled : Green				System test (Lost speed alert)	
VD19 Power Detect Value	Ch1:	0 to 4096	Display only			Travelling wave (Ch1: Fore direction)	

APPA

Menu item	Item name	Setting name	Setting value	User settings	Description
-----------	-----------	--------------	---------------	---------------	-------------

					Current	Change	
All Settings	VD19 Power Detect Value	Ch2:	0 to 4096	Display only			Travelling wave (Ch2: After direction)
		Ch3:	0 to 4096	Display only			Travelling wave (Ch3: Starboard direction)
		Ch4:	0 to 4096	Display only			Travelling wave (Ch4: Port direction)
	VD27 Support Frequency Configuration	NJC-70:	2.0,---	Display only			Supported frequency (NJC-70S/D)
		CDC-7400(1):	2.0,---	Display only			Supported frequency (CDC-7400 (1))
		CDC-7400(2):	2.0,---	Display only			Supported frequency (CDC-7400 (2))
		CMN-7400(1):	2.0,---	Display only			Supported frequency (CMN-7400 (1))
		CMN-7400(2):	2.0,---	Display only			Supported frequency (CMN-7400 (2))
	VD35 Transducer Mounting(NKF-547) Information	Model Name	Up to 9 ASCII characters				Model name (NKF-547/531E)
		Serial Number	Up to 10 ASCII characters				Serial number (NKF-547/531E)
		Barcode Number	Up to 13 ASCII characters				Bar code number (NKF-547/531E)
	VD36 Signal Processor(NJC-70S/D) Errors	No Bubble Reference	Normal : Green Abnormal : Red	Display only			Bubble detection reference abnormality
		Power Fail(1)	Normal : Green Abnormal : Red	Display only			Transmission power fail (1 axis)
		Power Fail(2)	Normal : Green Abnormal : Red	Display only			Transmission power fail (2 axes)
		PA Error(1)	Normal : Green Abnormal : Red	Display only			PA1 error
		PA Error(2)	Normal : Green Abnormal : Red	Display only			PA2 error
		PA Error(3)	Normal : Green Abnormal : Red	Display only			PA3 error
		PA Error(4)	Normal : Green Abnormal : Red	Display only			PA4 error
		RSLT Error(1)	Normal : Green Abnormal : Red	Display only			RSLT1 error
		RSLT Error(2)	Normal : Green Abnormal : Red	Display only			RSLT2 error
		RSLT Error(3)	Normal : Green Abnormal : Red	Display only			RSLT3 error
		RSLT Error(4)	Normal : Green Abnormal : Red	Display only			RSLT4 error
		Frequency Measure Error	Normal : Green Abnormal : Red	Display only			Frequency detection abnormality (Ch1)
		Frequency Measure Error	Normal : Green Abnormal : Red	Display only			Frequency detection abnormality (Ch2)
		Frequency Measure Error	Normal : Green Abnormal : Red	Display only			Frequency detection abnormality (Ch3)
		Frequency Measure Error	Normal : Green Abnormal : Red	Display only			Frequency detection abnormality (Ch4)
		FPGA Configuration Fail	Normal : Green Abnormal : Red	Display only			FPGA configuration abnormality (1 axis)
		FPGA Configuration Fail	Normal : Green Abnormal : Red	Display only			FPGA configuration abnormality (2 axes)
		Supported Frequency	Normal : Green Abnormal : Red	Display only			Supported frequency abnormality
		High Temperature	Normal : Green Abnormal : Red	Display only			Signal processor temperature abnormality
		Voltage Error(48V)	Normal : Green Abnormal : Red	Display only			Voltage abnormality (signal processor 48V)
		Voltage Error(5V-1)	Normal : Green Abnormal : Red	Display only			Voltage abnormality (signal processor 5V-Ch1)
		Voltage Error(5V-2)	Normal : Green Abnormal : Red	Display only			Voltage abnormality (signal processor 5V-Ch2)
		Software Version	Normal : Green Abnormal : Red	Display only			Software version abnormality (computation CPU1)
		Software Version	Normal : Green Abnormal : Red	Display only			Software version abnormality (computation CPU2)
		Software Version	Normal : Green Abnormal : Red	Display only			Software version abnormality (computation CPU3)
		Software Version	Normal : Green Abnormal : Red	Display only			Software version abnormality (computation CPU4)
	Software Version	Normal : Green Abnormal : Red	Display only			Software version abnormality (computation (FPGA1))	
	Software Version	Normal : Green Abnormal : Red	Display only			Software version abnormality (computation (FPGA2))	

Menu item	Item name	Setting name	Setting value		User settings		Description
					Current	Change	
All Settings	VD59 Channel Enable Flag	Channel 1	Disable,Enabled				Channel 1 valid flag
		Channel 2	Disable,Enabled				Channel 2 valid flag
		Channel 3	Disable,Enabled				Channel 3 valid flag
		Channel 4	Disable,Enabled				Channel 4 valid flag
	VD90 Mode Status	Mode:	<u>M</u> ,B,E,U,W,L,R	Display only			Mode flag
Demo	(VD17) Demonstration	Pattern(1 to 99)	<u>1</u> to 99				Demo pattern
		Speed [kn]	-100.00 to <u>0.00</u> to 100.00				Demo vessel speed
		Rate of Turn [deg/min]	-360.00 to <u>0.00</u> to 360.00				Demo rate of tern
Software Version	NJC-70S or NJC-70D		Display only				Signal processor version information
	NKF-547		Display only				Transducer version information
	CDF-7400		Display only				Signal processor I/F circuit version information
	CDC-7400(1,CPU)		Display only				Signal processor circuit (1, CPU) version information
	CDC-7400(1,FPGA)		Display only				Signal processor circuit (1, FPGA) version information
	CMN-7400(1)		Display only				Signal processor circuit (1) version information
	CDC-7400(2,CPU)		Display only				Signal processor circuit (2, CPU) version information
	CDC-7400(2,FPGA)		Display only				Signal processor circuit (2, FPGA) version information
	CMN-7400(2)		Display only				Signal processor transmission/reception circuit (2) version information
	CBD-7400		Display only				Signal processor power supply circuit version information



(This page intentionally left blank)

Appendix B Installation Drawings

Signal Processor NJC-70S

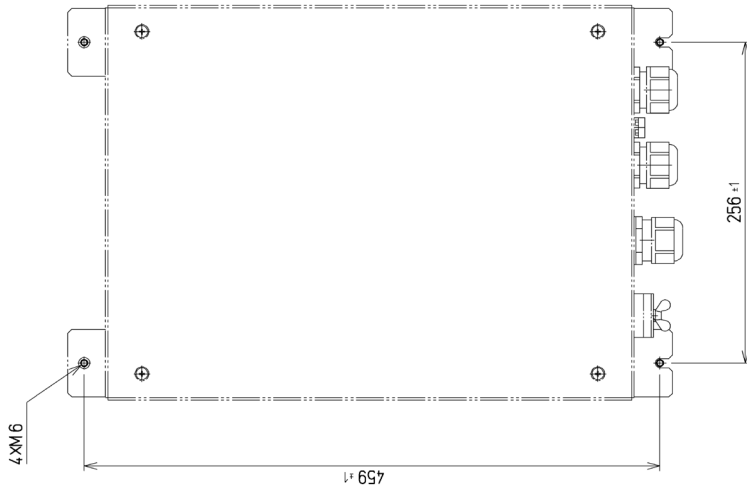

取付寸法
MOUNTING HOLE



塗装色: 黒 (N2.5)
質量: 5.5 kg
単位: mm

COLOR: BLACK (N2.5)
MASS: 5.5 kg
UNIT: mm

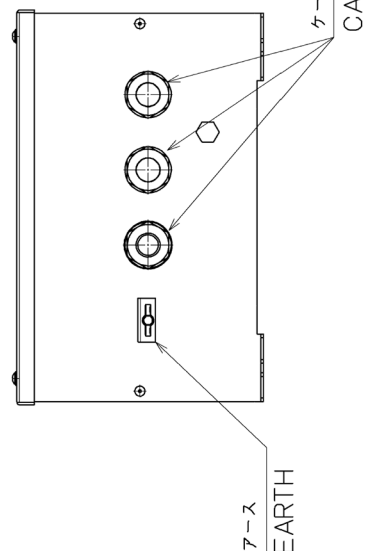
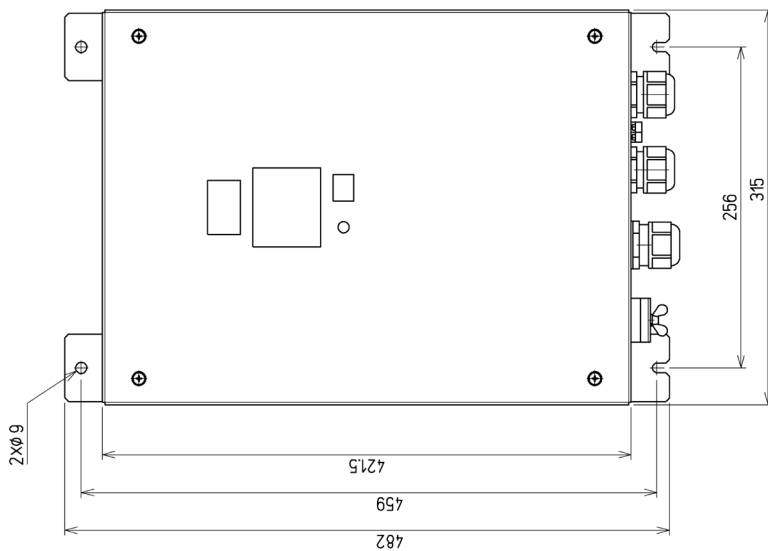

Transducer Mounting NKF-547

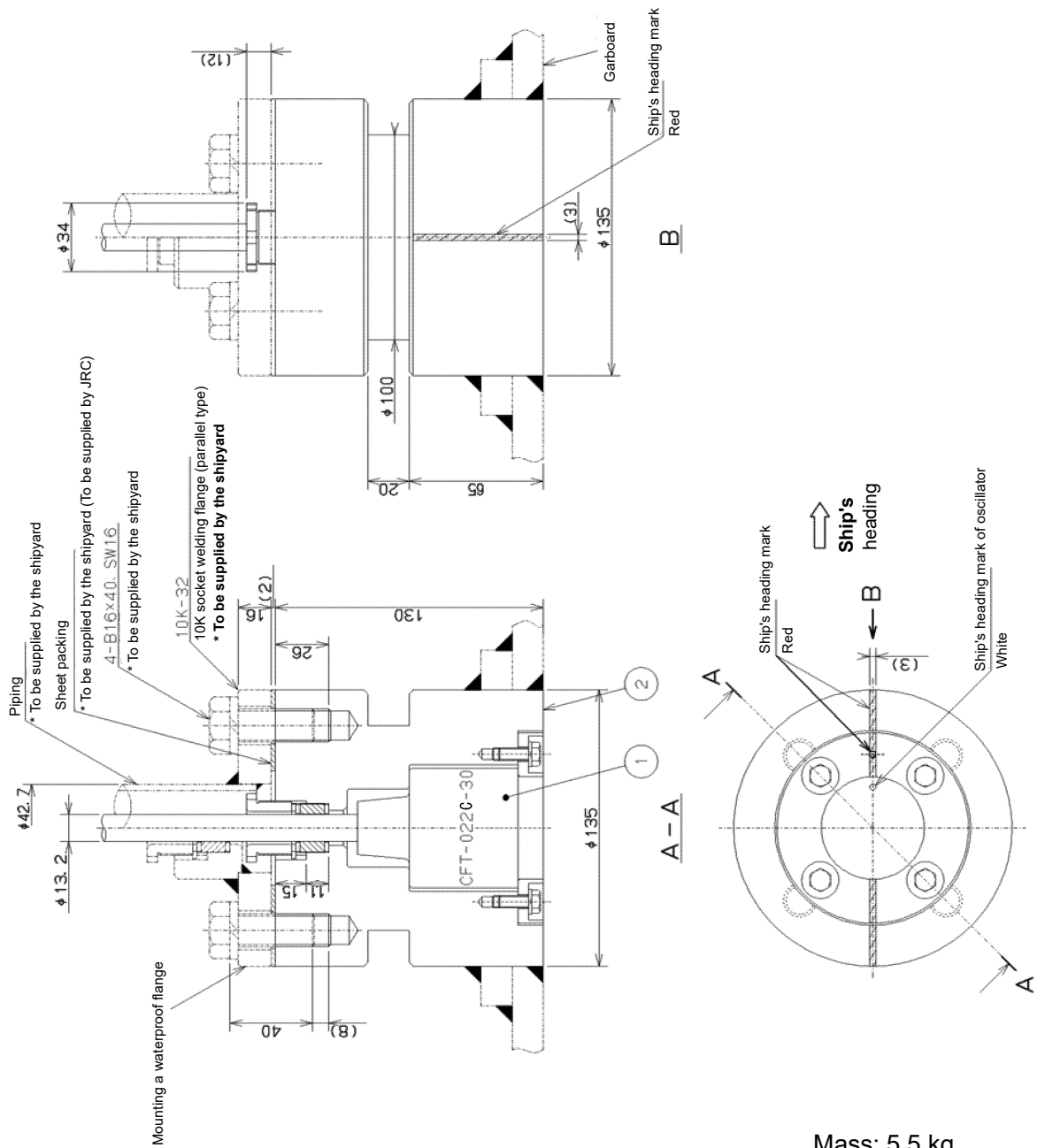

Mass: 5.5 kg

AC power rectifier NBA-5143

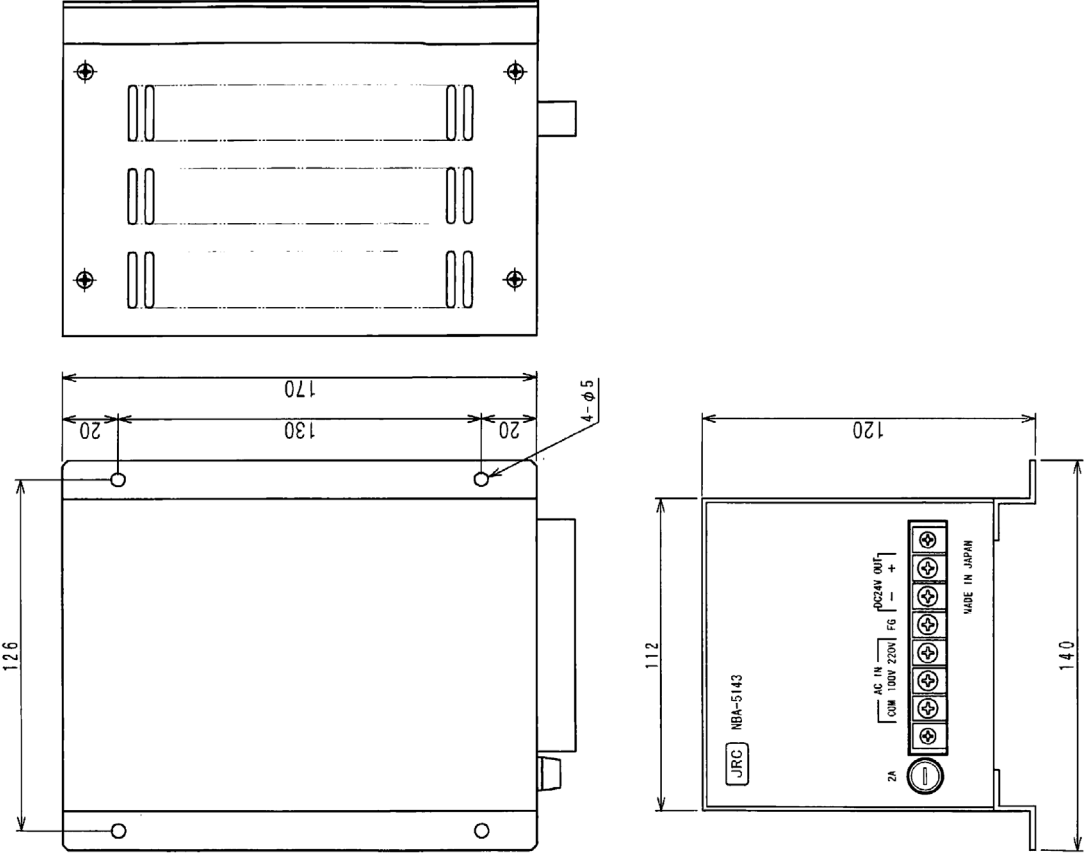

Mass: 3.5kg

Distribution Processor NQA-7040

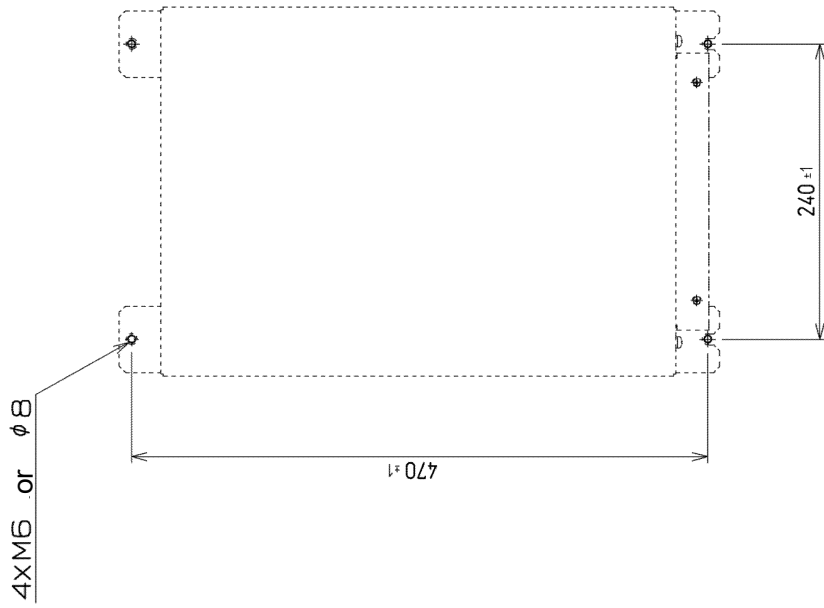

Mounting hole size diagram

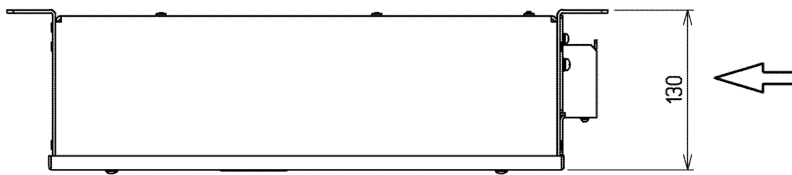

Cable inlet

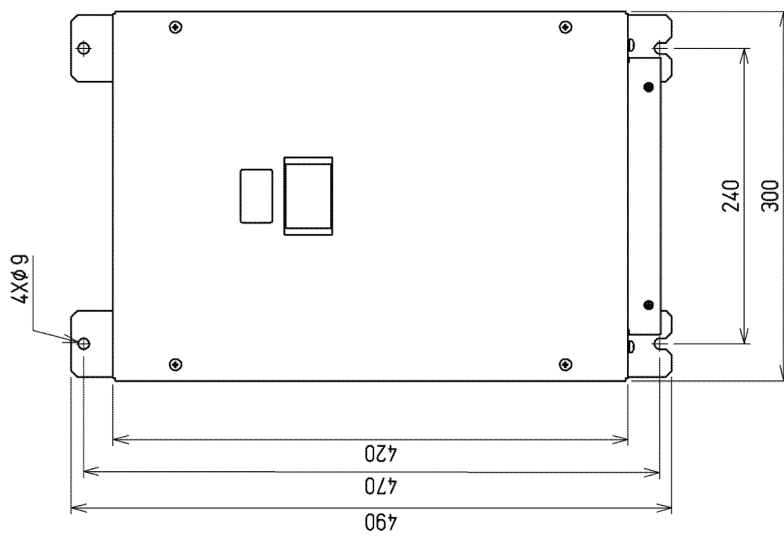

Mass: 6.0 kg

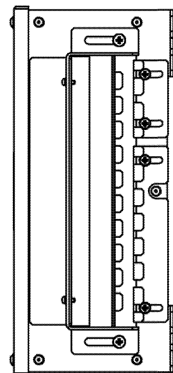

JLN-740A/741A Main Display NWZ-510SDW

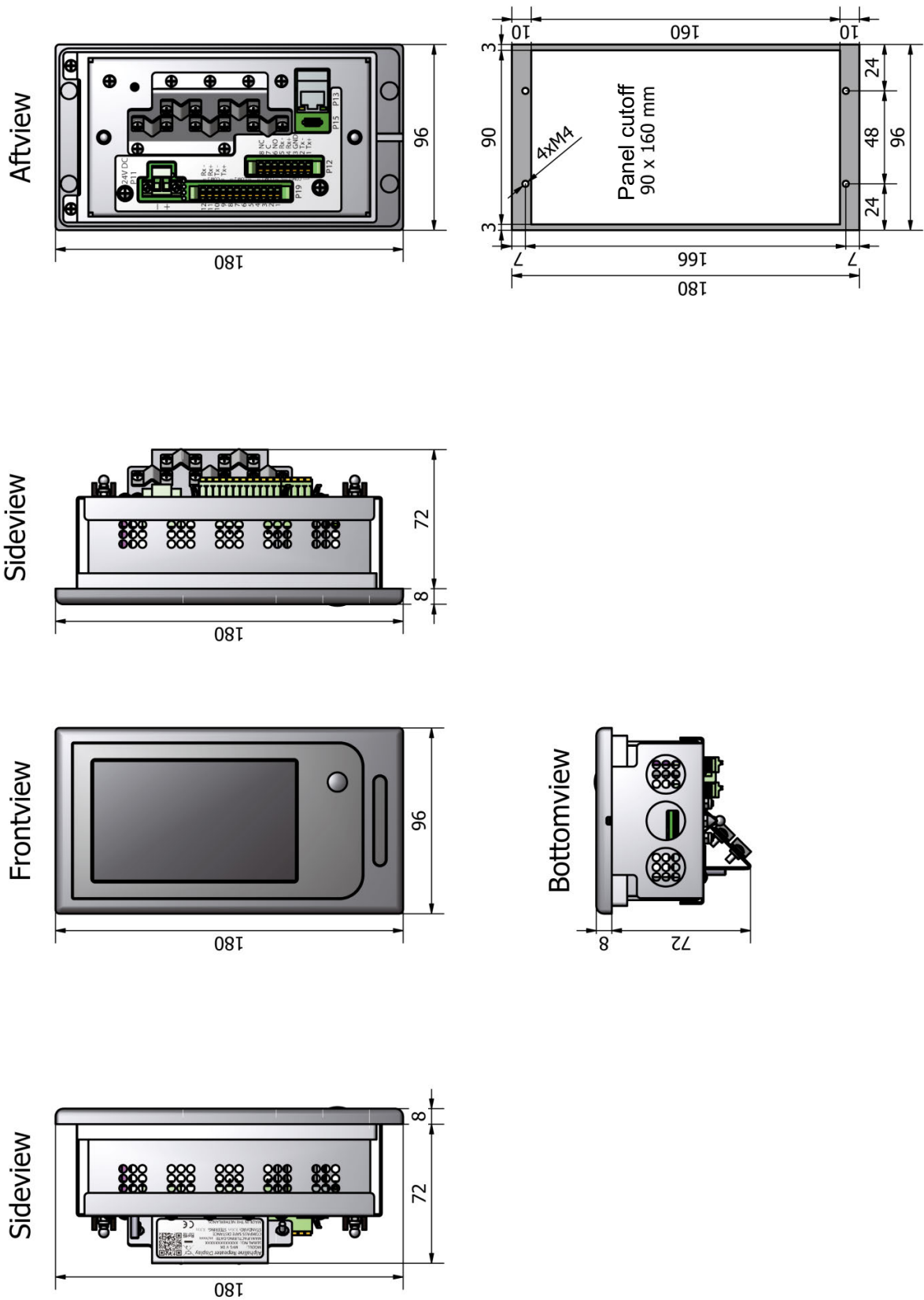

Mass: 1.2 kg

JLN-740N/741N Main Display NWZ-4640

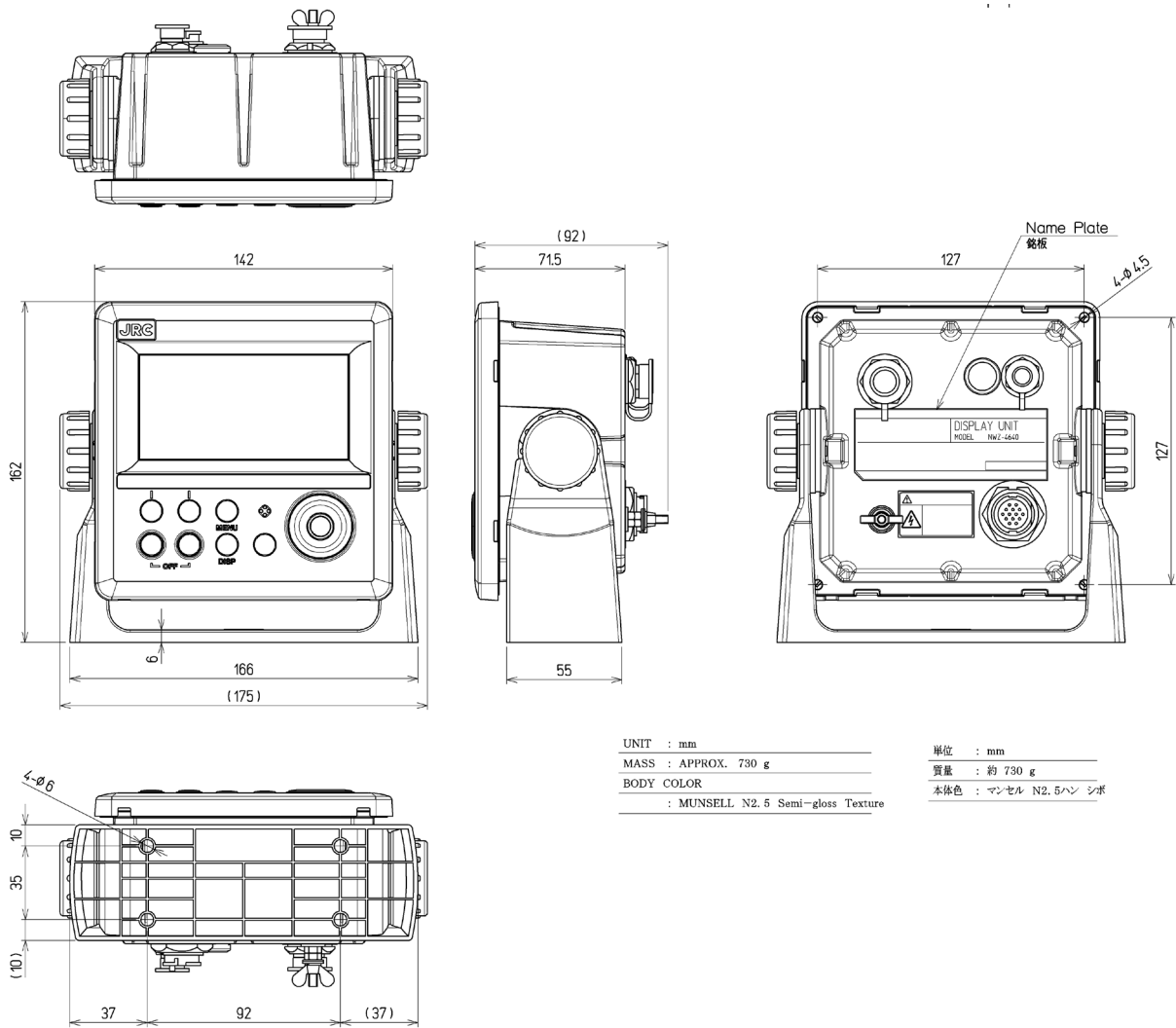

Remote Display NWZ-650SDR (Optional)

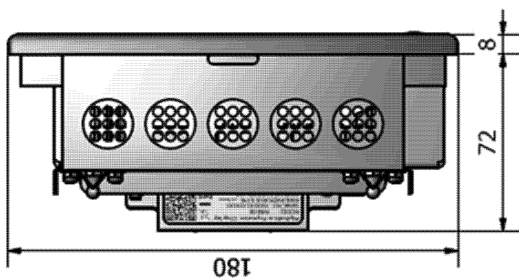
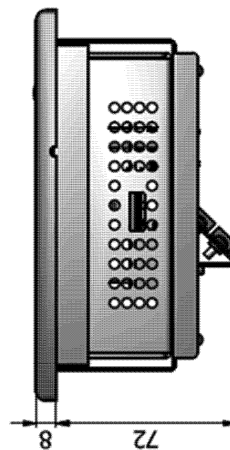
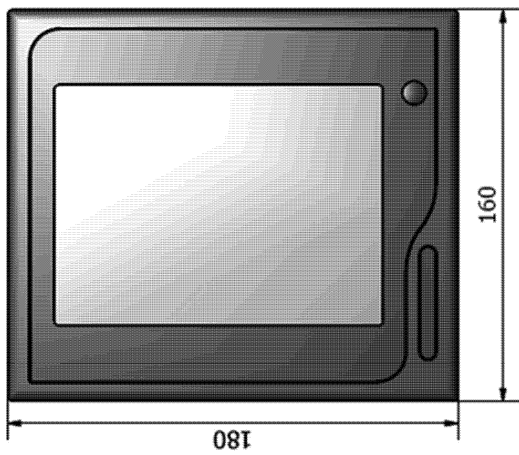
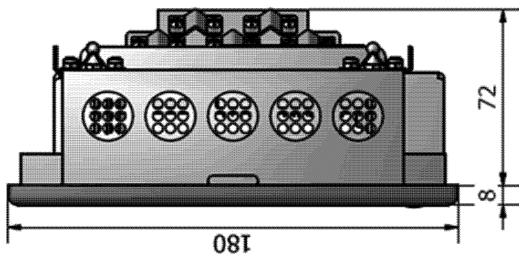
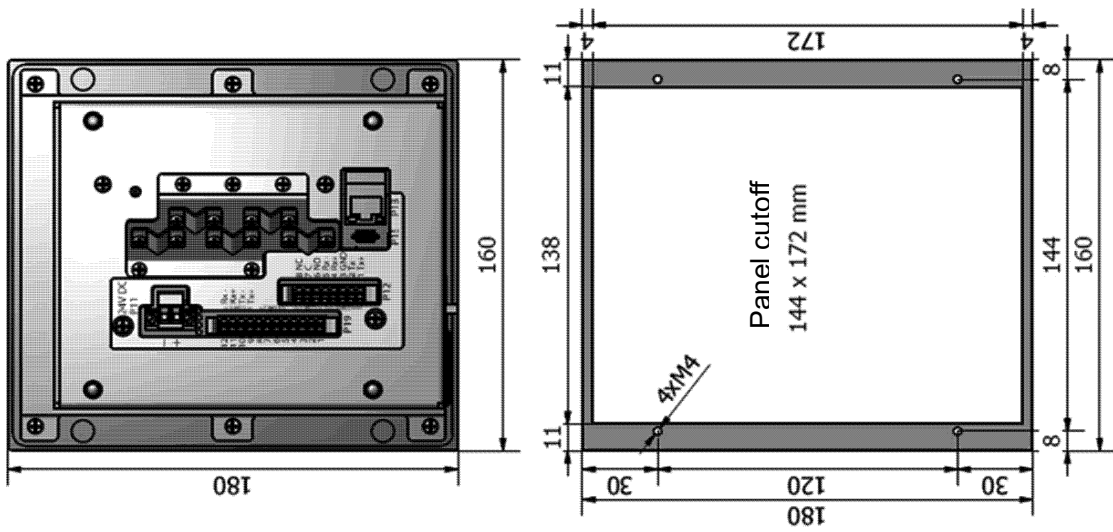

Mass: 1.4 kg

APP B

Remote Display NWZ-840SDR (Optional)

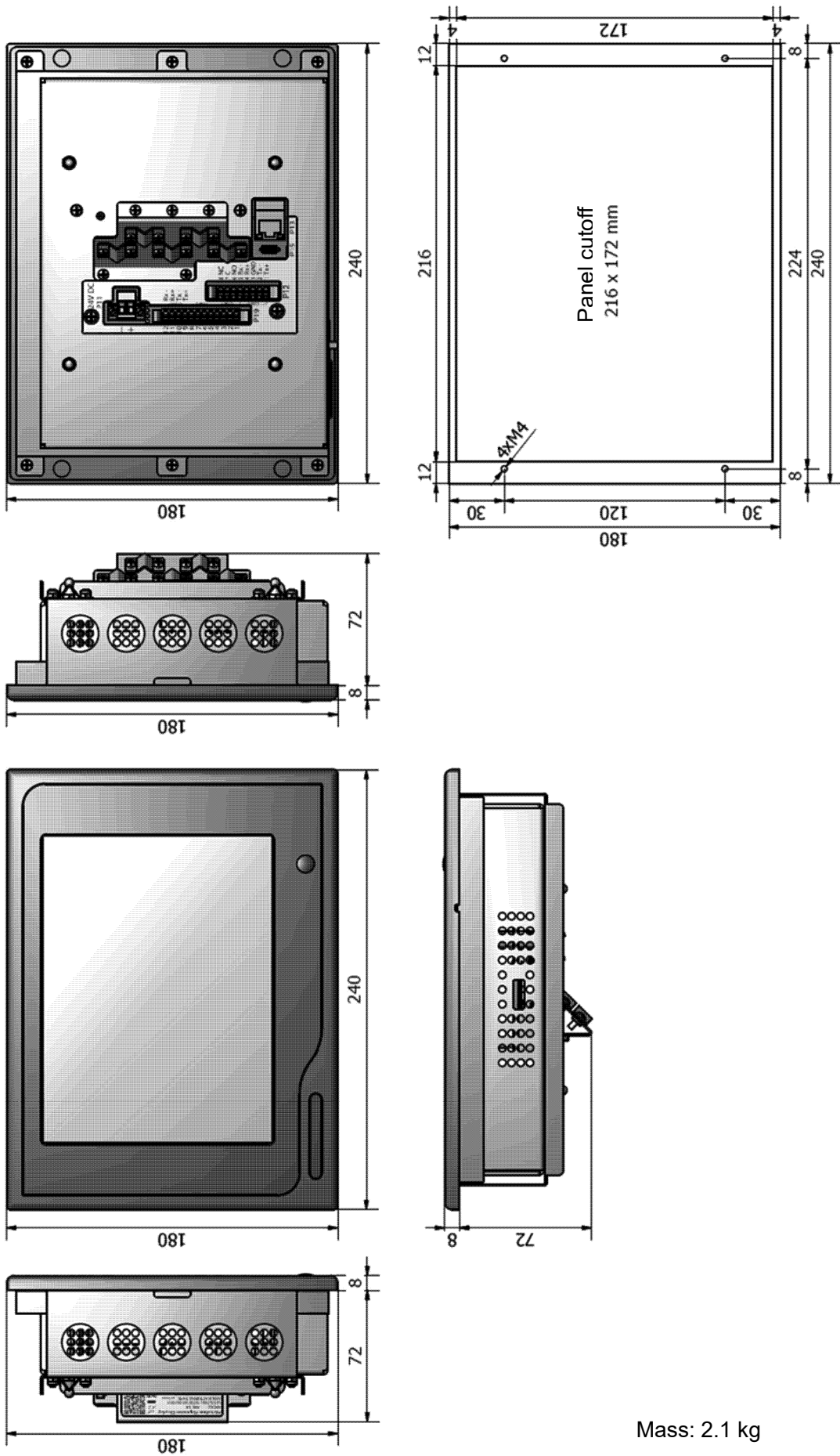

Mass: 2.1 kg

MID NWZ-4610 (Optional)

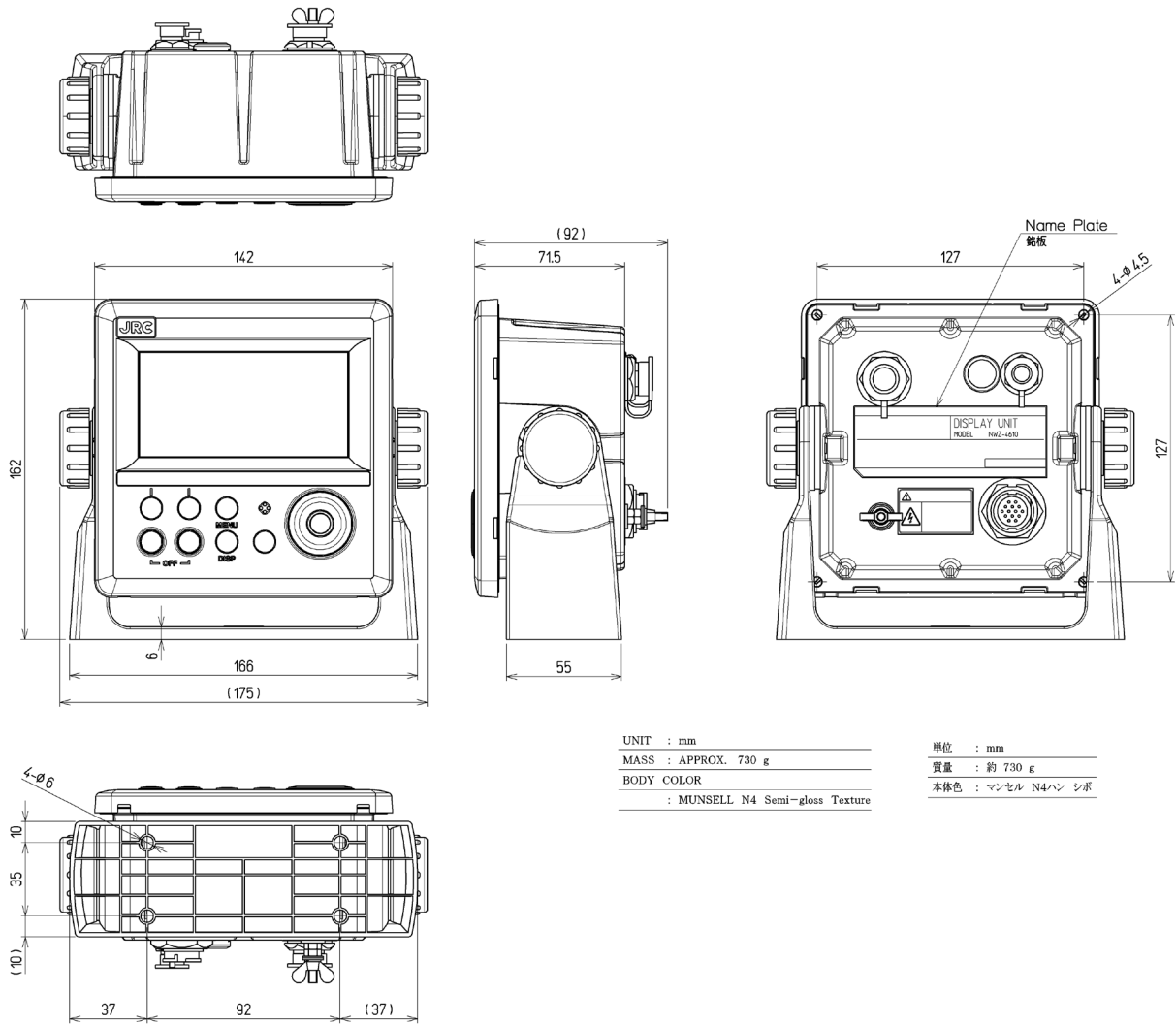

UNIT : mm
 MASS : APPROX. 730 g
 BODY COLOR : MUNSELL N4 Semi-gloss Texture

単位 : mm
 質量 : 約 730 g
 本体色 : マンセル N4ハン シボ

Distance Counter NWW-7 (Optional)

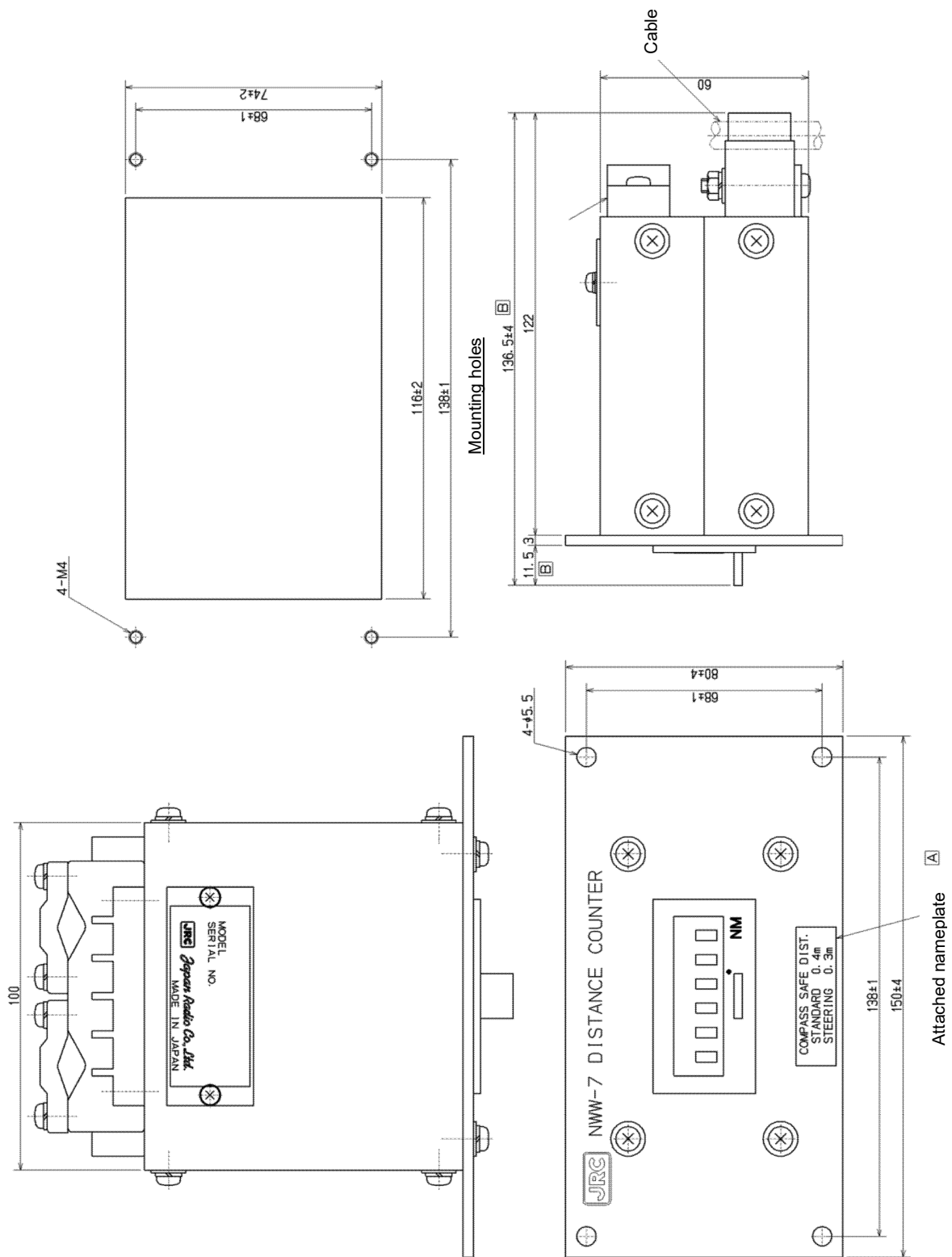

Mass: 1.0 kg

Analog Display NWW-24 (Optional)

Standard tolerance

Classification	Outline dimensions
30 or less	±1
More than 30 and up to 120	±1.5
More than 120 and up to 400	±2.5
More than 400 and up to 1000	±4
More than 1000 and up to 2000	±6
More than 2000 and up to 3000	±8

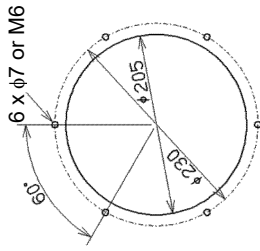

NWW-24L Mounting holes
(Scale 1/5)

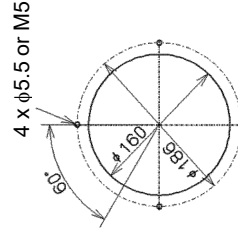

NWW-24S Mounting holes
(Scale 1/5)

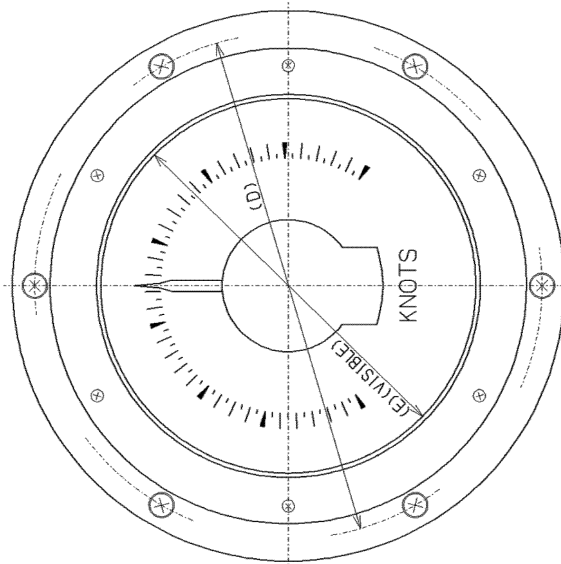
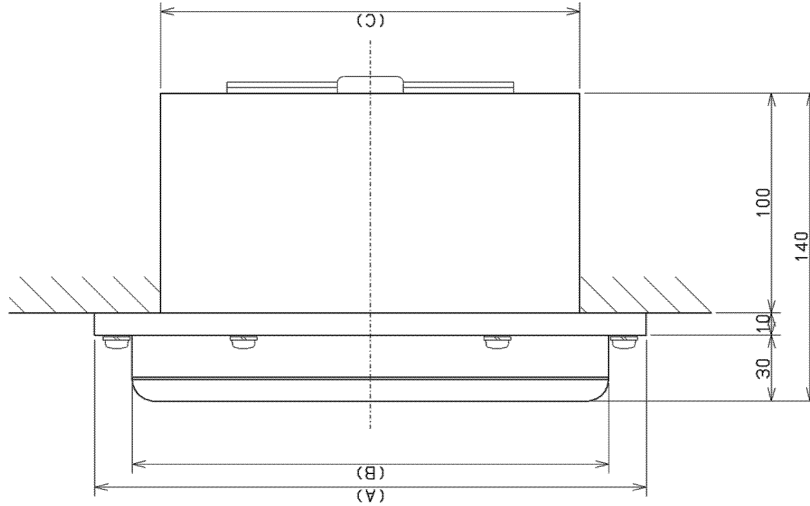

Model	A	B	C	D	E	Mass.	Scale	E. L. plate
NWW-24L	φ250	φ216	φ190	φ230	φ170	6.5 kg	-4~20 -5~25	Green
NWW-24S	φ200	φ173	φ150	φ186	φ125	3 kg	-6~30 -7~35 -8~40	Orange

Model Scale plate
NWW-24
 (L) (20) (6)
 (S) (25) (0)
 (30)
 (35)
 (40)

Painting color

Analog Display NWW-25 (Optional)

Outline dimensions		Permissible dimensional deviations
Over	To	
3	6	±0.5
6	30	±1
30	120	±1.5
120	400	±2.5
400	1000	±4
1000	2000	±6
2000	4000	±8

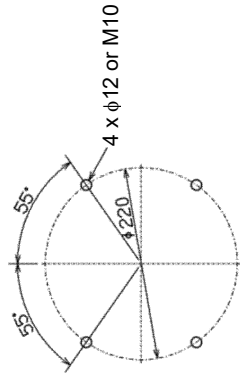
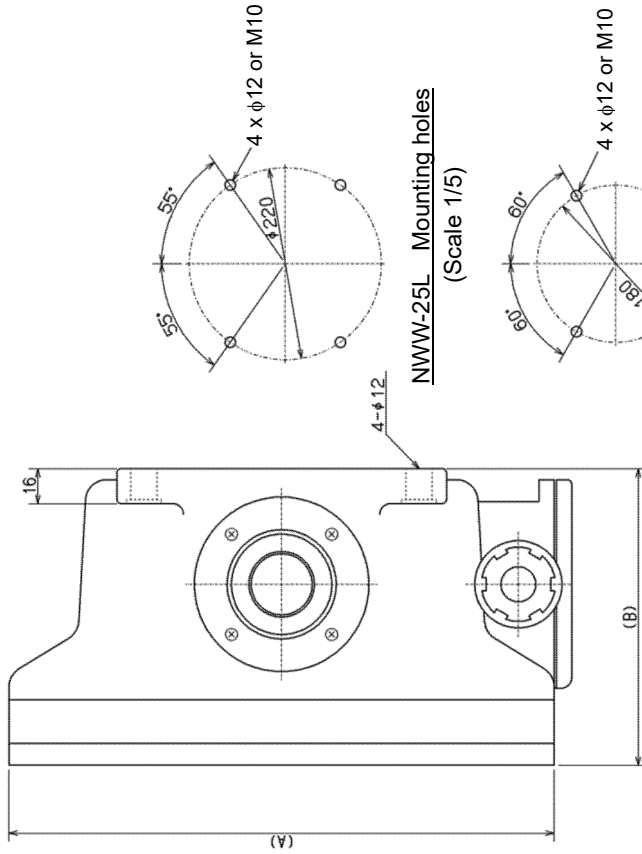
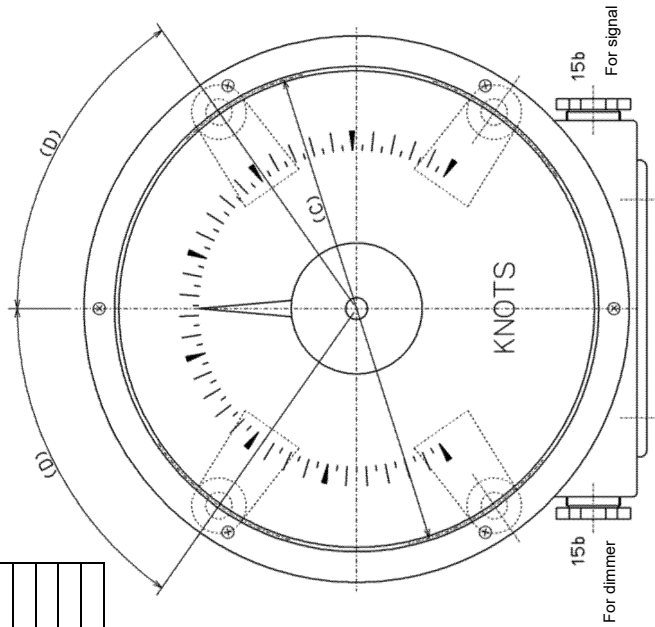

NWW-25L Mounting holes
(Scale 1/5)

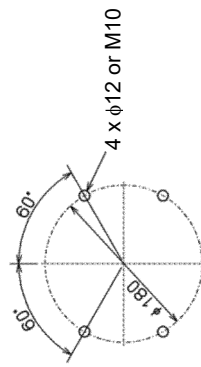

NWW-25S Mounting holes
(Scale 1/5)

Model	A	B	C	D	Mass.	Scale	E. L. plate
NWW-25L	φ250	136	φ220	55°	7kg	-4~20 -5~25 -6~30	Green
NWW-25S	φ200	140	φ180	60°	5kg	-7~35 -8~40 -10~20	Orange

Painting color

Model Scale E. L. plate
 NWW-25
 (L) (20) (G)
 (S) (25) (O)
 (30) (35)
 (40)

Analog Display NWW-26 (Optional)

Outline dimensions		Permissible dimensional deviations
Over	To	
3	6	±0.5
6	30	±1
30	120	±1.5
120	400	±2.5
400	1000	±4
1000	2000	±6
2000	4000	±8

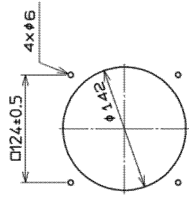
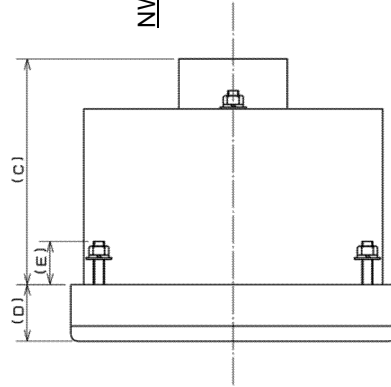
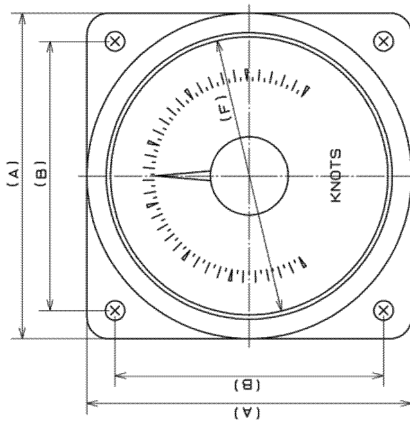

NWW-26L Mounting holes
(Scale 1/5)

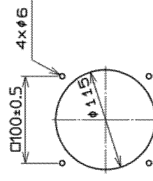

NWW-26M Mounting holes
(Scale 1/5)

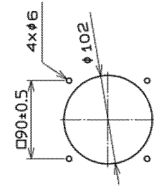

NWW-26S Mounting holes
(Scale 1/5)

Model	A	B	C	D	E	F	Mass	Scale	E. L. plate
NWW-26L	150	124	105	26	20	φ 128	2.5 kg	-4~20	Green
								-5~25	
NWW-26M	120	100	90	23	15	φ 100	1.5 kg	-6~30	Orange
								-7~35	
NWW-26S	110	90	90	11	15	φ 100	1 kg	-8~40	Orange

Model Scale plate
 Painting color

Model Scale plate
 (L) (20) (G)
 (M) (25) (O)
 (S) (30) (35)
 (40)

NWW-26

Junction Box CQD-10 (Optional)

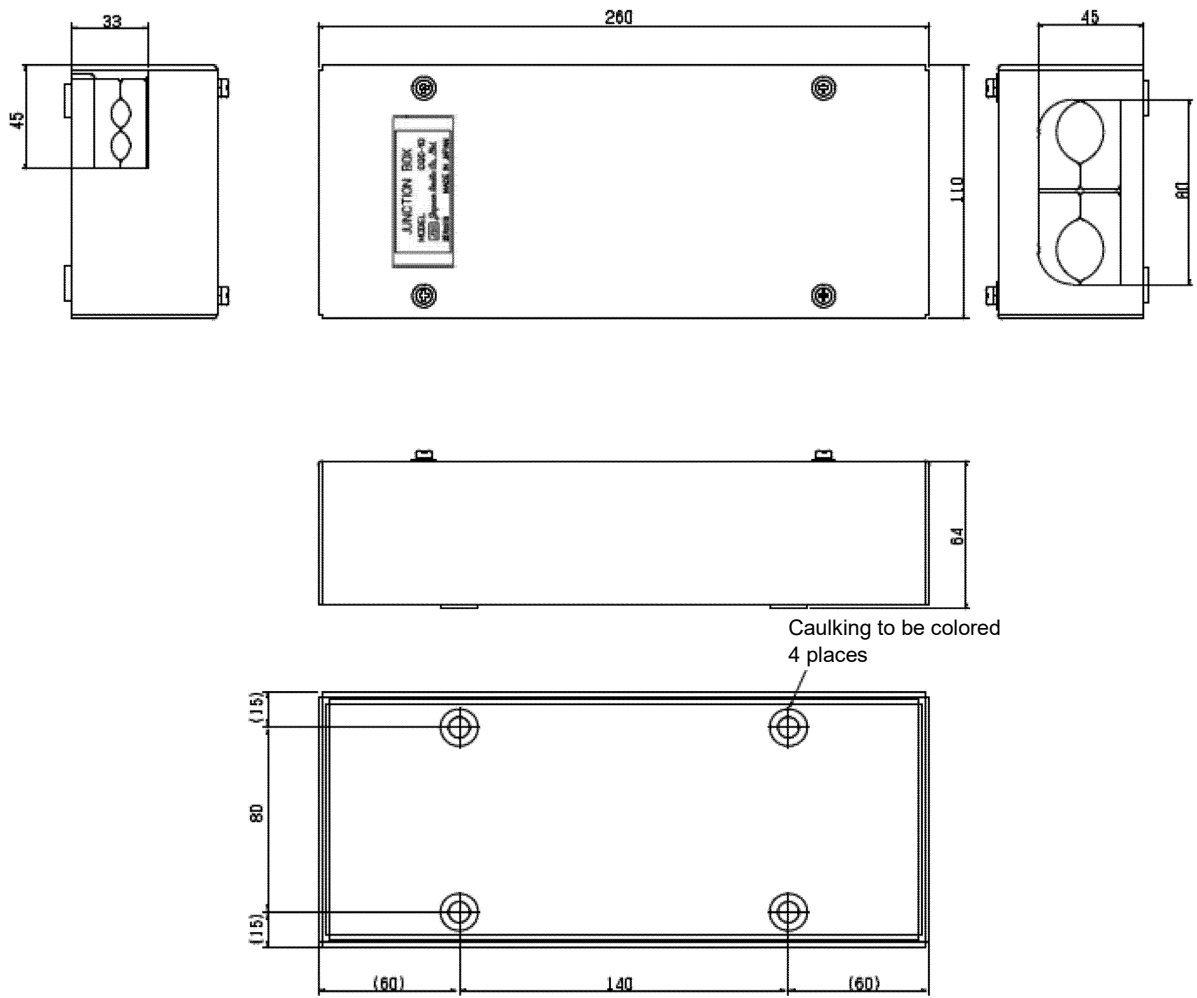

Mass: 1.1 kg

Dimmer Unit NCM-227 (Optional)

Outline dimensions		Permissible dimensional deviations
Over	To	
3	6	±0.5
6	30	±1
30	120	±1.5
120	400	±2.5
400	1000	±4
1000	2000	±6
2000	4000	±8

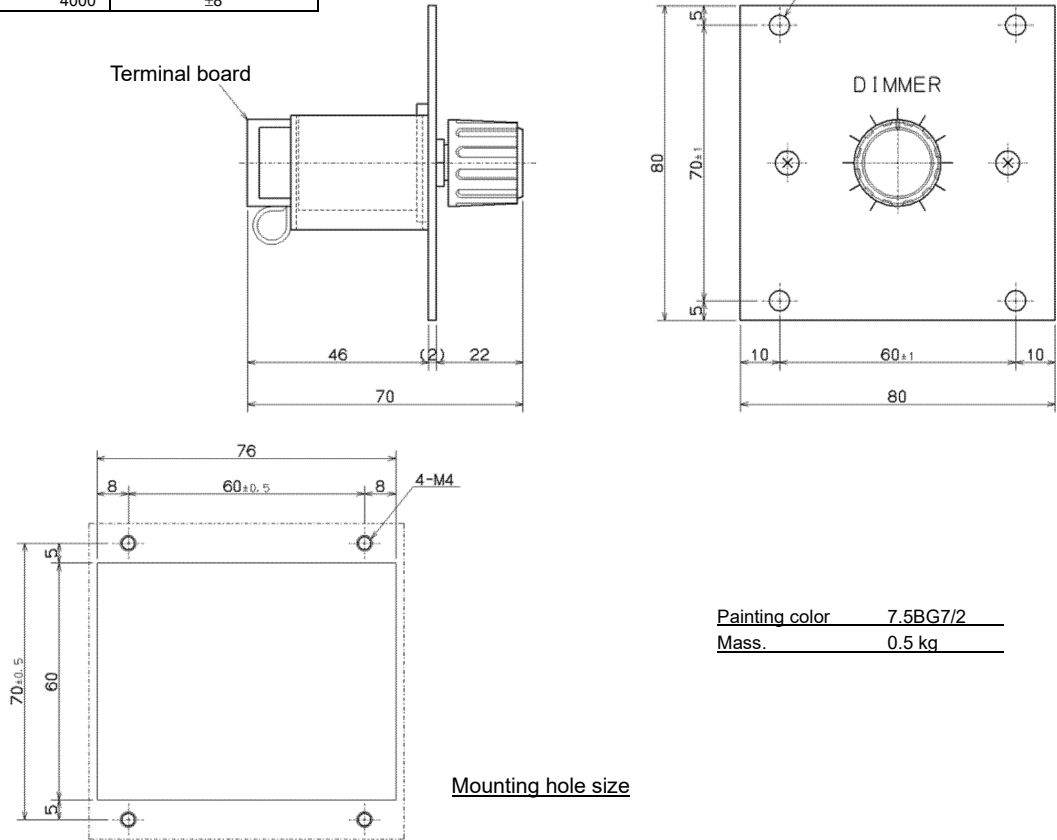

Dimmer Unit NCM-329 (Optional)

Outline dimensions		Permissible dimensional deviations
Over	To	
3	6	± 0.5
6	30	± 1
30	120	± 1.5
120	400	± 2.5
400	1000	± 4
1000	2000	± 6
2000	4000	± 8

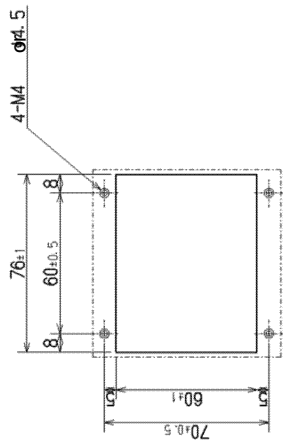

Mounting hole size diagram
Scale 1:2

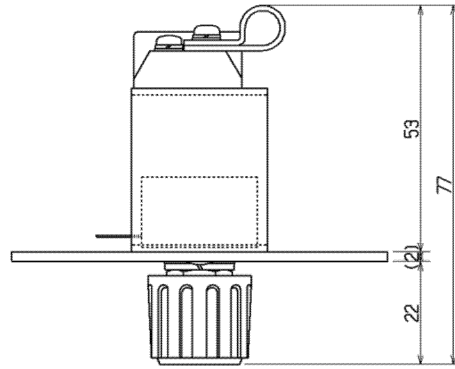
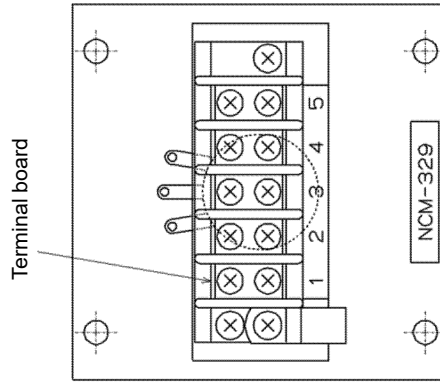
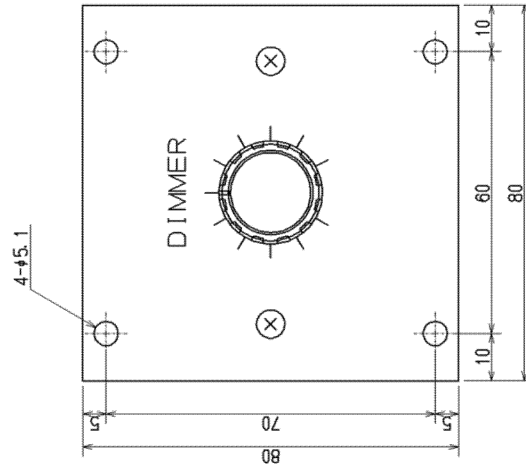

Painting color 7.5BG7/2
Mass 0.5 kg

Transducer Mounting NKF-531E (Option)

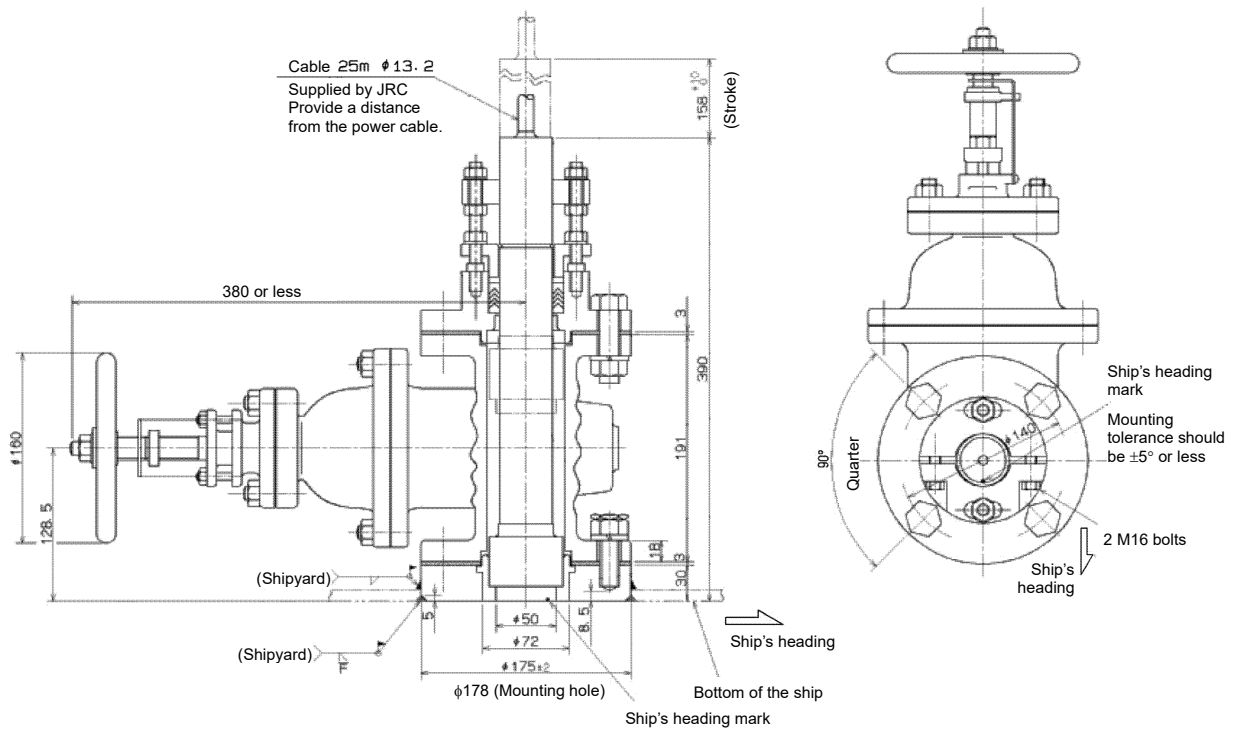

Mass: 48 kg

(This page intentionally left blank)

Appendix C

Error due to the deviation from the irradiation angle reference value

The causes of occurrence of deviation from the reference value are classified into two: hull motions, and manufacturing or installation of the oscillator. In general, in Doppler log, to minimize the errors caused by various hull motions, symmetrical sequence (dual beam) is often applied as shown in Figure 1 a).

The following section discusses the tolerance values by comparing the dual beam system with the single beam system.

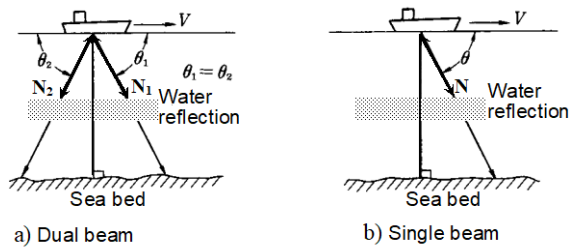

Figure 1 Doppler effect

C.1 Errors by hull motions

Figure 4 shows the speed errors that are caused by the deviation angle of rolling and pitching. This condition is explained below.

1 Vertical speed component

Although a speed component in the horizontal direction is the only important factor for a ship, a vertical speed component occurs due to a cause such as ocean swell, causing an error. See Figure 2. Doppler shift frequency f_{d1} for beam N_1 will be as follows when the horizontal speed component is V and the vertical speed component is U .

$$f_{d1} = \frac{2f_0}{C} (V \cos \theta_1 - U \sin \theta_1) \quad (1)$$

In the same way, Doppler shift frequency f_{d2} for beam N_2 will be:

$$f_{d2} = \frac{2f_0}{C} (-V \cos \theta_2 - U \sin \theta_2) \quad (2)$$

When $\theta_1 = \theta_2$, the following expression is established for dual beam:

$$f_d = f_{d1} - f_{d2} = \frac{4f_0 V}{C} \cos \theta_1 \quad (3)$$

As a result, vertical components are canceled out, not impacting the Doppler shift frequency and a Doppler shift frequency twice that of the single beam system is obtained.

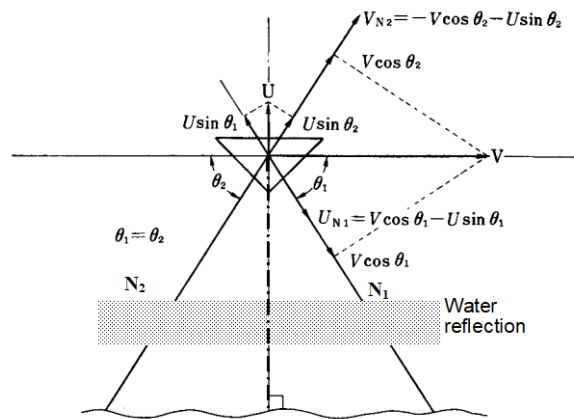

Figure 2 Impact of vertical speed component

2 Trim and heel

When there is a leaning of δ to the vertical line as shown in Figure 3, the Doppler shift frequency that occurs to each of beam N_1 and beam N_2 is as follows:

$$f_{d1} = \frac{2Vf_0}{C} (\cos \theta \cos \delta - \sin \theta \sin \delta)$$

$$f_{d2} = \frac{2Vf_0}{C} (\cos \theta \cos \delta + \sin \theta \sin \delta)$$

The error in the dual beams is:

$$\varepsilon_{\delta} = 100 (\cos \delta - 1) \% \quad (4)$$

The error in the single beam is:

$$\begin{aligned} \varepsilon'_{\delta} &= 100 (\cos \delta + \tan \theta \sin \delta - 1) \% \text{ or} \\ \varepsilon'_{\delta} &= 100 (\cos \delta - \tan \theta \sin \delta - 1) \% \quad (5) \end{aligned}$$

This shows that the error in dual beams is always a negative value regardless of the beam irradiation angle.

When a slope of 5° occurs, the error can be calculated as follows:

$$\varepsilon_{\delta} = -0.38 \%$$

$$\varepsilon'_{\delta} = -32.1 \text{ or } -32.9 \%$$

As shown above, the error of the dual beam system is smaller than that of the single beam system, so that the dual beam system is more favorable.

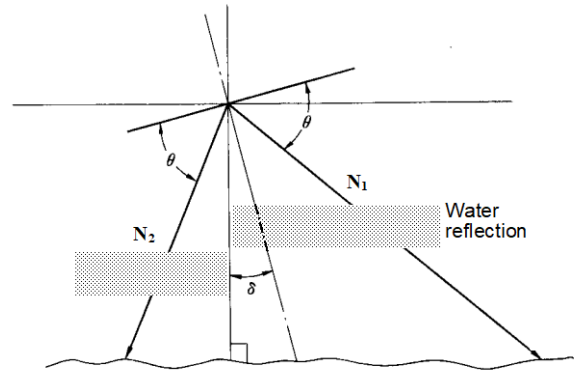

Figure 3 Error by leaning

3 Error by pitching and rolling

When pitching and rolling occur, the results are equal to the case where δ in expression in (4) and expression (5) is replaced with the following:

$$\delta \rightarrow \delta(t) = \delta_m \sin \omega t$$

δ_m : Maximum deflection angle

ω : Angle frequency of motion

The average Doppler shift frequency in dual beams is as follows:

$$\begin{aligned} \overline{f_d} &= \overline{f_{d1} - f_{d2}} = \frac{1}{T} \int_{-\frac{T}{2}}^{\frac{T}{2}} \cos \theta \cos \delta(t) dt \\ &= \frac{4Vf_0}{C} \cos \theta \cdot \frac{\omega}{2\pi} \int_{-\frac{\pi}{\omega}}^{\frac{\pi}{\omega}} \cos(\delta_m \sin \omega t) dt \\ &= \frac{4Vf_0}{C} J_0(\delta_m) \end{aligned} \quad (6)$$

The average error is calculated as follows.

$$\overline{\varepsilon} \delta_m = 100 \{J_0(\delta_m) - 1\} \quad (7)$$

Figure 4 shows the errors attributed to angles based on the results indicated above.

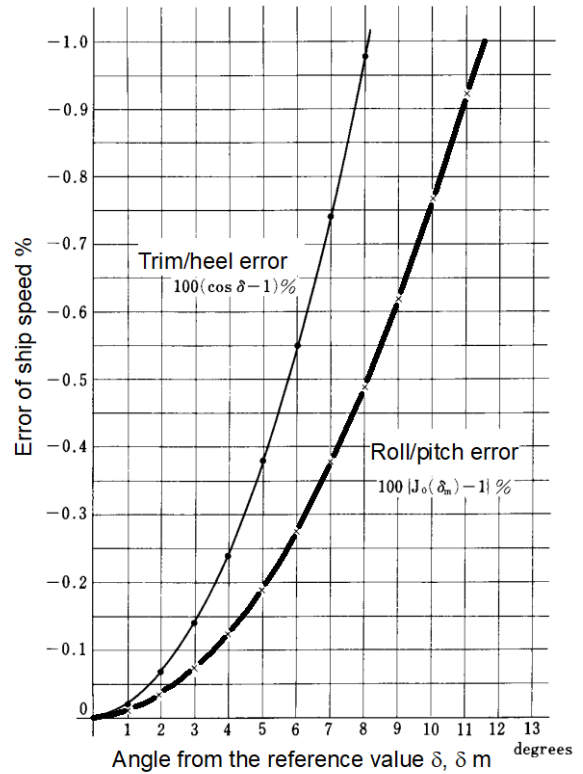
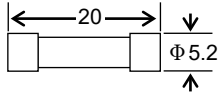
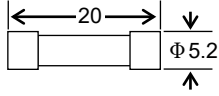
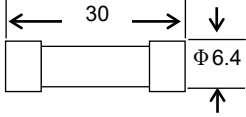
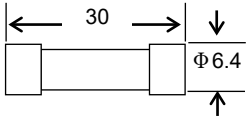
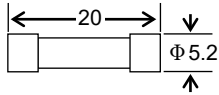
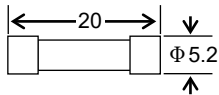

Figure 4 Errors by vertical slopes in dual beams

(This page intentionally left blank)

Appendix D Spare Parts List

SHIP No.	SPARE PARTS LIST FOR	USE	SETS PER VESSEL			
	JLN-740A/740N/741A/741N Doppler Log		1			
ITEM No.	NAME OF PART	OUTLINE (Dimension in mm)	QUANTITY		REMARKS	
			WORKING	SPARE	DESCRIPTION	SUB MARK OF BOX No.
			PER SET	PER VESS	JRC CODE No.	
1	Fuse		2		MF51NR 250V 2 5ZFGD00200	
2	Fuse		2		MF51NR 250V 5 5ZFGD00183	
3	Fuse		1		MF60NR 250V 2 5ZFGD00010	
4	Fuse		1		MF60NR 250V 1 5ZFGD00205	
5	Fuse		2		MF51NR 250V 4 5ZFGD00117	
6	Fuse		2		MF51NR 250V 0.5 5ZFGD00019	
MFR'S NAME		JAPAN RADIO CO.,LTD.	DRW. No.		7ZXNA3007	

APP D

(This page intentionally left blank)

アスベストは使用していません
Not use the asbestos

For further information, contact:

JRC *Japan Radio Co., Ltd.*

Since 1915

URL Head office : <http://www.jrc.co.jp/eng/>

Marine Service Department

1-7-32 Tatsumi, Koto-ku, Tokyo 135-0053, Japan

e-mail : tmsc@jrc.co.jp

One-call : +81-50-3786-9201

ISO 9001, ISO 14001 Certified

CODE No.7ZPNA3208

APR. 2022 Edition 5