

JAN-7201/9201

ECDIS

Instruction Manual

<Basic Operation>

Overview	1
Name and Function of Each Unit	2
Common Basic Operations	3
Range and Bearing Measurement Methods	4
Target Tracking and AIS	5
Functions of the ECDIS	6
Route Planning	7
Route Monitoring	8
Monitoring a Dragging Anchor	9
Automatic Sailing (Option)	10
Operating a Chart	11
Creating a User Chart/ Updating a Chart Manually	12
Logbook	13
Setting Up Screen View	14
Setting Up Alerts	15
Setting Up the Operation Mode	16
Adjusting and Setting Up Equipment (for Services)	17
Playing Back Data Recorded During Navigation [Playback]	18
Maintenance & Inspection	19
Failures and After-Sale Services	20
About Disposal	21
Specifications	22
Alert List	APP A
Menu List and Materials	APP B



Japan Radio Co., Ltd.

PREFACE

Thank you for purchasing JAN-7201/9201.

This equipment meets the performance standards of the IMO (International Maritime Organization) and the IHO (International Hydrographic Organization), and serves to improve safety, reduce fuel combustion, concentrate voyage information as the main device of the INS (Integrated Navigation System).

- For the best operation, read this manual thoroughly before use.
- Keep this manual in a convenient place for future reference.
Make use of this manual when experiencing operation difficulties.
- The LCD of this equipment uses thin film transistors (TFT). If some pixels on the screen are not clear, the color is different, or the screen is brighter than usual, it is not because of defect, instead it is because of inherent characteristic of the TFT display technology.
- The information in this manual is subject to change without notice at any time.

● Safety Cautions ●

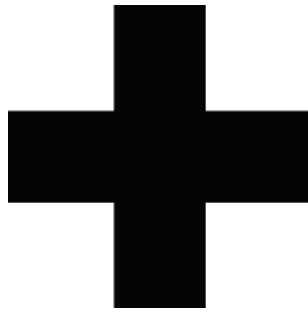

Cautions for High Voltage

High voltages, ranging from several hundreds to tens of thousands of volts, are used in electronic apparatus, such as radio and radar instruments. These voltages are totally harmless in most operations. However, touching a component inside the unit is very dangerous. (Any person other than authorized service engineers should not maintain, inspect, or adjust the unit.) High voltages on the order of tens of thousand volts are most likely to cause instant deaths from electrical shocks. At times, even voltages on the order of several hundred volts could lead to electrocution. To defend against electrical shock hazards, don't put your hand into the inside of apparatus. When you put in a hand unavoidably in case of urgent, it is strongly suggested to turn off the power switch and allow the capacitors, etc. to discharge with a wire having its one end positively grounded to remove residual charges. Before you put your hand into the inside of apparatus, make sure that internal parts are no longer charged. Extra protection is ensured by wearing dry cotton gloves at this time. Another important precaution to observe is to keep one hand in your pocket at a time, instead of using both hands at the same time.

It is also important to select a secure footing to work on, as the secondary effects of electrical shock hazards can be more serious. In the event of electrical shocks, disinfect the burnt site completely and obtain medical care immediately.

Precautions for Rescue of Victim of Electric Shock

When a victim of electric shock is found, turn off the power source and ground the circuit immediately. If this is impossible, move the victim away from the unit as quick as possible without touching him or her with bare hands. He or she can safely be moved if an insulating material such as dry wood plate or cloth is used.

Breathing may stop if current flows through the respiration center of brain due to electric shock. If the electric shock is not large, breathing can be restored by artificial respiration. A victim of electric shock looks pale and his or her pulse may become very weak or stop, resulting in unconsciousness and rigidity at worst. It is necessary to perform first aid immediately.

● Emergency Measures ●

Method of First-Aid Treatment

☆ Precautions for First-Aid Treatments

Apply artificial respiration to the person who collapsed, minimizing moving as much as possible avoiding risks. Once started, artificial respiration should be continued rhythmically.

- (1) Refrain from touching the patient carelessly as a result of the accident; the first-aider could suffer from electrical shocks by himself or herself.
- (2) Turn off the power calmly and certainly, and move the patient apart from the cable gently.
- (3) Call or send for a physician or ambulance immediately, or ask someone to call doctor.
- (4) Lay the patient on the back, loosening the necktie, clothes, belts and so on.
- (5)
 - (a) Feel the patient's pulse.
 - (b) Check the heartbeat by bringing your ear close to the patient's heart.
 - (c) Check for respiration by bringing your face or the back of your hand to the patient's face.
 - (d) Check the size of patient's pupils.
- (6) Opening the patient's mouth, remove artificial teeth, cigarettes, chewing gum, etc. if any. With the patient's mouth open, stretch the tongue and insert a towel or the like into the mouth to prevent the tongue from being withdrawn into the throat. (If the patient clenches the teeth so tight that the mouth won't open, use a screwdriver or the like to force the mouth open and then insert a towel or the like into the mouth.)
- (7) Wipe off the mouth to prevent foaming mucus and saliva from accumulating.

★ Treatment to Give When the Patient Has a Pulse Beating but Has Ceased to Breathe

* Performing mouth-to-mouth artificial respiration

- (1) Bend the patient's face backward until it is directed to look back. (A pillow may be placed under the neck.)
- (2) Pull up the lower jaw to open up the airway. (To spread the airway)
- (3) Pinching the patient's nose, breathe deeply and blow your breath into the patient's mouth strongly, with care to close it completely. Then, move your mouth away and take a deep breath, and blow into his or her mouth. Repeat blowing at 10 to 15 times a minute (always with the patient's nostrils closed).
- (4) Continue artificial respiration until natural respiration is restored.
- (5) If the patient's mouth won't open easily, insert a pipe, such as one made of rubber or vinyl, into either nostril. Then, take a deep breath and blow into the nostril through the pipe, with the other nostril and the mouth completely closed.
- (6) The patient may stand up abruptly upon recovering consciousness. Keep the patient lying calmly, giving him or her coffee, tea or any other hot drink (but not alcoholic drink) to keep him or her warm.

Mouth-to-mouth artificial respiration with the patient's head lifted



- [1] 
- (1) Lift the back part of the patient's head. Support the forehead with one of your hand and the neck with the other hand. → [1].
Many patients will have their airways opened by lifting their head in this way to ease mouth-to-mouth artificial respiration.
- [2] 
- (2) Closing the patient's mouth with your mouth, press your cheek against the patient's nose → [2].
Alternatively, hold the patient's nose with your finger to prevent air leak → [3].
- [3] 
- (3) Blowing air into the patient's lungs. Blow air into the patient's lungs until chest is seen to rise. The first 10 breaths must be blown as fast as possible.

Fig. 1 Mouth-to-mouth artificial respiration

First Aid Method

Flow of Cardiopulmonary Resuscitation (CPR)

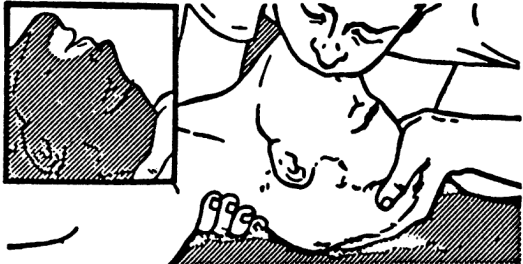

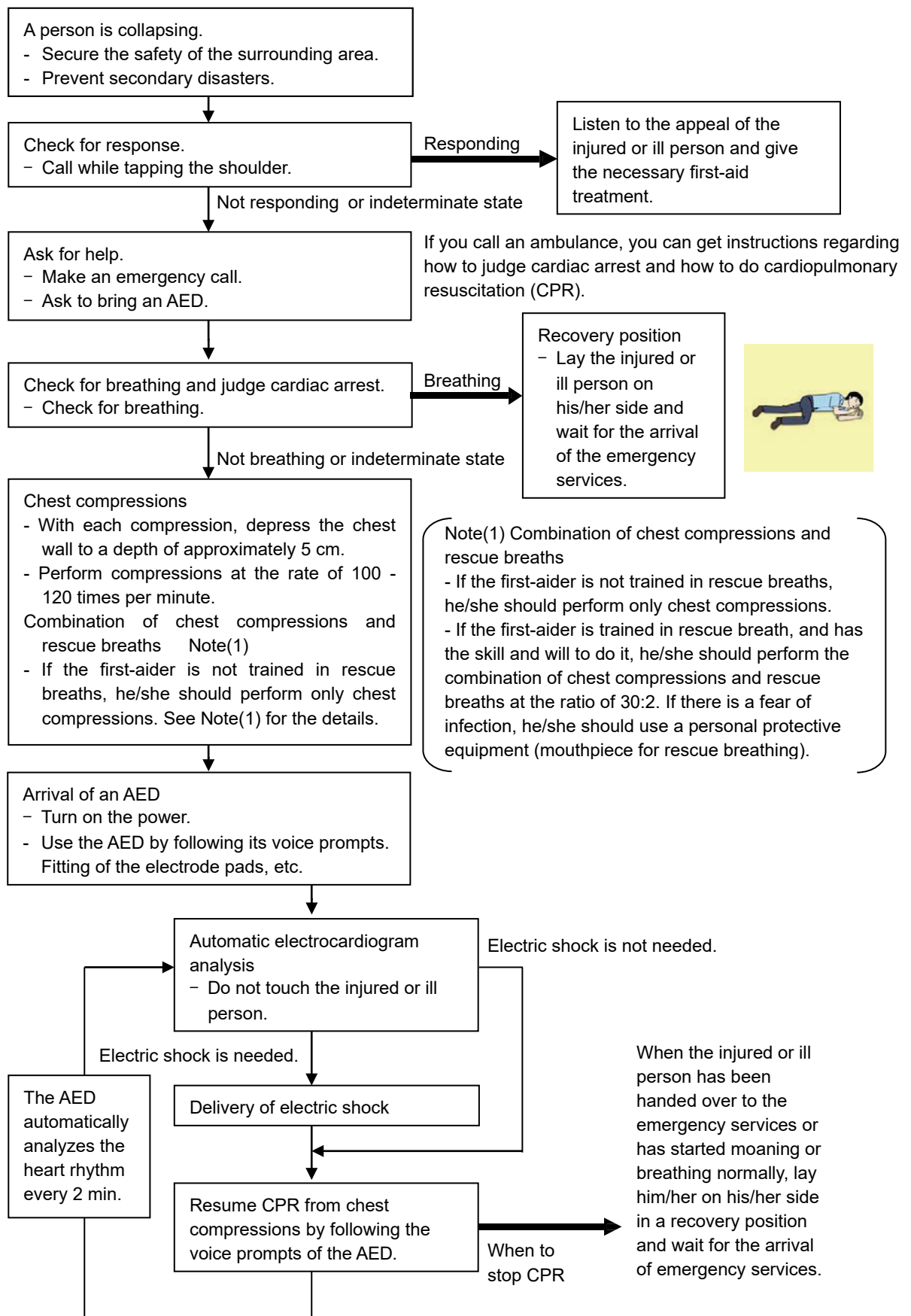
Specific Procedures for Cardiopulmonary Resuscitation (CPR)

1. Check the scene for safety to prevent secondary disasters

- a) Do not touch the injured or ill person in panic when an accident has occurred. (Doing so may cause electric shock to the first-aiders.)
- b) Do not panic and be sure to turn off the power. Then, gently move the injured or ill person to a safe place away from the electrical circuit.

2. Check for responsiveness

- a) Tap the shoulder of the injured or ill and shout in the ear saying, "Are you OK?"
- b) If the person opens his/her eyes or there is some response or gesture, determine it as "responding." But, if there is no response or gesture, determine it as "not responding."



3. If responding

- a) Give first-aid treatment.

4. If not responding

- a) Ask for help loudly. Ask somebody to make an emergency call and bring an AED.
 - Somebody has collapsed. Please help.
 - Please call an ambulance.
 - Please bring an **AED**.
 - If there is nobody to help, call an ambulance yourself.

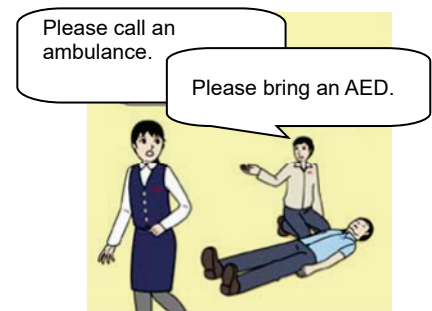

5. Check for breathing

- a) Look to see if the chest and abdomen of the injured or ill person are rising and falling.

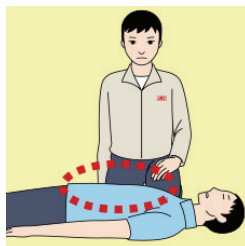

- b) If the injured or ill person is breathing, place him/her in the recovery position and wait for the arrival of the emergency services.
 - Position the injured or ill person on his/her side.

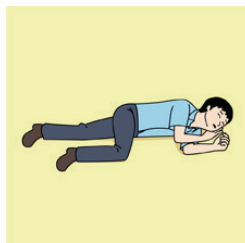

6. Cardiopulmonary resuscitation (CPR) (combination of chest compressions and rescue breaths)

a) Chest compressions

1) Position of chest compressions

- Position the heel of one hand in the center of the chest, approximately between the nipples, and place your other hand on top of the one that is in position.

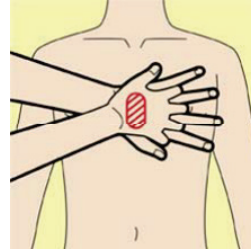
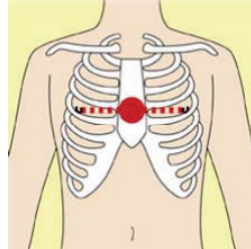

2) Perform chest compressions

Perform uninterrupted chest compressions of 30 at the rate of about 100 - 120 times per minute, while locking your elbows positioning yourself vertically above your hands.

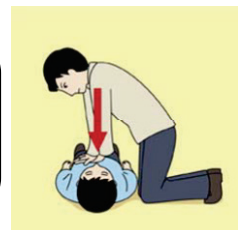
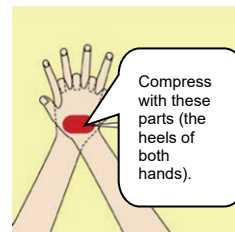

- With each compression, depress the chest wall to a depth of approximately 5 cm.

b) Combination of 30 chest compressions and 2 rescue breaths

- 1) If the first-aider is not trained in rescue breaths, he/she should perform only chest compressions.
- 2) If the first-aider is trained in rescue breath, and has the skill and will to do it, he/she should perform 30 chest compressions, then give 2 rescue breaths.
- 3) If there is a fear of infection, he/she should use a personal protective equipment (mouthpiece for rescue breathing).
- 4) Continuously perform the combination of 30 chest compressions and 2 rescue breaths without interruption.
- 5) If there are two or more first-aiders, alternate with each other approximately every two minutes (five cycles) without interruption.

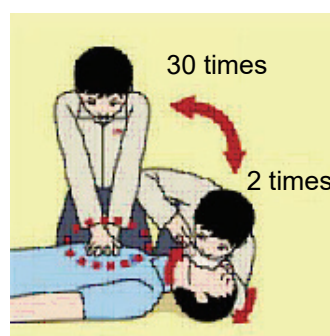
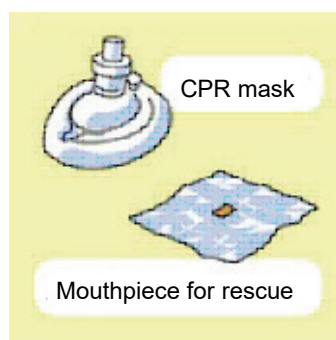

7. When to stop cardiopulmonary resuscitation (CPR)

- When the injured or ill person has been handed over to the emergency services
- When the injured or ill person has started moaning or breathing normally, lay him/her on his/her side in a recovery position and wait for the arrival of emergency services.

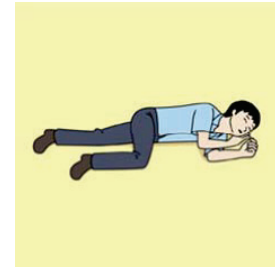

8. Arrival and preparation of an AED

- Place the AED at an easy-to-use position.
If there are multiple first-aiders, continue CPR until the AED becomes ready.
- Turn on the power to the AED unit.
Depending on the model of the AED, you may have to push the power on button, or the AED automatically turns on when you open the cover.
- Follow the voice prompts of the AED.

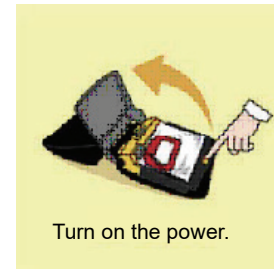

9. Attach the electrode pads to the injured or ill person's bare chest

- Remove all clothing from the chest, abdomen, and arms.
- Open the package of electrode pads, peel the pads off and securely place them on the chest of the injured or ill person, with the adhesive side facing the chest. If the pads are not securely attached to the chest, the AED may not function. Paste the pads exactly at the positions indicated on the pads. If the chest is wet with water, wipe dry with a dry towel and the like, and then paste the pads. If there is a pacemaker or implantable cardioverter defibrillator (ICD), paste the pads at least 3 cm away from them. If a medical patch or plaster is present, peel it off and then paste the pads. If the injured or ill person's chest hair is thick, paste the pads on the chest hair once, peel them off to remove the chest hair, and then paste new pads.
- Some AED models require to connect a connector by following voice prompts.
- The electrode pads for small children should not be used for children over the age of 8 and for adults.

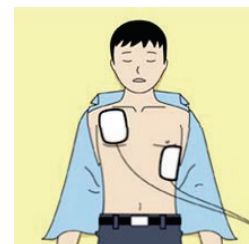
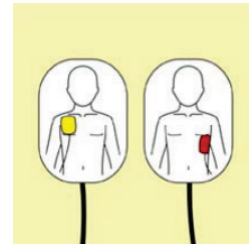

10. Electrocardiogram analysis

- The AED automatically analyzes electrocardiograms. Follow the voice prompts of the AED and ensure that nobody is touching the injured or ill person while you are operating the AED.
- On some AED models, you may need to push a button to analyze the heart rhythm.



11. Electric shock (defibrillation)

- a) If the AED determines that electric shock is needed, the voice prompt saying, "Shock is needed" is issued and charging starts automatically.
- b) When charging is completed, the voice prompt saying, "Press the shock button" is issued and the shock button flashes.
- c) The first-aider must get away from the injured or ill person, make sure that no one is touching him/her, and then press the shock button.
- d) When electric shock is delivered, the body of the injured or ill person may jerk.



12. Resurgence of cardiopulmonary resuscitation (CPR)

- a) Resume chest compressions by following the voice prompts of the AED.
 - With each compression, depress the chest wall to a depth of approximately 5 cm.
 - Perform compressions at the rate of 100 - 120 times per minute.

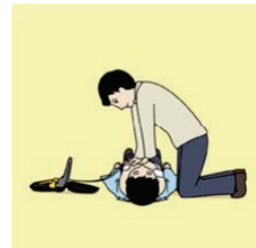

13. Automatic electrocardiogram analysis

- a) When 2 minutes have elapsed since you resumed cardiopulmonary resuscitation (CPR), the AED automatically analyzes the electrocardiogram.
- b) If you suspended CPR by following voice prompts and AED voice prompt informs you that shock is needed, give electric shock again by following the voice prompts.
If AED voice prompt informs you that no shock is needed, immediately resume CPR.

14. When to stop CPR (Keep the electrode pads on.)

- a) When the injured or ill person has been handed over to the emergency services
- b) When the injured or ill person has started moaning or breathing normally, lay him/her on his/her side in a recovery position and wait for the arrival of emergency services.

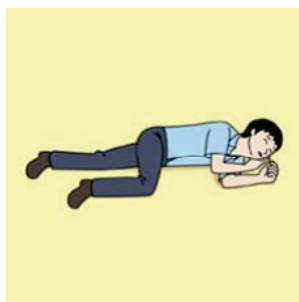



● Pictorial Indication ●

Meanings of Pictorial Indication

Various pictorial indications are included in this manual and are shown on this equipment so that you can operate them safely and correctly and prevent any danger to you and / or to other persons and any damage to your property during operation. Such indications and their meanings are as follows.

Please understand them before you read this manual:

 DANGER	This indication is shown where incorrect equipment operation due to negligence may cause death or serious injuries.
 WARNING	This indication is shown where any person is supposed to be in danger of being killed or seriously injured if this indication is neglected and these equipment are not operated correctly.
 CAUTION	This indication is shown where any person is supposed to be injured or any property damage is supposed to occur if this indication is neglected and these equipment are not operated correctly.

Examples of Pictorial Indication



Electric Shock

The \triangle mark represents CAUTION (including DANGER and WARNING).

Detailed contents of CAUTION ("Electric Shock" in the example on the left) is shown in the mark.



Disassembling
Prohibited



The \otimes mark represents prohibition.

Detailed contents of the prohibited action ("Disassembling Prohibited" in the example on the left) is shown in the mark.



Disconnect
the power plug



The \bullet mark represents instruction.

Detailed contents of the instruction ("Disconnect the power plug" in the example on the left) is shown in the mark.

Warning Label

There is a warning label on the top cover of the equipment. Do not try to remove, break or modify the label.

● Precautions upon Equipment Operation ●

DANGER



Never attempt to check or repair the inside of the equipment.
Checking or repair by an unqualified person may cause a fire or an electric shock.
Contact our head office, or a nearby branch or local office to request servicing.



Never remove the cover of this equipment.
Touching the high-voltage section inside will cause an electric shock.



Do not attempt to disassemble or tamper with this equipment.
Otherwise, a fire, an electric shock, or a malfunction may occur.



When conducting maintenance, make sure to turn the main power off.
Failure may result in electric shock.



Turn off all the main powers before cleaning the equipment. Especially when an UPS is used, make sure to turn it off since voltage is still outputted from the UPS even after the indicator and the ECDIS are turned off. Failure may result in equipment failure, or death or serious injury due to electric shock.

WARNING



When turning off the power supply, do not hold down the power button of the operation unit.
Otherwise, a trouble may occur due to termination failure.



When conducting maintenance work, make sure to turn off the power so that the power supply to the equipment is completely cut off.
Some equipment components can carry electrical current even after the power switch is turned off, and conducting maintenance work may result in electric shock, equipment failure, or accidents.



When cleaning the screen and Trackball of Operation Unit, do not wipe hard with a dry cloth. Also, do not use glass cleaner, alcohol, gasoline, or thinner to clean the screen. Also avoid wiping with water. It may cause surface damage or equipment failure.



Do not change Initial Level/Area Offset unless absolutely necessary.
Incorrect adjustment will result in deletion of nearby target images and thus collisions may occur resulting in death or serious injuries.



Confirm computer virus does not exist in USB flash memory beforehand when reading and writing of the file by using USB flash memory.
Influences other equipment when the display unit is infected with the virus, and it may cause a breakdown.



Do not remove USB flash memory while the access lamp (in USB flash drive) is flashing.
Data may be damaged when the USB flash memory is inserted or removed while accessing it, and it may cause a breakdown.



Do not place a glass or cup containing water, etc., or a small metal object on this equipment.
If water or such object gets inside, a fire, an electric shock, or a malfunction may occur.



In case water or a metal object gets inside the equipment, turn off the power immediately, unplug the power supply cable from an electric outlet, and contact our head office, or a nearby branch or local office to request servicing.
Keeping the equipment in operation under such condition may cause a fire, an electric shock or a malfunction.



In case you find smoke, unusual odor or extreme high heat coming from the equipment, turn off the power immediately, unplug the power supply cable from an electric outlet, and contact our head office, or a nearby branch or local office to request servicing.
Keeping the equipment in operation under such condition may cause a fire or an electric shock.

WARNING



Do not use the offset function during navigation.
If the equipment is used with the offset value entered as the own ship position (deviated from the actual position), accidents may result.
When the offset values are entered, the [Offset] badge is displayed at the position display on the Own Ship Information. Check the indication, and cancel the offset function if necessary. Also, the message "Position Shift" is displayed in the message display area.

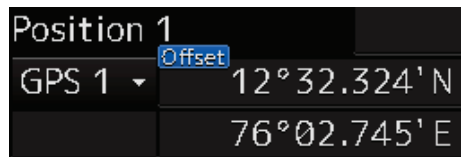

Before starting automatic sailing, be sure to check the safety of the route and the safety when crossing safety contour.
Otherwise, accidents may result.



If the own ship has arrived at the boundary of a WPT during automatic sailing, be sure to check the safety and perform turning manually by the operator him/herself.
Otherwise, the ship keeps the course with the leg bearing, and accidents may result.



Input the ship's parameter accurately according to the specification of the ship.
Otherwise, accidents may result.



Change of the color of the Day/Night button, particularly the use of the [Night] color, may interfere with the recognition of display information.



When moving the dialog box, move to the position that does not cover the operation area. If the dialog box covers the operation area, it may interfere the recognition of the display information.

CAUTION



Use Target Tracking (TT) function only as a navigation aid. The final navigation decision must always be made by the operator him/herself. Making the final navigation decision based only on tracking target information may cause accidents.

Tracking target information such as vector, target numerical data, and alarms may contain some errors. Also, targets that are not detected by the radar cannot be acquired or tracked.

Making the final navigation decision based only on the radar display may cause accidents such as collisions or running aground.



Since these alarms may include some errors depending on the target tracking conditions, the navigation officer himself should make the final decision for ship operations such as collision avoidance.

Making the final navigation decision based only on the alarm may cause accidents such as collisions.



Make sure that two or more staff member work together when replacing the LCD. If only one person attempts to replace the LCD, he/she may drop it and become injured.



Any adjustments must be made by specialized service personnel.

Incorrect settings may result in unstable operation, and this may lead to accidents or equipment failure.



Do not make any adjustments during navigation.

Failure may result in adverse effects on the radar function which may lead to accidents or equipment failure.



Do not change the quantization level settings unless absolutely necessary.

If set at an inappropriate value, the acquisition of target tracking function and the tracking function deteriorate, and this may lead to accidents.



Do not use or leave the equipment under direct sunlight for a long time or in the temperatures above 55°C.

Otherwise, a fire or a malfunction may occur.



Do not block the ventilation opening of the equipment.

Otherwise, heat may accumulate inside to cause a fire or a malfunction.

CAUTION



This equipment is intended for use as an aid to navigation only.

- If no backup measures, such as using another ECDIS unit for confirmation, are taken, be sure to use official marine charts together with this equipment to make any navigational decision.
- This equipment is not designed to assess the positional information automatically.
The positional information should always be checked by the operator.
Otherwise, accidents may result.



Do not touch the equipment with hands or gloves wet with water.
Otherwise, an electric shock or a malfunction may occur.



Do not leave the disc in the DVD drive.
Malfunctions of the drives may result.



- Do not place any object on the operation panel.
In particular, if a hot object is placed on the operation panel, it can cause deformation of the surface of the operation panel.
- Do not apply any undue shock on the operation panel, trackball and dials.
Otherwise, a malfunction may result.



Make sure that the main power is turned off before inspection or replacement of parts.
Otherwise, an electric shock, a fire, or a malfunction may occur.



- If a fan alarm or CPU temperature rise alarm has occurred, immediately turn off the power.
Keeping the equipment in operation under such condition may cause a fire or a malfunction.
After turning off the power, contact our head office, or a nearby branch or local office to request servicing.



Edit routes in accordance with the world geodetic system (WGS-84).
Use of routes edited with any other geodetic systems may cause accidents.



During sailing, be sure to check the own ship's position and bearing as often as necessary, regardless of whether the automatic sailing is in operation or not.
Otherwise, accidents may result.

CAUTION



Do not turn off the power during Backup/Restore.
Otherwise, a function may fail, and an accident may occur.



Do not do the backup operation of data while sailing.
The ECDIS application should be ended to begin the data backup. It becomes impossible to observe using the ECDIS and this may lead to accidents.



Before performing recovery of images in C drive, make sure that the backup power supply (such as DC power supply) of the equipment is connected. If the power supply is disconnected during recovery operation, equipment activation failure may occur, causing an accident.



Do not turn off the power supply during recovery operation of the images in C drive.
Otherwise, a function fault may occur, causing an accident.



In the case of turning on the power under the condition of low temperature, do pre-heat more than 30 minutes.
Otherwise, an operation failure may occur and an accident may occur.

The Mounting Point of the Warning Label

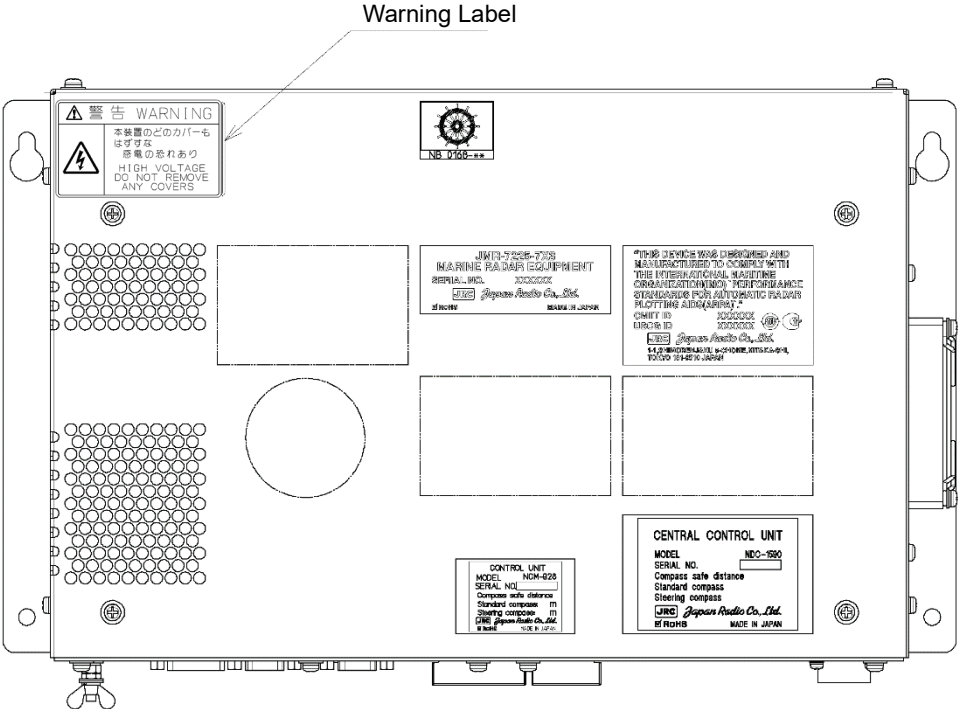

NDC-1590/A Central Control Unit

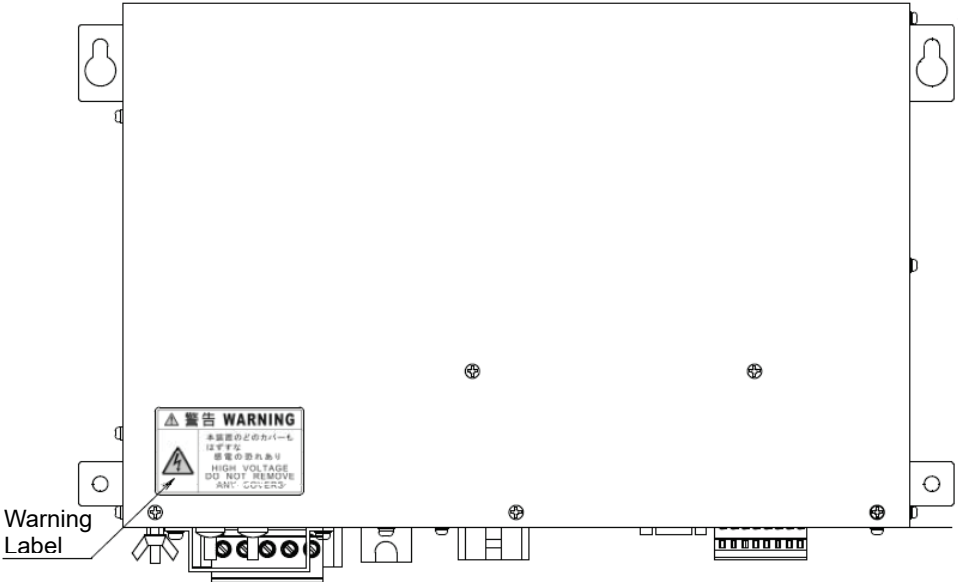

NBD-913 Power Supply Unit

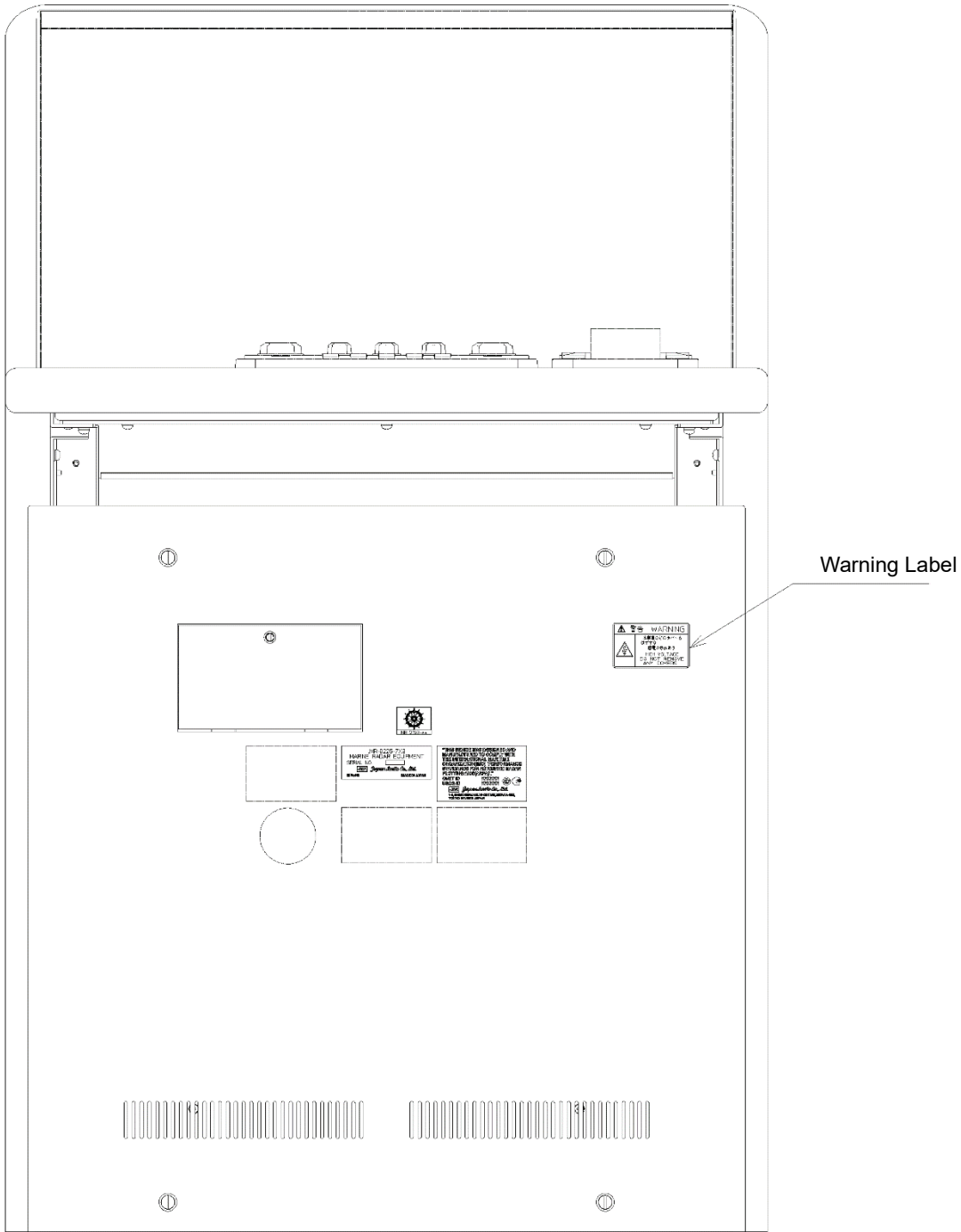

CWA-246 26inch Display Unit Mount Kit

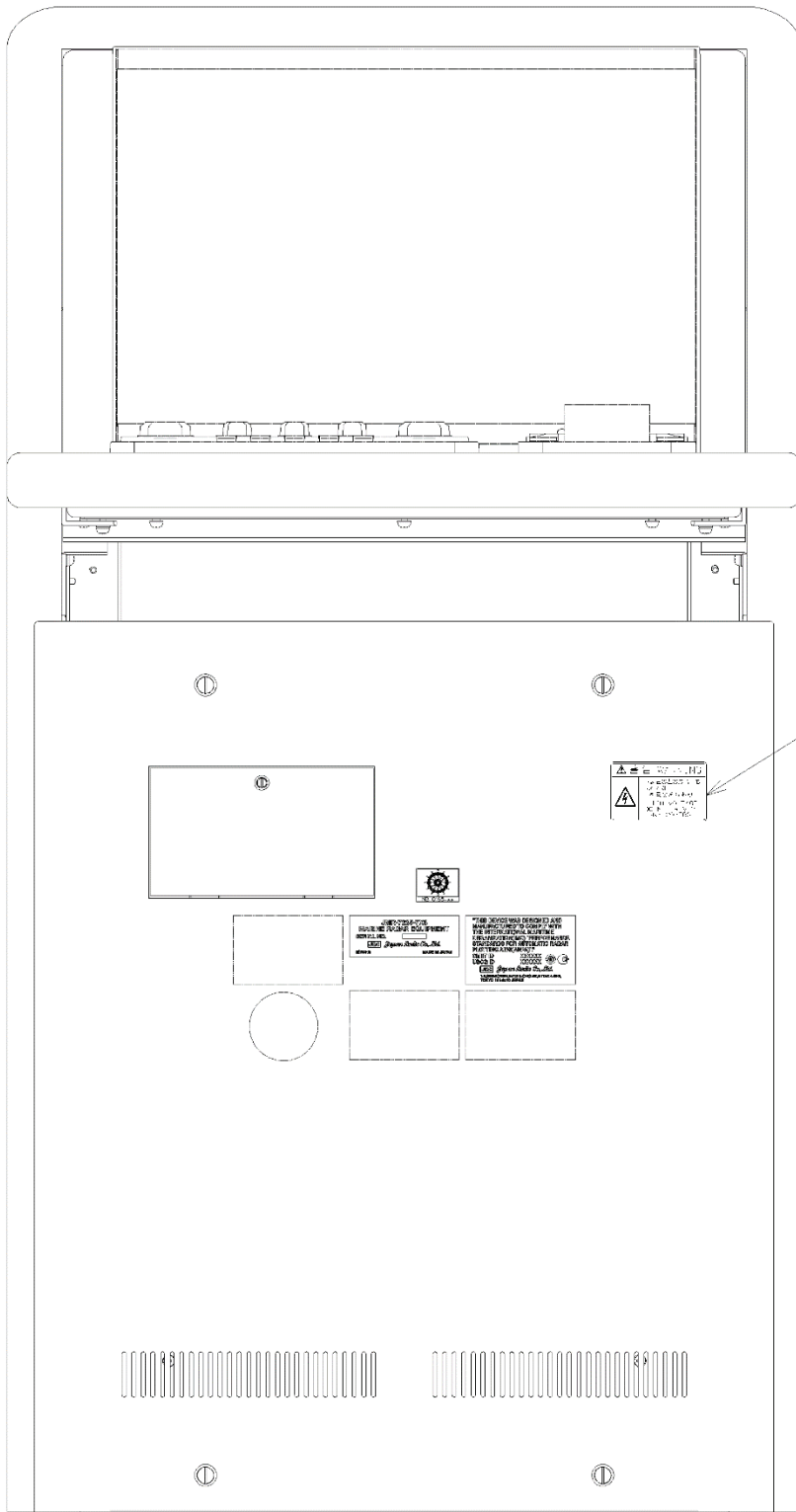

Warning label

CWA-245 19inch Display Unit Mount Kit

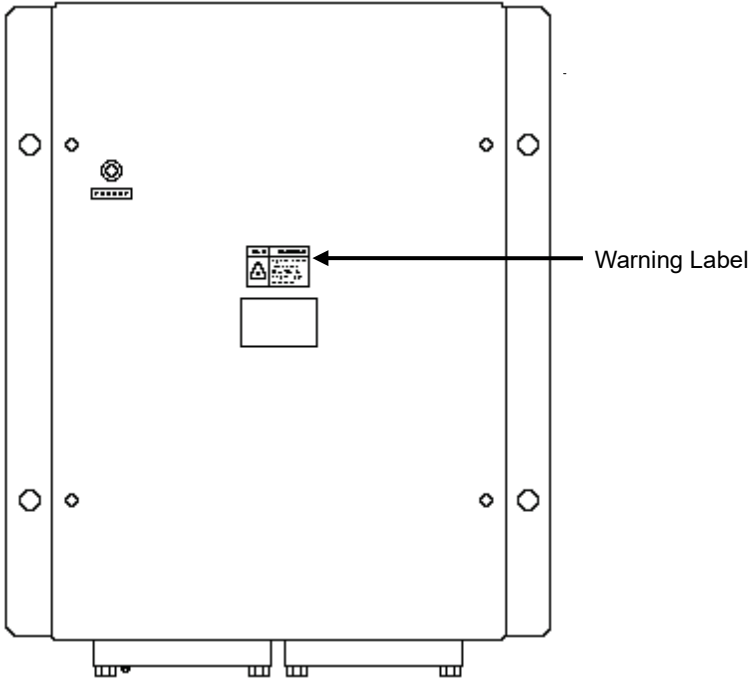

NQE-3141-4A/8A Interswitch Unit

EQUIPMENT APPEARANCE



CWA-245 Display Unit



CWA-246 Display Unit with tray



CWA-246 Display Unit without tray



NCE-5605 Trackball Operation Unit



NCE-5625 Keyboard Operation Unit (Option)



NDC-1590/A Central Control Unit



NBD-913 Power Supply Unit



NWZ-207/214 19inch Display



NWZ-208 26inch Display

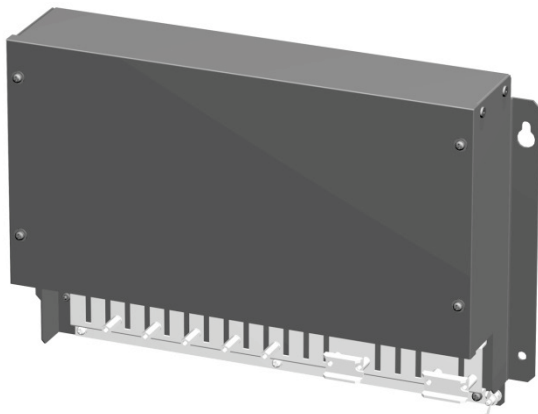

NQE-1143 Junction box (Option)

Glossary

Activated target	: A target representing the automatic or manual activation of a sleeping AIS target for the display of additional information
AIO	: Admiralty Information Overlay published by United Kingdom Hydrographic Office (UKHO).
AIS	: Automatic Identification System
Anti-clutter rain	: Rain/snow clutter suppression
Anti-clutter sea	: Sea clutter suppression
ARCS	: Admiralty Raster Chart Service. A raster chart published by UKHO
Associated target	: A target simultaneously representing a tracked target and a AIS target which are decided as the same
AUTO SAIL	: The system automatically navigates to keep the scheduled route. Same as automatic sailing.
AZ	: Acquisition/Activation zone
AZI	: AZimuth stabilization mode
Base CD	: Chart CD containing a complete chart data
BCR/BCT	: Bow Crossing Range/Bow Crossing Time
CCRP	: Consistent Common Reference Point. The own ship position, to which all horizontal measurements such as target range, bearing, relative course, relative speed, CPA or TCPA are referenced, typically the conning position of the bridge.
Cell Permit	: A file containing an encryption key for S-63 chart. Supplied by UKHO, PRIMAR STAVANGER, and Hydrographic and Oceanographic Department of Japan Coast Guard.
Chart Maintenance	: Software to manage the charts. Imports and updates the charts.
Chirp	: A type of transmission waveform with intra-pulse frequency modulation used by solid-state radars. Its radio wave type is classified as Q0N.
Clutter	: Unwanted reflections on a radar screen, from sea surface, rain or snow.
C-MAP	: Digital chart data by Jeppesen (formerly, C-MAP, Norway)

C-MAP Ed.3	: C-MAP Edition 3. A digital chart format by Jeppesen (formerly, C-MAP, Norway) CTS : Course To Steer. Heading command.
COG	: Course Over the Ground
CORREL	: CORRELation
CPA/TCPA	: Distance to the Closest Point of Approach/Time to the Closest Point of Approach.
CTS	: Course To Steer. Heading command.
CTW	: Course Through Water. The direction of the ship's movement through the water
C UP	: Course up. Own ship's course is pointed to the top center of the radar display.
Data Server	: Organization providing S-63 chart
Display	: Screen displayed on the LCD
DIST	: Distance
DNV	: Det Norske Veritas
DR	: Dead Reckoning
DRIFT	: The current velocity for manual correction or the current speed on the horizontal axis of the 2-axis log is displayed.
Dynamic License	: Dynamic licensing of C-Map chart license by Jeppesen
EBL	: Electronic Bearing Line
ECDIS	: Electronic Chart Display and Information System
ENC	: Electronic Navigation Chart. Meaning S-57 and S-63.
ENH	: Enhance
ETA	: Estimated Time of Arrival
ETD	: Estimated Time of Departure
F.ETA	: Final Estimated Time of Arrival. Estimated time of arrival to the last WPT
Frequency deviation range	: The range of variation of the Q0N frequency used for transmission waves of a solid-state radar. Generally, the greater the frequency deviation range, the higher the resolution in the range direction.
GC	: Great Circle

GPS	:	Global Positioning System
HDG	:	Heading. Ship's heading
HL	:	Heading Line
HSC	:	High Speed Craft. Vessels which comply with the definition in SOLAS for high speed craft
H UP	:	Head up. Own ship's heading line is always pointed to the top center of the radar display.

Hydrographic and Oceanographic Department :

Hydrographic and Oceanographic Department of Japan Coast Guard.
 Publisher of ENC

IHO	:	International Hydrographic Office
IMO	:	International Maritime Organization
Import (Chart Maintenance)	:	A procedure of enabling the chart supplied by Base CD to be displayed on ECDIS
Interswitch Unit	:	A device to switch over two or more radar display units and two or more radar antennas
IR	:	Radar Interference Rejecter
ISW	:	InterSWitch unit
LAT	:	Latitude
Leg	:	Line between two consecutive waypoints
LMT	:	Local Mean Time
LON	:	Longitude
Lost tracked target	:	One for which target information is no longer available due to poor, lost or obscured signals.
LP	:	Long Pulse
MED	:	Marine Equipment Directive. Request standard for standardization of marine equipment within the EU region
MFD	:	Abbreviation of this equipment name. The formal name is Multi Function Display. The navigation support functions such as radar, ECDIS, CONNING, and CAM with this equipment can be executed by switching.
MMSI	:	Maritime Mobile Service Identity

MOB	:	Man Over Board
MON	:	Performance Monitor
MP	:	Medium Pulse
NM	:	Nautical Mile 1 nm=1852 m
N UP	:	The north is always pointed to the top center of the radar display. (North up)
P0N	:	Unmodulated pulse, which is a type of transmission radio wave. While it is a type of radio wave usually used by radars equipped with magnetrons, radio waves with a short pulse length are used also by solid-state radars for short-range detection.
Past positions	:	Equally time-spaced past position marks of a tracked or AIS target and the own ship.
PI	:	Parallel Index line
POSN	:	POSitioN
Power amplifier	:	A radio frequency amplifier circuit consisting of semiconductor elements used for solid-state radars. It employs a high frequency, high power FET.
PRF	:	Pulse Repetition Frequency. The number of radar pulses transmitted each second.
PRIMAR STAVENGER	:	A Norwegian company supplying charts. Publisher of encrypted charts, S-63
Primary	:	Main positioning sensor
PROC	:	PROcess. Radar signal processing function
Pulse compression	:	Correlation processing performed when a transmitted chirp signal is received by a solid-state radar after reflecting off the target. This processing gain enables the radar to have necessary detection capability even when a transmission power is low.
Q0N	:	A type of radio wave with intra-pulse frequency modulation. It is used for solid-state pulse compression radars.
Radar beacon	:	A navigation aid which responds to the radar transmission and generates radio wave
Range	:	An area of the chart displayed on the screen. Represented by one half of the length of the chart display screen.
Reference target	:	A fixed target specified to calculate the speed over the ground
Relative vector	:	A predicted movement of a target relative to own ship's motion

Report	:	User report to be issued periodically for using the Dynamic License method of Jeppesen continuously
RL	:	Rhumb Line
RM	:	Relative Motion. A display on which the position of own ship remains fixed, and all targets move relative to own ship.
RM(R)	:	Relative Motion. Relative Trails
RM(T)	:	Relative Motion. True Trails
ROT	:	Rate Of Turn. Change of heading per time unit
Route	:	A set of waypoints
RR	:	Range Rings
Rubber band	:	Border that indicates the selected range.
S-57	:	IHO Transfer Standard for Digital Hydrographic Data
S-63	:	IHO Data Protection Scheme
SA Certificate file	:	An electronic file certifying the supplier of S-63 chart. Required for import/ update of S-63 chart.
SART	:	Search And Rescue Transponder
Scale	:	The display scale
Sea state	:	The average height of the wave expressed by dividing into several classes.
SENC	:	System Electronic Navigational Chart
SET	:	The current direction for manual correction or the current speed on the horizontal axis of the 2-axis log is displayed.
Ship-avoiding operation	:	To operate the ship in order to avoid obstacles during automatic navigation, regardless of the scheduled route
Sleeping AIS target	:	A target indicating the presence and orientation of a vessel equipped with AIS
SOG	:	Speed Over the Ground
SP	:	Short Pulse
Spot depth	:	Numeric representation of depth
SSR: Solid State Radar	:	Radar that uses semiconductor elements instead of magnetron, which requires periodic replacement. It is built with a system that ensures necessary detection capability even when a transmission output is low,

by using chirp signals with a long pulse length upon transmission and performing pulse compression upon reception

STAB	:	STABilization
STW	:	Speed Through Water
TCS	:	Track Control Systems
TCPA	:	Time to Closest Point of Approach to own ship
TM	:	True Motion. A display across which the own ship and targets move with their own true motions.
To WPT	:	To Waypoint (To WPT)
Trails	:	Tracks displayed by the radar echoes of targets in the form of an afterglow
Trial maneuver	:	A graphical simulation facility used to assist the operator to perform a proposed maneuver for navigation and collision avoidance purposes
True vector	:	A vector representing the predicted true motion of a target, as a result of input of the course and speed of the own ship
TT	:	Target Tracking
TTG	:	Time To Go. Time to next waypoint.
TXRX	:	Transceiver Unit
UKHO	:	United Kingdom Hydrographic Office
Update (Chart Maintenance)	:	A procedure of reflecting the update data supplied by Update CD on the imported chart.
Update CD	:	Chart CD containing the chart data updated from Base CD. This can be used when Base CD data has been imported.
USER CODE	:	A user-specific code assigned by JRC. Required in using ARCS and S-63 charts.
UTC	:	Universal Time, Coordinated
VDR	:	Voyage Data Recorder
VRM	:	Variable Range Marker
WOL	:	Wheel Over Line
WOP	:	Wheel Over Point
WPT	:	Waypoint

WPT-WPT : The division of the leg specified by two points. Displays data between two consecutive waypoints.

XTD : Cross Track Distance

XTL : Cross Track Limit

How to Use This Manual

Structure of this manual

This manual is structured as shown below. Read the necessary section according to the purpose.

Item	Contents
Preface	Describes the purposes of using this equipment.
Safety Cautions Emergency Measures	Describes the cautions for a high voltage, precautions for rescue of victims of an electric shock, and the method of First-Aid treatment.
Pictorial Indication Precautions upon Equipment Operation	Describes the safety precautions and warning on this equipment.
The Mounting Point of the Warning Label	Describes the warning label attachment position on this equipment.
Equipment Appearance	Describes the appearance of this equipment.
Glossary	Describes the special terminologies and equipment-specific terminologies that are used in this manual.
How to use this manual	This page

<Basic Operation>

Section 1 Overview	Describes the overview of this equipment.
Section 2 Name and Function of Each Unit	Describes the name and function of each unit of this equipment.
Section 3 Common Basic Operations	Describes the common basic operations of ECDIS.
Section 4 Range and Bearing Measurement Methods	Describes the measuring methods of distance and bearing using the measuring tools.

<Function>

Section 5 Target Tracking and AIS	Describes the methods of using target tracking and AIS.
Section 6 Functions of the ECDIS	Describes the basic ECDIS operations.
Section 7 Route Planning	Describes route planning.
Section 8 Route Monitoring	Describes route monitoring.
Section 9 Monitoring a Dragging Anchor	Describes anchor monitoring.
Section 10 Automatic Sailing (Option)	Describes automatic sailing.

<Function>

Section 11 Operating a Chart	Describes chart operations.
Section 12 Creating a User Chart/ Updating a Chart	Describes creation of user charts and automatic chart updating.
Section 13 Logbook	Describes the logbook.
Section 14 Setting Up Screen View	Describes the detail setting of screen display.
Section 15 Setting Up Alerts	Describes the alert detail setting for avoiding dangers.
Section 16 Setting Up the Operation Mode	Describes the detail setting of the operation modes of this equipment.

<Reference>

Section 17 Adjusting and Setting Up Equipment (for Services)	Describes the equipment adjustments and setting that are performed by the maintenance engineers.
Section 18 Playing Back Data Recorded During Navigation [Playback]	Describes playback of the data recorded during sailing.
Section 19 Maintenance & Inspection	Describes the maintenance and inspection of this equipment.
Section 10 Failures and After-Sale Services	Describes the failure handling measures and aftercare services of this equipment.
Section 21 About Disposal	Describes the cautions on disposing of this equipment.
Section 22 Specifications	Describes the specification of this equipment.
Appendix A Alert List	Describes the alert list.
Appendix B Menu List	Describes the materials such as the menu list.



Notations

Operation notations

Trackball operations on the operation panel are expressed as follows.

Operation	Notation
Click the left button.	Click Example: Click on the object.
Double-click the left button.	Double-click Example: Determine the drawing by double-click.
Click the right button	Click the right mouse button Example: Display the context menu by clicking the right mouse button.

The buttons and dialog boxes on the screen are expressed as follows.

Button type	Notation
Button with button name indicated	Example:  → [AUTO] (automatic) button
Button with an indication other than the button name such as an icon	Shown as follows. Example:  → Day/Night button

A series menu selection operations is expressed as follows.

Click on [User Chart] - [Information Mark Property] - [Position] on the menu.

Contents

Basic Operation

Section 1	Overview.....	1-1
1.1	Functions.....	1-3
1.2	Features.....	1-5
1.3	Components.....	1-6
1.4	Structure.....	1-8
1.5	General System Diagrams.....	1-23
Section 2	Name and Function of Each Unit.....	2-1
2.1	Name and Main Function of the Operation Unit.....	2-1
2.1.1	Trackball operation unit.....	2-1
2.1.2	Keyboard operation unit (Option).....	2-2
2.1.3	Display unit.....	2-4
2.2	Names and Main Functions of the Top Screen.....	2-5
2.2.1	Task Switching Button.....	2-7
2.2.2	Right Toolbar.....	2-7
2.2.3	Left Toolbar.....	2-8
2.2.3.1	Buttons that are normally displayed.....	2-9
2.2.3.2	Buttons that are normally hidden.....	2-10
2.2.4	Alert notification area.....	2-10
2.2.5	Key assignment indication area.....	2-10
2.2.6	Own Ship Information.....	2-11
2.2.7	Chart Information Area (ENC/C-MAP).....	2-14
2.2.8	Chart Information Area (RNC).....	2-16
2.2.9	Sub Information Area.....	2-17
2.2.10	Bottom Bar (Sub Information Area).....	2-20
2.2.11	ARCS PIN input dialog box.....	2-22
2.3	Common Information Window.....	2-23
2.3.1	Information monitor windows.....	2-24
2.3.1.1	Target INFO.....	2-24
2.3.1.2	TT List.....	2-28
2.3.1.3	AIS List.....	2-28
2.3.1.4	AIS Detail INFO.....	2-29
2.3.1.5	Wind/Current.....	2-33
2.3.1.6	Conning.....	2-36
2.3.2	Information reference windows.....	2-39
2.3.2.1	Switching between a standard window and an extended window.....	2-40
2.3.2.2	AIS MSG Tray.....	2-42

2.3.2.3	NAVTEX.....	2-43
2.3.2.4	Active Alert.....	2-49
2.3.2.5	Alert History	2-50
2.3.2.6	AIS.....	2-51
2.3.2.7	Maintenance INFO	2-52
Section 3	Basic Operations	3-1
3.1	Powering On and Starting.....	3-1
3.2	Starting Each Mode.....	3-3
3.3	Basic Operations when using a Trackball.....	3-5
3.3.1	Basic trackball operations.....	3-5
3.3.2	Basic click operations	3-5
3.3.2.1	Selecting a button.....	3-5
3.3.2.2	Selecting a single object.....	3-5
3.3.2.3	Selecting multiple objects.....	3-6
3.3.3	Basic operations of double-clicking	3-6
3.3.4	Basic operations of clicking the right button	3-6
3.3.5	Displaying simplified information and operational guide of objects	3-7
3.3.6	Cursor types.....	3-8
3.4	Basic Menu Operations.....	3-10
3.4.1	Opening the menu	3-10
3.4.2	Menu list.....	3-13
3.4.3	Closing the menu.....	3-13
3.5	Basic Dialog Box Operations	3-14
3.5.1	Changing dialog box settings.....	3-14
3.5.2	Closing a dialog box.....	3-15
3.5.3	Title Bar	3-16
3.6	Operation of the Information Monitor Window	3-17
3.6.1	Opening the information monitor window	3-17
3.6.2	Displaying an information monitor window from other than the "Page Selection" dialog box.....	3-19
3.7	Confirming and Acknowledging an Alert	3-20
3.7.1	Stopping a buzzer.....	3-21
3.7.2	Confirming alert contents.....	3-21
3.7.3	Acknowledging the alert.....	3-23
3.7.4	Displaying alert list and alert history	3-24
3.8	Switching the Day/Night Mode.....	3-32
3.9	Adjusting the Brightness of the Screen and Operation Unit	3-34
3.9.1	Adjusting the Brightness of the Screen.....	3-34
3.9.2	Adjusting the Brightness of the Operation Unit.....	3-35
3.9.3	[Display Brightness] dialog box.....	3-36
3.10	Mouseover Display.....	3-37

3.10.1	Condition and timing of mouseover display	3-38
3.10.1.1	Starting mouseover display	3-38
3.10.1.2	Terminating mouseover display	3-39
3.10.2	How to read mouseover display	3-40
3.10.2.1	Example of mouseover display	3-40
3.10.2.2	Mouseover display of an AIS target/tracking target.....	3-40
3.10.2.3	Mouseover display of a buoy/light.....	3-41
3.11	MOB (Man Over Board)	3-43
3.12	Setting up the Timer	3-46
3.12.1	Setting up the timer.....	3-46
3.12.2	Setting up the time	3-46
3.13	Electronic Bearing Line (EBL) and Variable Range Marker (VRM)	3-47
3.13.1	Electronic Bearing Line (EBL) and Variable range marker (VRM)	3-47
3.13.2	Displaying the EBL and VRM buttons.....	3-48
3.13.3	Basic manipulation of EBL/VRM.....	3-50
3.13.3.1	Switching the control right of EBL/VRM	3-50
3.13.3.2	Setting up the measurement starting points.....	3-51
3.13.3.3	Setting the EBL bearing to True/Relative display	3-51
3.13.3.4	Setting up the range unit of VRM	3-52
3.13.3.5	Operating the intersecting point between EBL and VRM.....	3-52
3.14	Cursor AUTO Mode.....	3-53
3.14.1	No object.....	3-54
3.14.2	AIS	3-54
3.14.3	TT.....	3-55
3.14.4	(AZ) Acquisition/Activation Zone.....	3-56
3.14.5	AIS filter	3-57
3.14.6	User chart	3-58
3.14.6.1	Non-selected object.....	3-58
3.14.6.2	Selected object	3-58
3.14.7	Mariner's Mark/Line	3-63
3.14.7.1	Object in the non-selected state.....	3-63
3.14.7.2	Object in selected state	3-63
3.14.8	Manual updating	3-64
3.14.8.1	Unsaved object.....	3-64
3.14.8.2	Saved object.....	3-64
3.14.8.3	C-MAP chart	3-64
3.14.9	Buoy object	3-65
3.14.10	Light object.....	3-65
3.14.11	EBL	3-65
3.14.12	VRM	3-65
3.14.13	EBL/VRM intersecting point.....	3-65
3.14.14	Node Fixed EBL/VRM.....	3-65
3.14.15	PI.....	3-66

3.14.16	WPT of Monitored Route	3-66
3.14.17	Monitoring dragging anchor	3-66
3.14.17.1	Object in the unselected state	3-66
3.14.17.2	Selected state	3-66
3.14.18	Planned route	3-67
3.15	Saving the screen that is currently displayed	3-69
3.16	[MULTI] Dial	3-70
3.16.1	Functions of [MULTI] dial	3-70
3.16.2	Functions assigned to [MULTI] dial	3-70
3.16.2.1	Displaying a screen for setting the function that is assigned	3-70
3.16.2.2	Changing the function that is assigned	3-70
3.17	Basic Operations of the Software Keyboard	3-72
3.17.1	Starting a software keyboard	3-72
3.17.2	Name and function of each section of the keyboard	3-73
3.17.3	Numeric value input example	3-76
3.17.4	Character input example	3-78
3.18	Setting a Date and a Time (Calendar Operation)	3-80
3.18.1	Details and usage of a calendar picker and a time picker	3-81
3.18.1.1	Details of a calendar	3-81
3.18.1.2	How to use a calendar	3-82
3.19	Help	3-83
3.20	Password Input	3-86
3.21	Managing Files with File Manager	3-88
3.21.1	Displaying the [File Manager] dialog box	3-88
3.21.2	File management	3-89
3.21.3	Loading and saving files	3-92
3.21.3.1	Loading files	3-92
3.21.3.2	Saving files	3-94
3.21.3.3	Deleting data	3-95
3.22	Returning to a Task Menu by Ending the Operation	3-96
3.23	Terminating this equipment	3-98
3.24	Using a DVD Drive	3-99
Section 4	Range and Bearing Measurement Methods.....	4-1
4.1	List of Measuring Tools	4-1
4.2	Target Position	4-2
4.3	Using the Cross-hair Cursor	4-3
4.3.1	Cursor readout information area display position	4-3
4.3.2	Measuring the bearing and the range from the own ship's position to the target by using the cross-hair cursor	4-4
4.3.2.1	Switching the cursor bearing between True/Relative	4-5
4.3.2.2	Switching the cursor range unit	4-5

4.4	Using the Range Rings	4-6
4.5	Using the Electronic Bearing Line (EBL) and Variable Range marker (VRM)	4-8
4.5.1	Measuring a range and a bearing with EBL and VRM	4-8
4.5.1.1	Measuring in the trackball operation unit.....	4-8
4.5.1.2	Measuring with the [EBL] or [VRM] dial on the keyboard operation unit.....	4-9
4.5.2	Measuring between arbitrary two points	4-12
4.5.3	Manipulating EBL/VRM with the context menu	4-14
4.5.3.1	Manipulating EBL/VRM with [Dropped EBL/VRM] - [Make EBL1/VRM1] or [Make EBL2/VRM2]	4-15
4.5.3.2	Manipulating EBL with [Dropped EBL/VRM] - [Make EBL1] or [Make EBL2]	4-17
4.5.3.3	Manipulating VRM with [Dropped EBL/VRM] - [Make VRM1] or [Make VRM2]... ..	4-17
4.5.3.4	Manipulating EBL/VRM with [Dropped EBL/VRM] - [Move base point of EBL1/VRM1] or [Move base point of EBL2/VRM2]	4-17
4.5.3.5	Manipulating EBL/VRM with [CCRP EBL/VRM] - [Make EBL1/VRM1] or [Make EBL2/VRM2]	4-18
4.5.3.6	Manipulating EBL with [CCRP EBL/VRM] - [Make EBL1] or [Make EBL2]	4-19
4.5.3.7	Manipulating VRM with [CCRP EBL/VRM] - [Make VRM1] or [Make VRM2]	4-19
4.6	Using Parallel Index Lines (PI).....	4-20
4.6.1	Description of a parallel index line	4-20
4.6.2	Displaying parallel index lines.....	4-20
4.6.2.1	Displaying parallel index lines in the trackball operation unit.....	4-20
4.6.2.2	Displaying parallel index lines in the keyboard operation unit.....	4-21
4.6.2.3	Description of the [PI Menu] dialog	4-21
4.6.3	Setting all the parallel index lines concurrently (All mode)	4-24
4.6.3.1	Changing the bearing/interval of parallel index lines in the trackball operation unit (All mode)	4-26
4.6.4	Setting parallel index lines individually (Individual mode).....	4-27
4.6.4.1	Changing the bearing/interval/end point of parallel index lines in the trackball operation unit (Individual mode)	4-30
4.6.5	Displaying lines at equal interval on the left and right sides of the own ship's position (Track mode)	4-31
4.6.5.1	Changing the bearing/interval of parallel index lines with the trackball (Track mode).....	4-33
4.6.6	Displaying two intersecting lines (Equiangular mode).....	4-34
4.6.6.1	Changing the bearing of two intersecting lines in the trackball operation unit (Equiangular mode)	4-35
4.6.7	Setting parallel index lines in the keyboard operation unit	4-36
4.6.7.1	Operation in All mode	4-36
4.6.7.2	Operation in Individual mode.....	4-37
4.6.7.3	Operation in Track mode	4-37
4.6.7.4	Operation in Equiangular mode.....	4-38
4.7	Using the EBL Maneuver	4-39
4.7.1	Displaying the [EBL Manoeuvre Setting] dialog box.....	4-39

4.7.2	Clearing the display of maneuver curve	4-40
4.7.3	Setting the creation conditions of the EBL Maneuver.....	4-40
4.7.4	Creating an EBL manoeuvre curve.....	4-41
4.8	Connecting Own Ship and the Specified Fixed Position with EBL and the VRM Marker (Node Fixed EBL/VRM Function).....	4-43
4.8.1	Displaying the [Node Fixed EBL/VRM] dialog box	4-43
4.8.2	Description of [Node Fixed EBL/VRM] dialog box	4-44
4.8.3	Creating a new Node Fixed EBL/VRM	4-44
4.8.4	Cancelling the Node Fixed EBL/VRM function	4-45
4.9	Measuring the Own Ship's Position Manually (LOPs Fixing Function of Manual position fix).....	4-46
4.9.1	Displaying the [Manual Position Fix] dialog box	4-46
4.9.2	Description of the [LOPs Fixing] tab of the [Manual Position Fix] dialog box	4-47
4.9.3	Creating LOP	4-50
4.9.3.1	Creating bearing LOP.....	4-50
4.9.3.2	Creating distance LOP	4-52
4.9.4	Measuring the own ship's position in cross bearing fix.....	4-53
4.9.4.1	Automatic position fixing.....	4-54
4.9.4.2	Automatic offset.....	4-55
4.9.4.3	Manual position fixing	4-57
4.9.4.4	When there are three or more LOPs or TPLs	4-58
4.9.4.5	Setting a plotted position	4-60
4.9.5	Measuring the own ship's position with Running Fix	4-61
4.9.6	Measuring the own ship's position with other methods	4-65
4.10	Offsetting the Own Ship's Position Manually (Position Offset Function of Manual position fix).....	4-66
4.10.1	Displaying the [Manual Position Fix] dialog box	4-66
4.10.2	Description of the [Position Offset] tab of the [Manual Position Fix] dialog box	4-68
4.10.3	Setting the offset amount that is input in the [Enter Offset] dialog as the offset position.....	4-69
4.10.4	Setting the position on the chart on which the mouse button was clicked as the offset position.....	4-70
4.10.5	Recording LOPs Fixing operation in the logbook	4-71
4.10.6	Offsetting the own ship position.....	4-73

Section 1 Overview

WARNING



Do not put any container with water or small metallic object on this equipment. Water may spill or metal may enter the equipment, causing fire, electric shock or other troubles.



Should water or metal have entered the equipment, turn off the circuit breaker and contact our sales division, branch office, service center or representative located nearest to you.

If you continue to use the equipment without taking required action, fire, electric shock or other troubles may occur.



Should you find out smoke, offensive smell or extreme heat on the equipment, turn off the switch and circuit breaker immediately. Then contact our sales division, branch office, service center or representative located nearest to you.

If you continue to use the equipment without taking required action, fire or electric shock may occur.

CAUTION



Do not use or leave the equipment where there is a direct sunshine and high humidity or the temperature exceeds 55°.

Otherwise, fire or other troubles may occur.



Do not block the ventilation port of the equipment.

Otherwise, fire or other troubles may be caused by heat accumulation.



Use this equipment as your navigation aid.

- If you install two ECDIS's without backup system, be sure to use the specified marine chart for your navigational decision.
- This equipment does not provide automatic decision on the positional information. Decision on the positional information must be made by the ship operator himself. A trouble will occur if checkup is neglected.



Do not touch the equipment when your hands or gloves are wet with fresh water or seawater.

Otherwise, electric shock or other troubles may occur.

CAUTION



- Do not place any object on the operation panel.
In particular, if a hot object is placed on the operation panel, it can cause deformation of the surface of the operation panel.
- Do not apply any undue shock on the operation panel, trackball and dials.
Otherwise, a malfunction may result.



- When there is an alarm of fan failure or CPU temperature rise, turn off the power immediately.
If you continue to use the equipment without taking required action, fire or other troubles may occur.
Contact our sales division, branch office, service center or representative located nearest to you.

1.1 Functions

Electronic Chart Display and Information System (referred to as "this equipment" or "ECDIS" in this manual) is navigation equipment that satisfies the following IMO performance standards.

- IMO Resolution MSC232(82): Performance standards for electronic chart display and information systems (ECDIS)
- IMO Resolution MSC191(79): Performance standards for the presentation of navigation related information on shipborne navigational displays
- IMO Resolution MSC74(69): Annex 2: TCS*¹ performance standards
- IMO Resolution A.694(17): General requirements for shipborne radio equipment
- IMO Resolution MSC302(87): Bridge alert management

*1: Case where the TCS function is added as an option

This equipment is ECDIS that BOTH complies with the revised IHO standard S-52 Ed.6.1 and S-52 Presentation Library Ed. 4.0.1 AND satisfies the currently valid IHO standards defined in IHO's website (https://www.iho.int/mtg_docs/enc/ECDIS-ENC_StdIn_Force.htm). The software version of this equipment that satisfies these IHO standards can be confirmed on the JRC website (http://www.jrc.co.jp/eng/product/marine/application/ecdis_version.html) or directly on this equipment.

Any of the following task functions can be added to this equipment as the option, enabling the equipment to be used as a multi-function display.

- RADAR
- Conning Display
- The following databases can be displayed
 - S-57 Ed3.0/3.1
 - S-63
 - C-Map Ed3.0 Professional/Professional+
 - C-Map ENC
 - C-Map CAES
 - Jeppesen PRIMAR ECDIS Service
 - ARCS
- Own ship's track display and planned-route display on the electronic chart
- Automatic checking of the safety contours and dangerous areas of the own ship (not available for ARCS)
- Tracked target display and AIS target display on the electronic chart
- Overlay of radar echo on the electronic chart (when ECDIS is used with the optional radar interface board)
- True/Relative motion display
- North-up/Course-up/Head-up/Waypoint-up display
- Display of route information such as latitude/longitude at destinations, bearings/ranges up to waypoints, and planned arrival time
- Availability of two EBLs/VRMs
- Writing of memos with alphabetic characters into the electronic chart
- Display of information such as the date/time, current position, heading, and ship's speed

-
- Selection of colors (conforming to the IMO/IHO) suitable for the daytime, nighttime, dawn and evening
 - Editing of route information
 - Addition, deletion, and modification of WPTs on the electronic chart or the list
 - Calculation of the distance between WPTs, bearings, and planned arrival time
 - Up to 512 WPTs per route
 - Checking on the crossing of the safety contours and dangerous areas on created routes
 - Route tracking (option)

 - Course change
 - Safety contours crossing alarm
 - Dangerous areas approaching warning
 - Waypoint arrival warning
 - Off-track warning
 - Logging of navigation information onto the SSD
 - Own ship's playback using logged data

1.2 Features

This ECDIS has the following features:

- Minimizes the information that is displayed constantly and expands the chart display area.
- Can display vector charts (ENC and C-MAP) and raster chart (ARCS).
- Realizes safer sailing through the safety contour line, crossing danger areas, and guard ring function. (Excluding ARCS)
- Realizes high operability through high-speed drawing and high-speed processing.
- Facilitates creation of user charts.
- Applies a multi-display screen that can display two charts concurrently. (ARCS and C-MAP) Ed.3 cannot be displayed concurrently with a chart of a different type)
- Enables a course plan with multi-view.
- Can display a wide view screen while a single chart or multi-view is displayed.
- Enables creation of a route plan with the table editing function and the graphic editing function.
- Can create an alternative route while sailing.
- Automatic sailing is enabled by connecting with Auto Pilot. (option)
- The playback function enables checking of the sailed routes.
- The S-57 chart can be updated. (Chart Maintenance)
- Utilization of an icon menu
- Intuitive operation system based on the workflow
- High-resolution large screen
- Message reception notification function
Notifies arrival of a new AIS message and so on with a badge.
- Utilization of a common information window
Enables display of target information and simple conning information (wind direction/wind speed information etc.) with a simple switching operation.
- Display of chart information read results by grouping. Enables immediate access to the required information.
- Display of the cause of alert as well as the action guideline
- Equipped with the Help function
The built-in HTML Help enables the search of operation methods in this equipment instead of the hardcopy manual whenever required.
- Visual highlight of target symbols
Enables identification of the target that matches the condition such as the sailing direction, ship's length, and ship's type by highlighted display.
- Equipped with the white list type virus protection function of Trend Micro Incorporated

1.3 Components

A list of components and optional accessories is shown below.

Components of the Display Unit

Name		Model	Q'ty	Remarks
Display unit				Main unit
Display	(JMR-72XX/JAN-72XX)	NWZ-207 or NWZ-214	1	Included in the main unit.
	(JMR-92XX/JAN-92XX)	NWZ-208		
Trackball operation unit		NCE-5605	1	Included in the main unit.
Keyboard operation unit		NCE-5625	1	Option
Large tray		CWB-1593	1	Used only for a stand-alone display unit
UPS				Option
Buzzer unit		CGC-25	1	For TCS
Central control unit		NDC-1590/A	1	Included in the main unit.
	eToken	CYC-5025	1	Option for Jeppesen ENC service and Jeppesen Ed.3 Professional/+
Power supply unit		NBD-913	1	Included in the main unit.
Junction box		NQE-1143	1	Option
	Serial LAN I/F Interface circuit	CMH-2370	1	Option
	Analog Option circuit	CMJ-560	1	Option
	Gyro Interface circuit	CMJ-554	1	Option
	RADAR Interface circuit	CQD-2273	1	Option
Sensor LAN switch unit		NQA-2443/A	1	Option
26inch cradle frame		CWA-246	1	Option
19inch cradle frame		CWA-245	1	Option
26inch desktop frame		CWB-1595	1	Option
19inch desktop frame		CWB-1594	1	Option
19inch desktop frame		CWB-1659	1	Option
Operation unit desktop frame		CWB-1596	1	Option
Power control unit		NQE-3167	1	Option
Instruction Manual (Japanese)			1	
Instruction Manual (English)			1	
Installation Manual (Japanese)			1	Option
Installation Manual (English)			1	Option
Canvas cover			1	Option
Hood	(JMR-72XX/JAN-72XX)		1	Option

	(JMR-92XX/JAN-92XX)			
Accessory	CD cleaner		1	Packing in 1 box
Spare parts for the main unit			1	Packing in 1 box
Spare parts for the junction box			1	Option

1.4 Structure

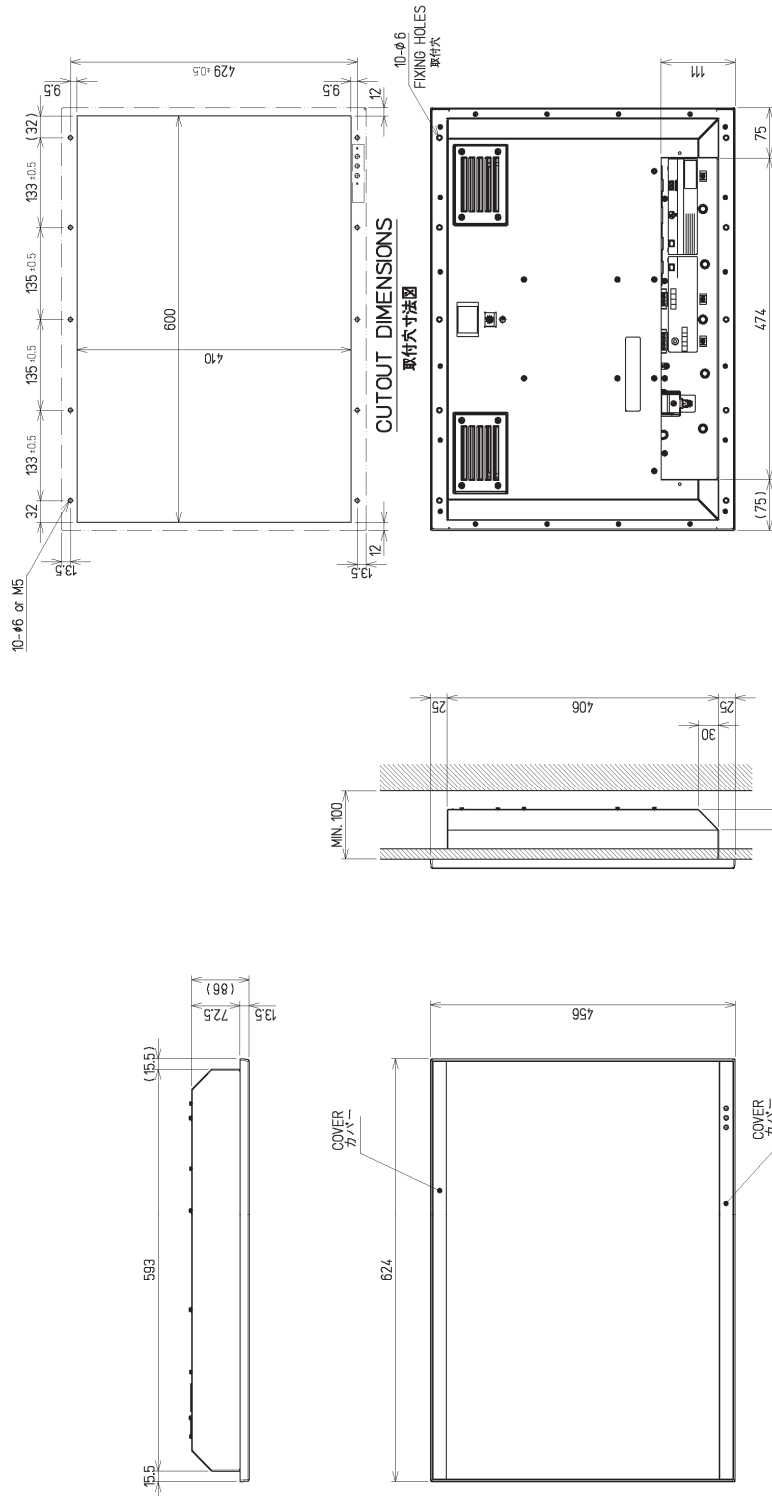

MASS	APPROX. 16 kg
UNIT	mm
質量	約 16 kg
単位	mm

外形寸法	外形寸法 許容差	取付寸法 許容差
全高さ	以下	
3	6	±0.5
6	30	±1
30	120	±1.5
120	600	±2.5
600	1000	±4
1000	2000	±6
2000	4000	±8

OUTLINE DIMENSIONS	PERMISSIBLE DIMENSIONAL DEVIATIONS	PERMISSIBLE DIMENSIONAL DEVIATIONS
OVER	TO	
3	6	±0.5
6	30	±1
30	120	±1.5
120	600	±2.5
600	1000	±4
1000	2000	±6
2000	4000	±8

NWZ-208

MONITOR UNIT OUTLINE DRAWING

SCNW5077

Outline drawing of 26inch Display (NWZ-208)

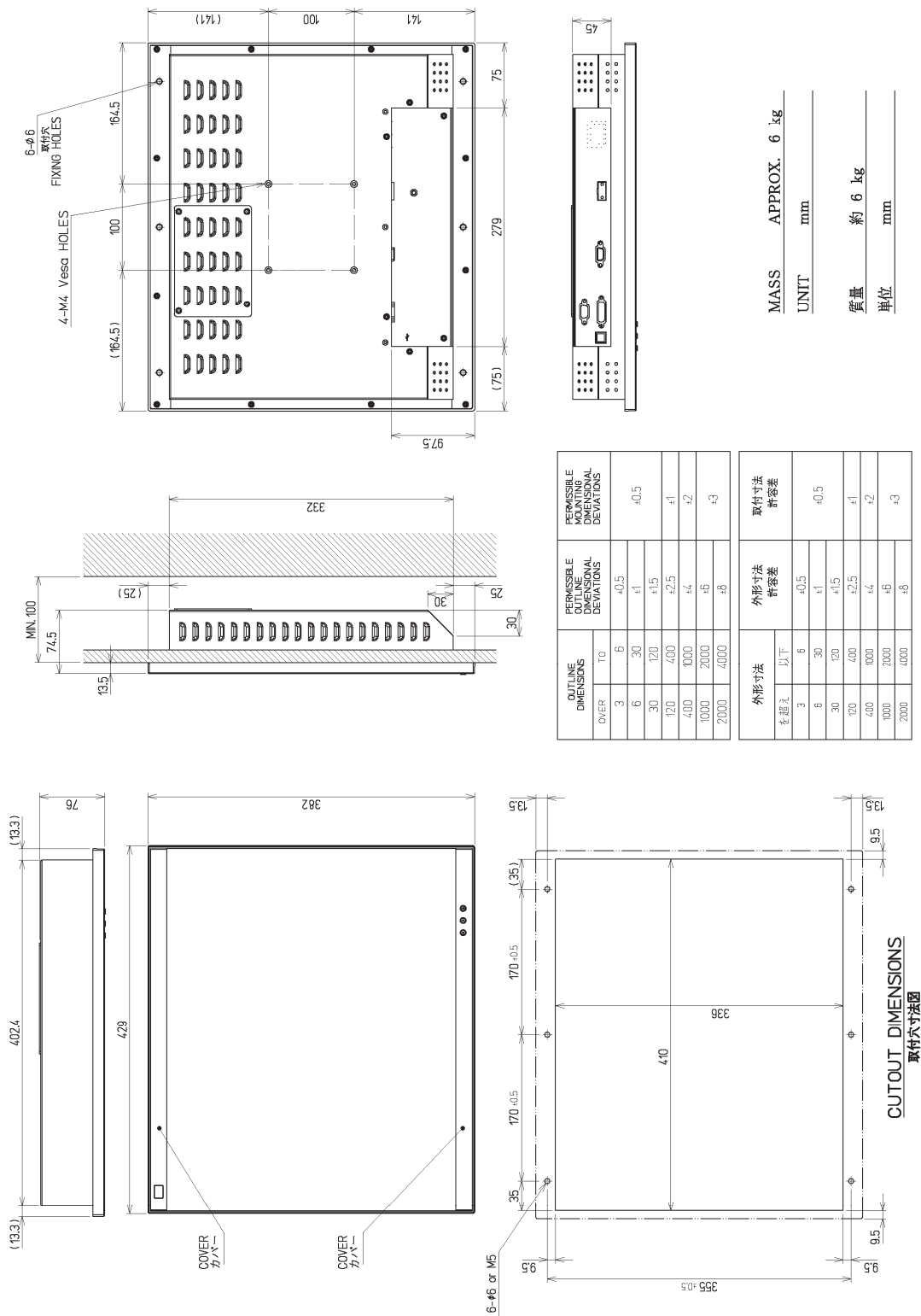

OUTLINE DIMENSIONS	PERMISSIBLE DIMENSIONAL DEVIATIONS		PERMISSIBLE DIMENSIONAL DEVIATIONS
	OVER	TO	
3	6	+0.5	
6	30	+1	±0.5
30	120	+1.5	
120	400	+2.5	±1
400	1000	+4	±2
1000	2000	+6	
2000	4000	+8	±3

外形寸法 寸法	外形寸法 許容差		取付寸法 許容差
	寸法	許容差	
3	6	+0.5	
6	30	+1	±0.5
30	120	+1.5	
120	400	+2.5	±1
400	1000	+4	±2
1000	2000	+6	
2000	4000	+8	±3

MASS APPROX. 6 kg
 UNIT mm
 質量 約 6 kg
 単位 mm

NWZ-207

MONITOR UNIT OUTLINE DRAWING

SCNWZ5078

Outline drawing of 19inch Display (NWZ-207)

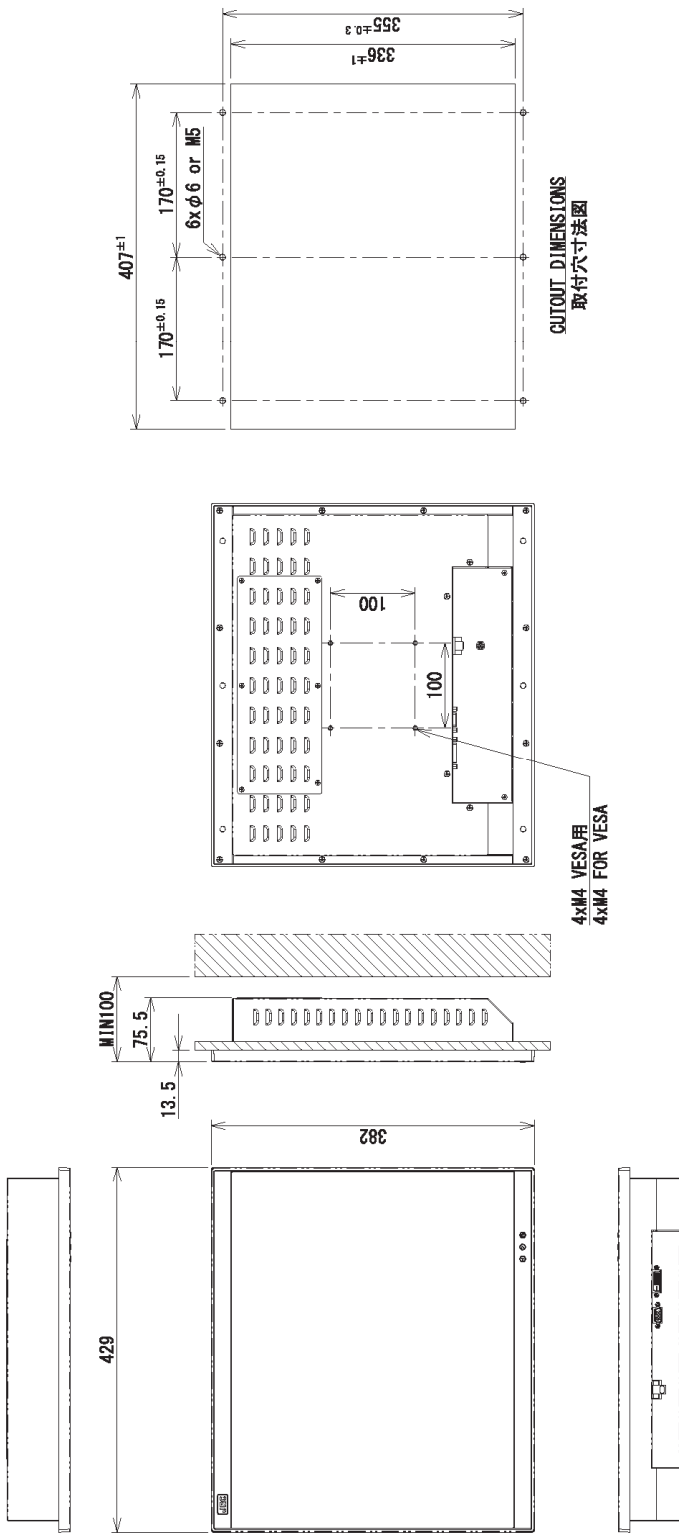

OUTLINE DIMENSIONS
取付寸法図

外形寸法 を越え	外形寸法 許容差		取付寸法 許容差
	以下		
3	6	±0.5	±0.5
6	30	±1	
30	120	±1.5	±1
120	400	±2.5	
400	1000	±4	±2
1000	2000	±6	
2000	4000	±8	±3

OUTLINE DIMENSIONS		PERMISSIBLE OUTLINE DIMENSIONAL DEVIATIONS	PERMISSIBLE MOUNTING DIMENSIONAL DEVIATIONS
OVER	TO		
3	6	±0.5	±0.5
6	30	±1	
30	120	±1.5	±1
120	400	±2.5	
400	1000	±4	±2
1000	2000	±6	
2000	4000	±8	±3

MASS APPROX. 4.6kg
UNIT mm
質量 約 4.6kg
単位 mm

NWZ-214

Outline drawing of 19inch Display (NWZ-214)

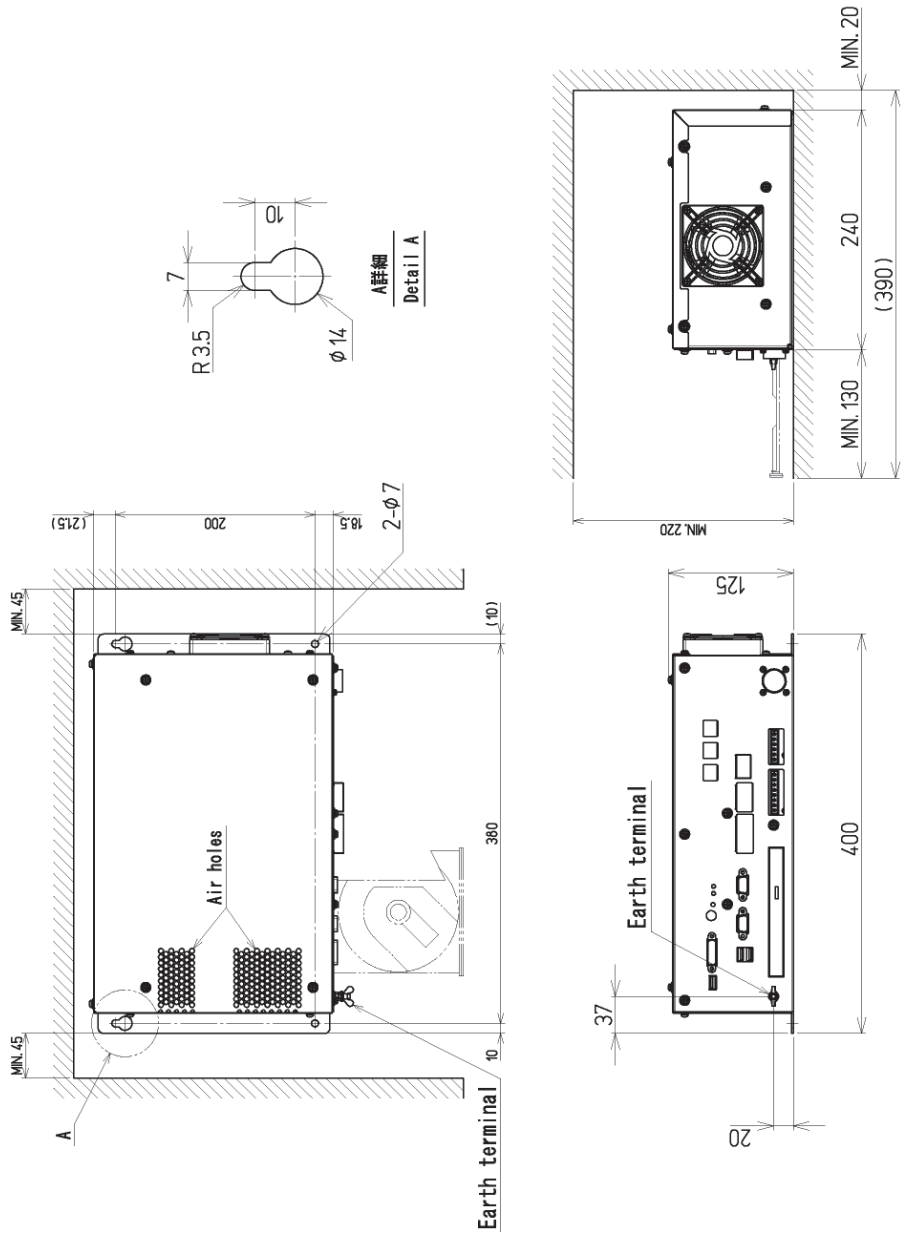

Outline Drawing of Central Control Unit (NDC-1590/A)

外形寸法		取付法 許容差
を 超え	以下	
3	6	±0.5
6	30	±1
30	120	±1.5
120	400	±2.5
400	1000	±4
1000	2000	±6
2000	4000	±8

OUTLINE DIMENSIONS		PERMISSIBLE MOUNTING DIMENSIONAL DEVIATIONS
OVER	T0	
3	6	±0.5
6	30	±1
30	120	±1.5
120	400	±2.5
400	1000	±4
1000	2000	±6
2000	4000	±8

MASS APPROX. 5.6 kg
UNIT mm

質量 約 5.6 kg
単位 mm

SCNDC5246-①

CENTRAL CONTROL UNIT OUTLINE DRAWING

NDC-1590/A

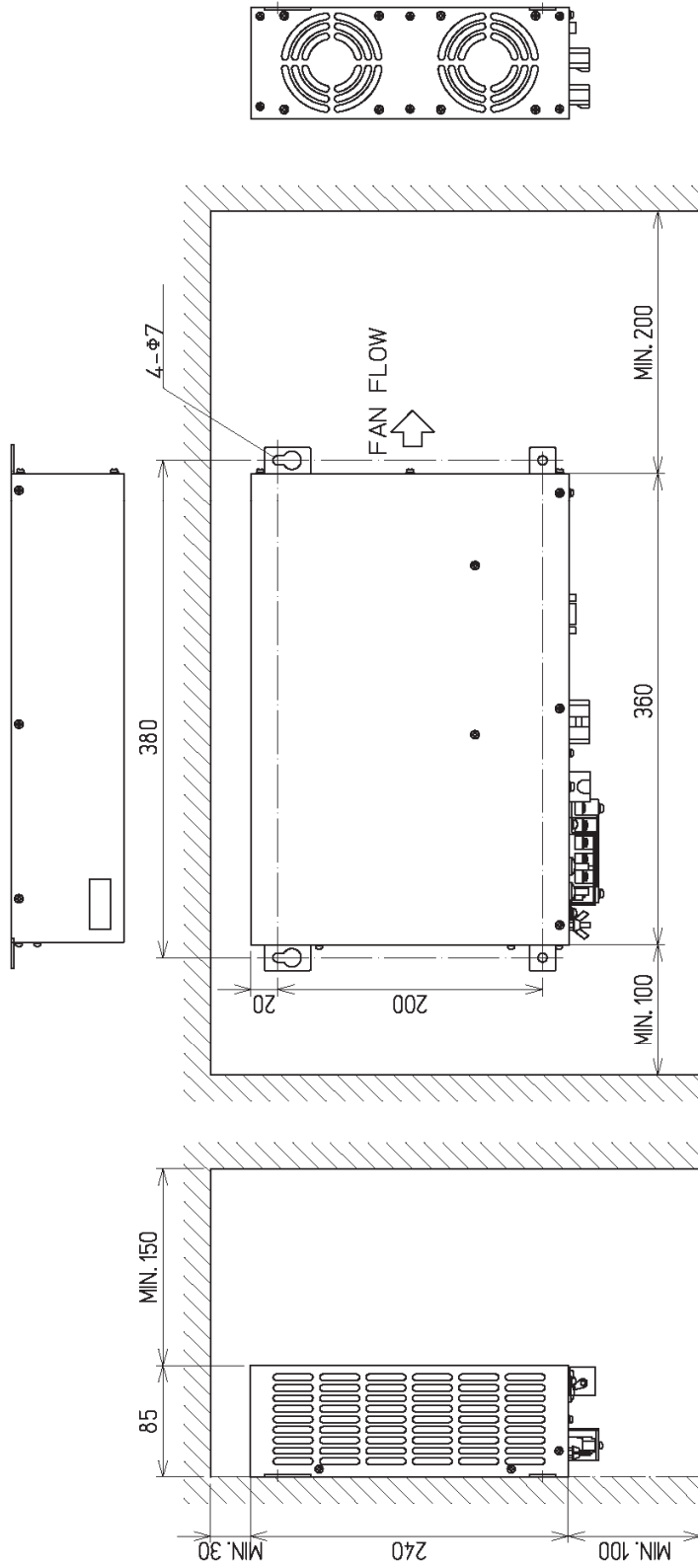

Outline Drawing of Power Supply Unit (NBD-913)

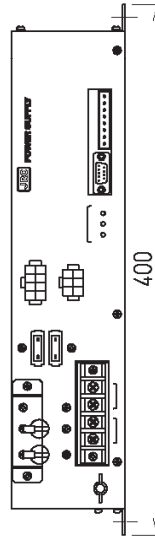

MASS APPROX. 4.2 kg

UNIT mm

質量 約 4.2 kg

単位 mm

外形寸法 公差	外形寸法 許容差		取付寸法 許容差
	公差	以下	
3	6	+0.5	±0.5
6	30	±1	
30	120	±1.5	±1
120	400	±2.5	
400	1000	±4	±2
1000	2000	±6	
2000	4000	±8	±3

OUTLINE DIMENSIONS		PERMISSIBLE OUTLINE DIMENSIONAL DEVIATIONS	PERMISSIBLE OUTLINE DIMENSIONAL DEVIATIONS
OVER	TOL		
3	6	+0.5	±0.5
6	30	±1	
30	120	±1.5	±1
120	400	±2.5	
400	1000	±4	±2
1000	2000	±6	
2000	4000	±8	±3

SCNBD5067

POWER SUPPLY UNIT OUTLINE DRAWING

NBD-913

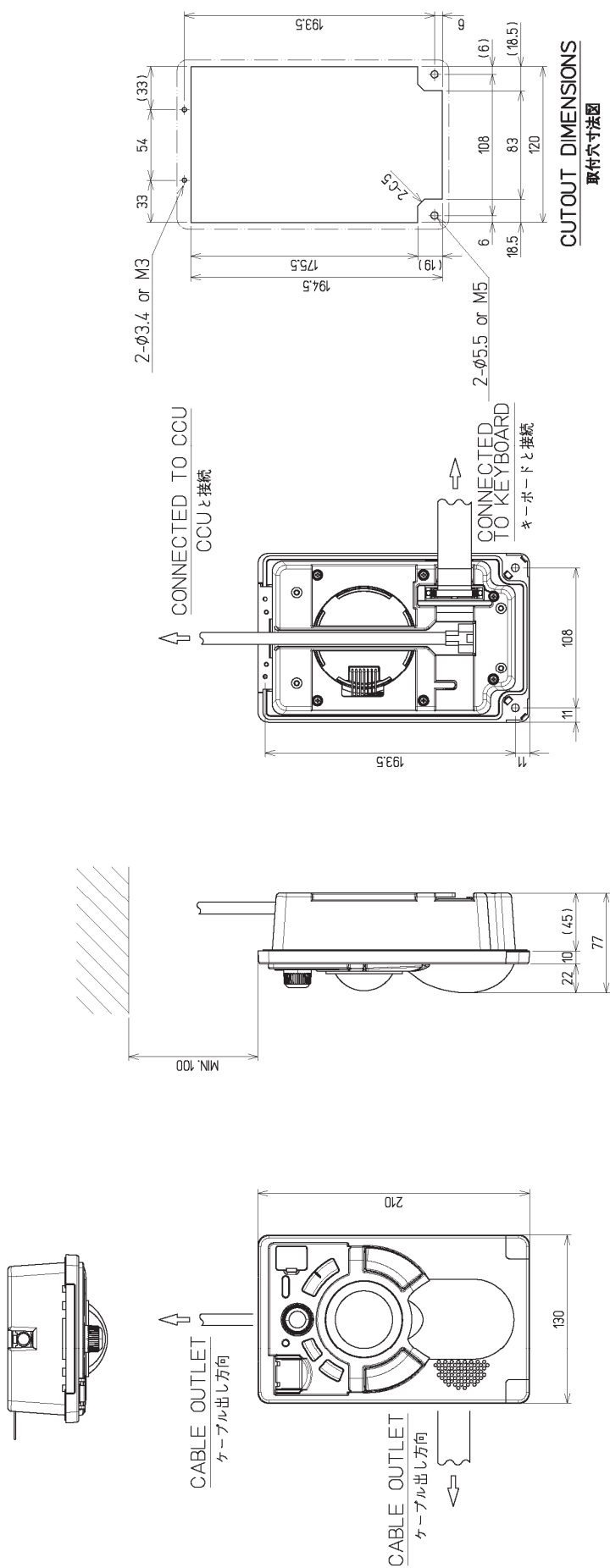

CUTOUT DIMENSIONS
取付穴寸法図

外形寸法 を越え	外形寸法 許容差		取付寸法 許容差
	以下		
3	6	+0.5	±0.5
6	30	+1	
30	120	+1.5	±1
120	400	+2.5	
400	1000	+4	±2
1000	2000	+6	
2000	4000	+8	±3

OUTLINE DIMENSIONS		PERMISSIBLE MOUNTING DIMENSIONAL DEVIATIONS	PERMISSIBLE OUTLINE DIMENSIONAL DEVIATIONS
OVER	TO		
3	6	+0.5	+0.5
6	30		
30	120	+1	+1
120	400		
400	1000	+2	+2
1000	2000		
2000	4000	+3	+3

MASS	APPROX. 1.3 kg
UNIT	mm
質量	約 1.3 kg
単位	mm

SONCE5367

TRACKBALL OPERATION UNIT OUTLINE DRAWING

NCE-5605

Outline Drawing of Trackball Operation Unit (NCE-5605)

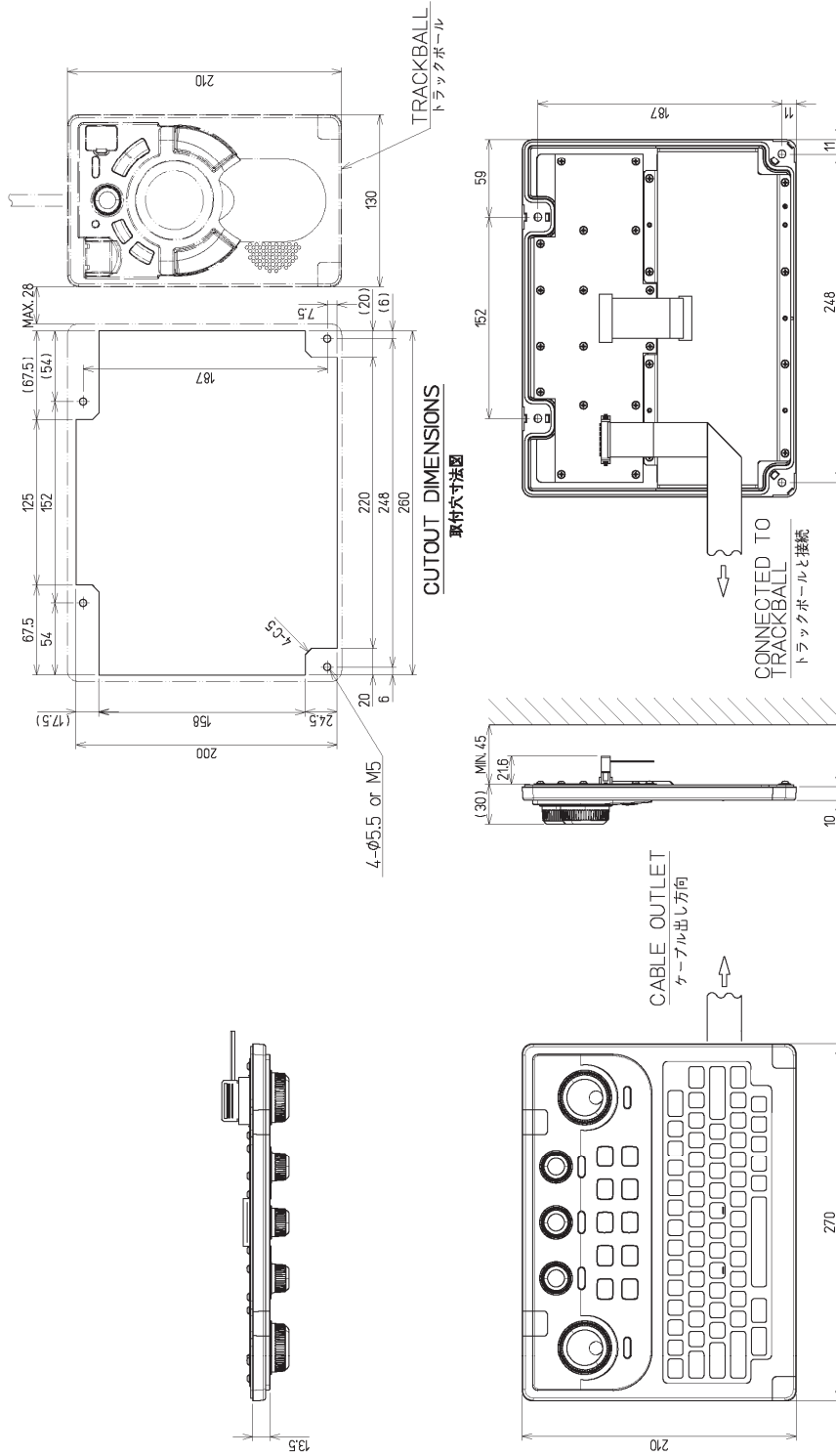

MASS APPROX. 0.8 kg
 UNIT mm
 質量 約 0.8 kg
 単位 mm

外形寸法 を越え	外形寸法 許容差		取付寸法 許容差
	以下	以上	
3	6	±0.5	±0.5
6	30	±1	
30	120	±1.5	±1
120	400	±2.5	
400	1000	±4	±2
1000	2000	±6	±3
2000	4000	±8	

OUTLINE DIMENSIONS		PERMISSIBLE DIMENSIONAL DEVIATIONS	PERMISSIBLE DIMENSIONAL DEVIATIONS
OVER	10	±0.5	±0.5
3	6	±1	±1
6	30	±1.5	±1.5
30	120	±2.5	±1
120	400	±4	±2
400	1000	±6	±3
1000	2000	±8	
2000	4000		

SONCE5368

KEYBOARD OPERATION UNIT OUTLINE DRAWING

NCE-5625

Outline Drawing of Keyboard Operation Unit (NCE-5625)

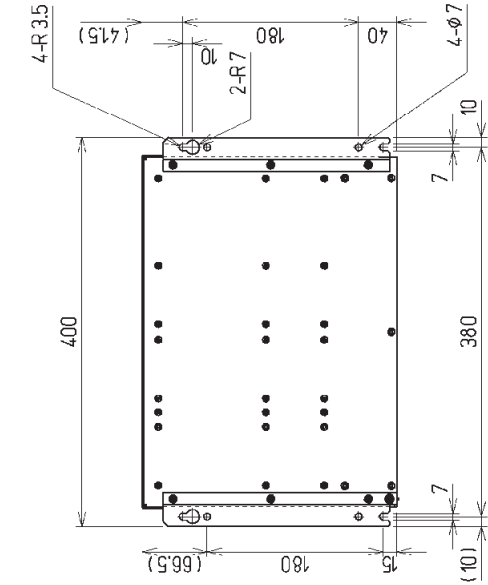
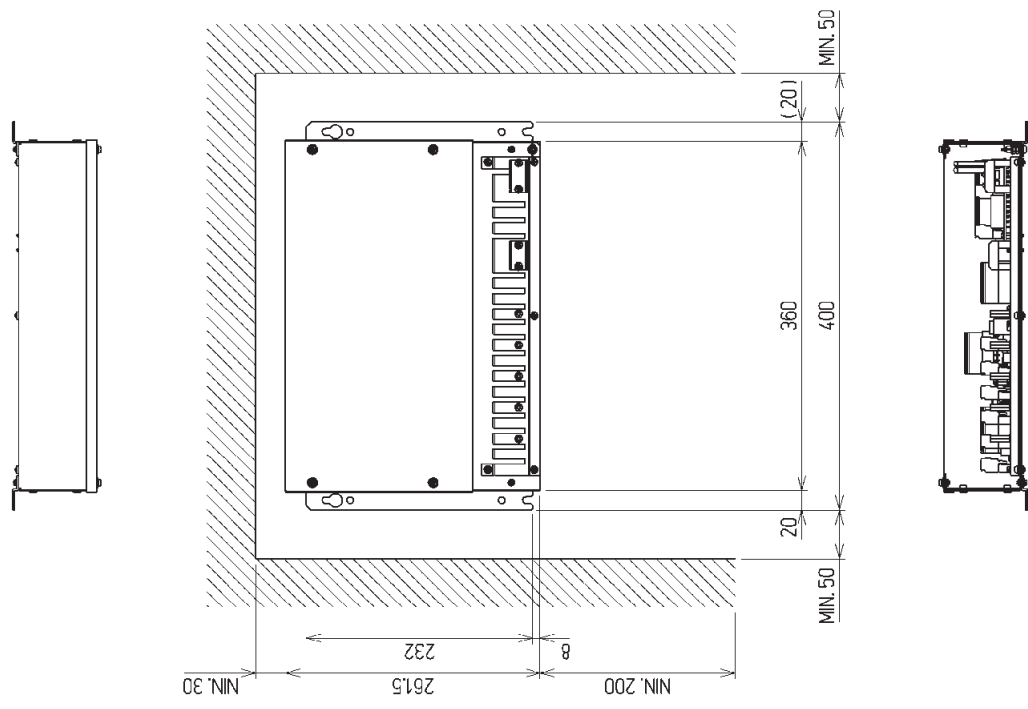

DIMENSIONS		DIMENSIONS RELATING TO MOUNTING DEVIATIONS		DIMENSIONS RELATING TO MOUNTING DEVIATIONS	
UNIT	mm	UNIT	mm	UNIT	mm
3	6	3	0.3	3	0.5
6	30	6	1.5	6	1.5
30	120	30	4.5	30	4.5
120	400	120	12.5	120	12.5
400	1000	400	40	400	40
1000	2000	1000	100	1000	100
2000	4000	2000	200	2000	200

DIMENSIONS		DIMENSIONS RELATING TO MOUNTING DEVIATIONS		DIMENSIONS RELATING TO MOUNTING DEVIATIONS	
UNIT	mm	UNIT	mm	UNIT	mm
3	0.05	3	0.05	3	0.05
6	0.1	6	0.1	6	0.1
30	0.5	30	0.5	30	0.5
120	2.5	120	2.5	120	2.5
400	10	400	10	400	10
1000	40	1000	40	1000	40
2000	100	2000	100	2000	100

MASS APPROX. 3.8 kg

UNIT mm

質量 約 3.8 kg

単位 mm

SCNQE5093-0

JUNCTION BOX OUTLINE DRAWING

NQE-1143

Outline Drawing of Junction Box (NQE-1143)

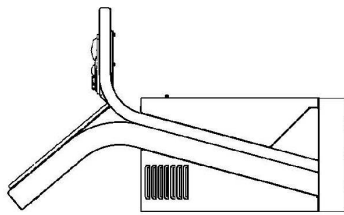
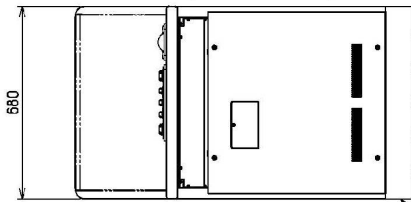
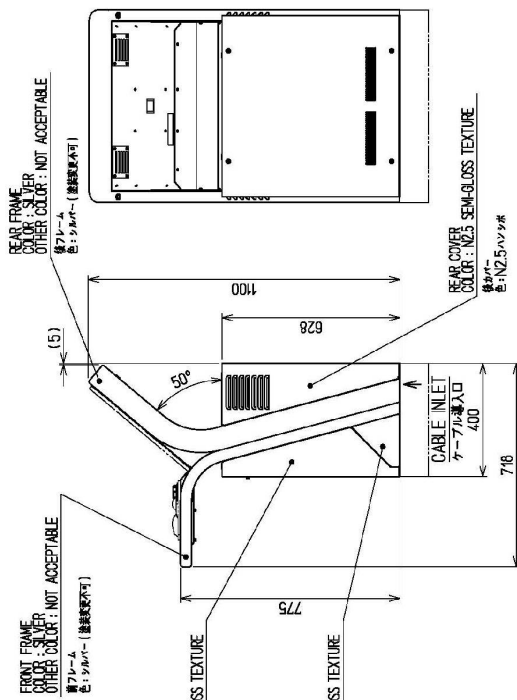
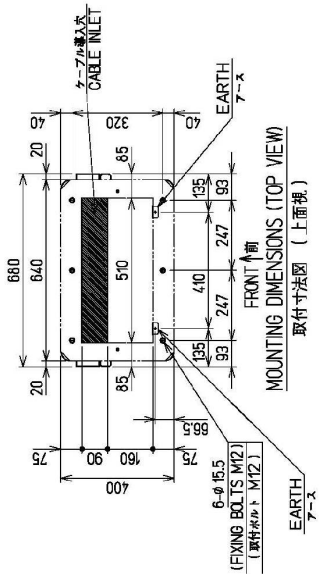
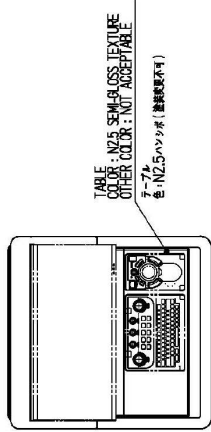
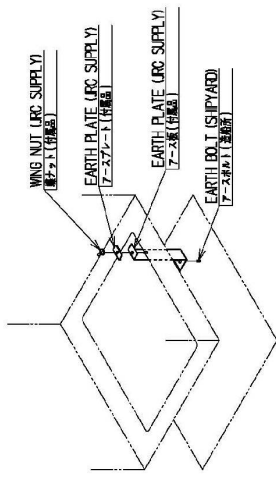

CHANNEL BASE
チャンネルベース

MASS	APPROX. 65 kg
MASS	APPROX. 100 kg (NCD-2272)
UNIT	mm
質量	約 65 kg
質量	約 100 kg (NCD-2272)
単位	mm

外形寸法 を起え	外形寸法 許容差		取付寸法 許容差
	以下		
3	6	±0.5	±0.5
6	30	±1	
30	120	±1.5	±1
120	400	±2.5	
400	1000	±4	±2
1000	2000	±6	
2000	4000	±8	±3

OUTLINE DIMENSIONS	PERMISSIBLE MOUNTING DIMENSIONAL DEVIATIONS		PERMISSIBLE OUTLINE DIMENSIONAL DEVIATIONS
	TO		
3	6	±0.5	±0.5
6	30	±1	
30	120	±1.5	±1
120	400	±2.5	
400	1000	±4	±2
1000	2000	±6	
2000	4000	±8	±3

Outline Drawing of 26inch Cradle Frame (CWA-246)
(with display, trackball operation unit and keyboard operation unit installed)

CWA-246

DISPLAY UNIT MOUNT KIT OUTLINE DRAWING

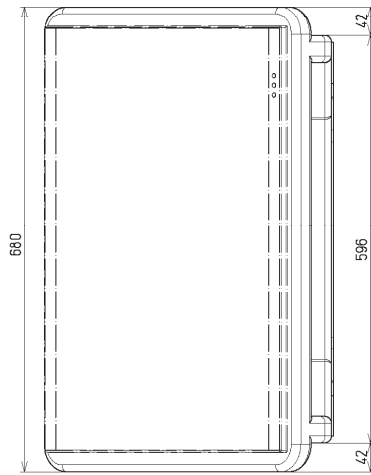
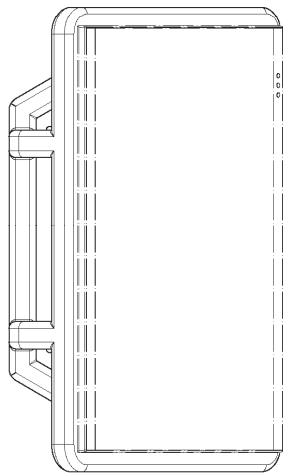

NWZ-208
MONITOR UNIT

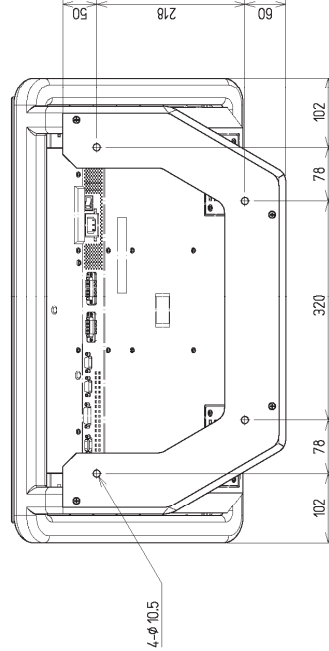
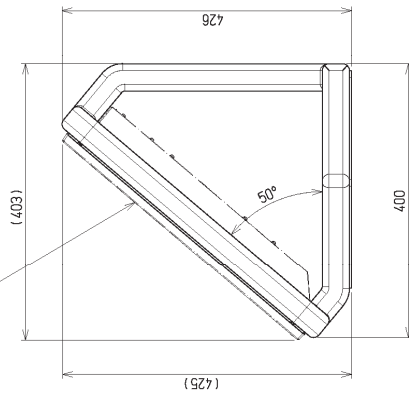

外形寸法 公差	外形寸法		外形寸法 公差	取付寸法 公差
	以下	以上		
3	6	6	±0.5	
6	30	30	±1	±0.5
30	120	120	±1.5	
120	400	400	±2.5	±1
400	1000	1000	±4	±2

OUTLINE DIMENSIONS OVER	TO	PERMISSIBLE DIMENSIONAL DEVIATIONS		PERMISSIBLE DIMENSIONAL DEVIATIONS	
		以下	以上	以下	以上
3	6	±0.5		±0.5	
6	30	±1			±0.5
30	120	±1.5			
120	400	±2.5		±1	
400	1000	±4		±2	

MASS	5.5 kg
UNIT	mm
質量	5.5 kg
単位	mm

Outline Drawing of 26inch Desktop Frame (CWB-1595)

SCYW05609

26 INCH DSKTOP FRAME OUTLINE DRAWING

CWB-1595

外形寸法		取付寸法 許容差
を超え	以下	
3	6	+0.5
6	30	+1
30	120	+1.5
120	400	+2.5
400	1000	+4
		+2

OUTLINE DIMENSIONS		PERMISSIBLE OUTLINE DIMENSIONAL DEVIATIONS	PERMISSIBLE MOUNTING DIMENSIONAL DEVIATIONS
OVER	TD		
3	6	+0.5	+0.5
6	30	+1	
30	120	+1.5	
120	400	+2.5	+1
400	1000	+4	+2

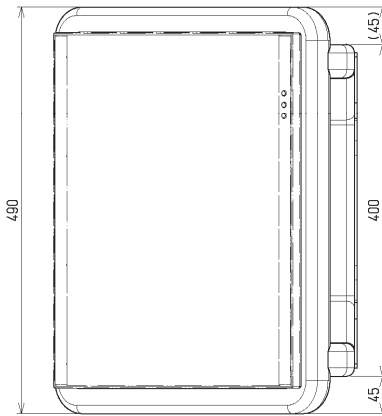
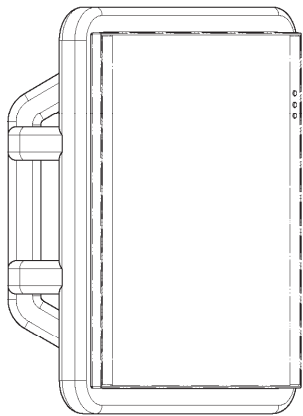

NWZ-207
MONITOR UNIT

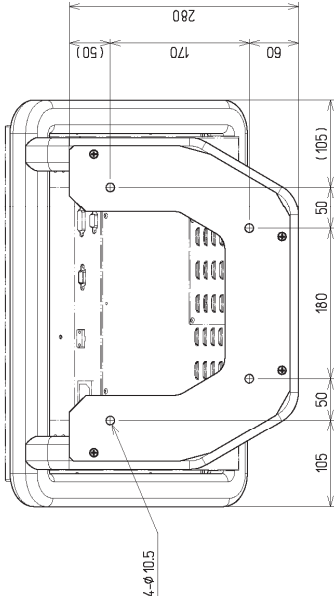
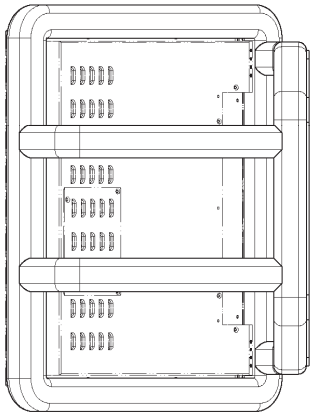
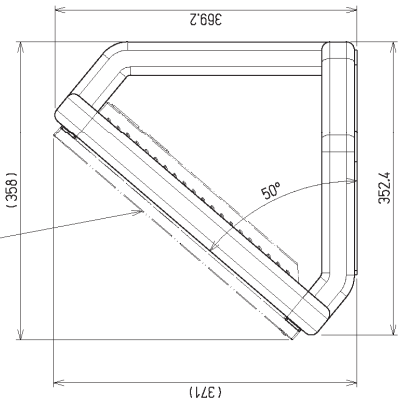

MASS APPROX. 3.6 kg
UNIT mm

質量 約 3.6 kg
単位 mm

Outline Drawing of 19inch Desktop Frame (CWB-1594)

SCYW05608

19 INCH DESKTOP FRAME OUTLINE DRAWING

CWB-1594

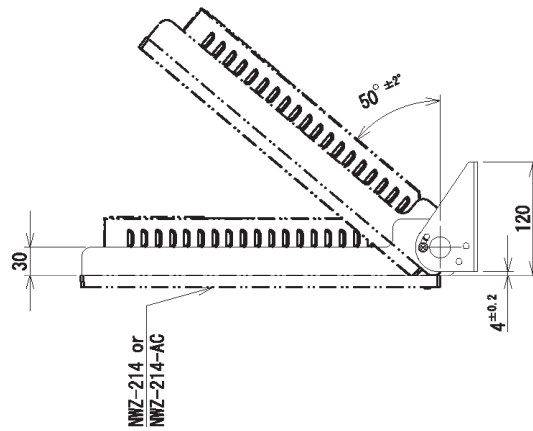
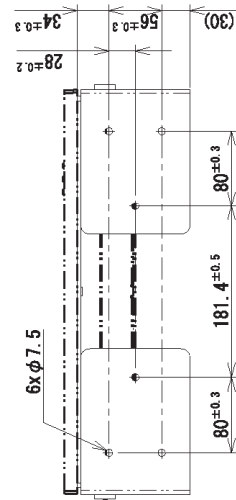
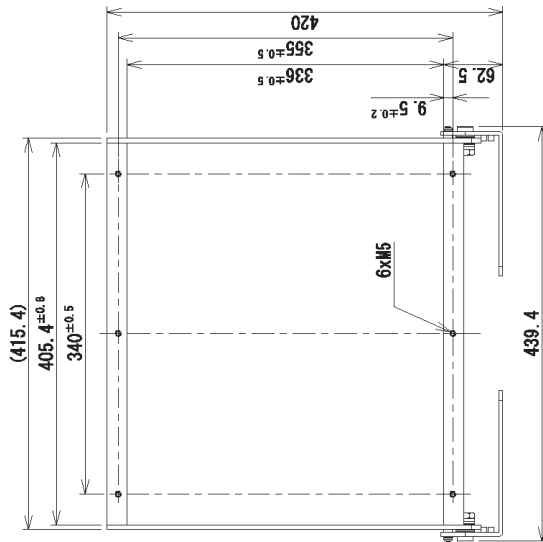
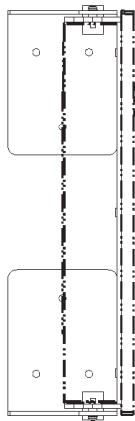

OUTLINE DIMENSIONS		PERMISSIBLE MOUNTING DIMENSIONAL DEVIATIONS	PERMISSIBLE MOUNTING DIMENSIONAL DEVIATIONS
OVER	TO		
3	6	±0.5	
6	30	±1	±0.5
30	120	±1.5	
120	400	±2.5	±1
400	1000	±4	±2
1000	2000	±6	±3
2000	4000	±8	

外形寸法		外形寸法許容差	取付寸法許容差
を 超 え	以 下		
3	6	±0.5	
6	30	±1	±0.5
30	120	±1.5	
120	400	±2.5	±1
400	1000	±4	±2
1000	2000	±6	±3
2000	4000	±8	

MASS APPROX. 1.2kg
 UNIT mm
 質量 約 1.2kg
 単位 mm

Outline Drawing of 19inch Desktop Frame (CWB-1659)

Outline Drawing of OPU Desktop Frame (CWB-1596)

外形寸法		外形寸法 許容差	取付寸法 許容差
を 超え	以下		
3	6	±0.5	±0.5
6	30	±1	
30	120	±1.5	
120	400	±2.5	±1
400	1000	±4	±2

OUTLINE DIMENSIONS		PERMISSIBLE OUTLINE DIMENSIONAL DEVIATIONS	PERMISSIBLE MOUNTING DIMENSIONAL DEVIATIONS
OVER	TO		
3	6	±0.5	±0.5
6	30	±1	
30	120	±1.5	
120	400	±2.5	±1
400	1000	±4	±2

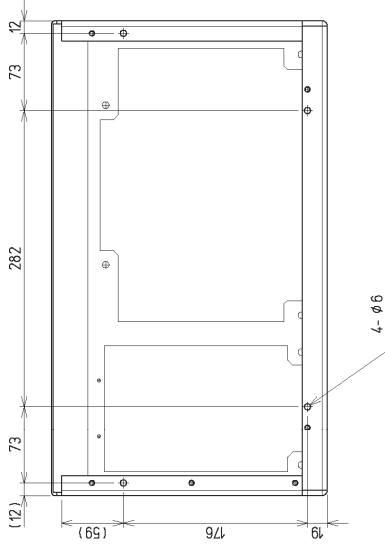
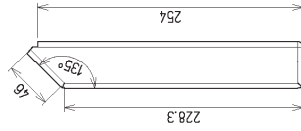
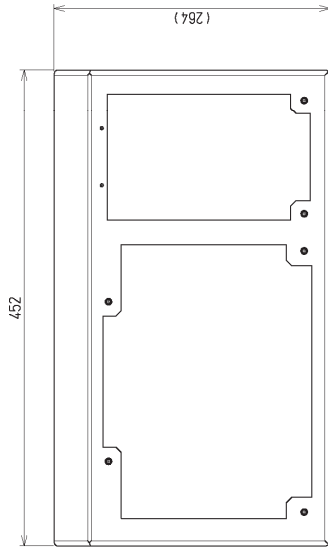

MASS APPROX. 1 kg
UNIT mm

質量 約 1 kg
単位 mm

SCYW05610

OPU DESKTOP FRAME

CWB-1596

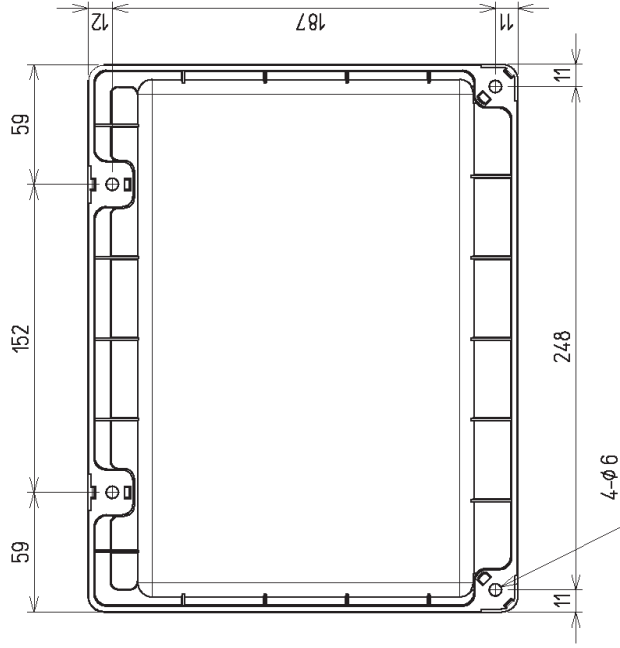
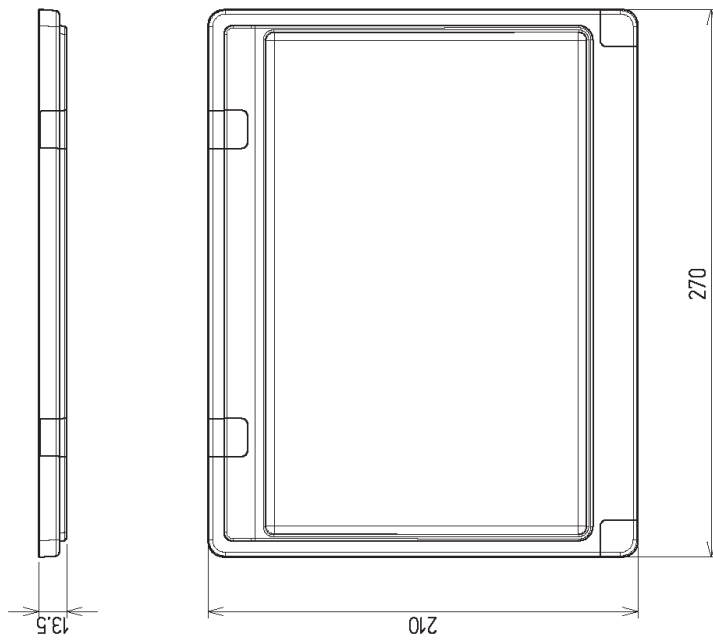

外形寸法 を 超え	外形寸法 許容差		取付寸法 許容差
	以下		
3	6	±0.5	±0.5
6	30	±1	±0.5
30	120	±1.5	±0.5
120	400	±2.5	±1
400	1000	±4	±2
1000	2000	±6	±3
2000	4000	±8	±3

OUTLINE DIMENSIONS		PERMISSIBLE OUTLINE DIMENSIONAL DEVIATIONS	PERMISSIBLE MOUNTING DIMENSIONAL DEVIATIONS
OVER	TO		
3	6	±0.5	±0.5
6	30	±1	±0.5
30	120	±1.5	±0.5
120	400	±2.5	±1
400	1000	±4	±2
1000	2000	±6	±3
2000	4000	±8	±3

MASS 0.3 kg

UNIT mm

質量 0.3 kg

単位 mm

Outline Drawing of Large Tray (CWB-1593)

1.5 General System Diagrams

Connection examples of this equipment are shown below.

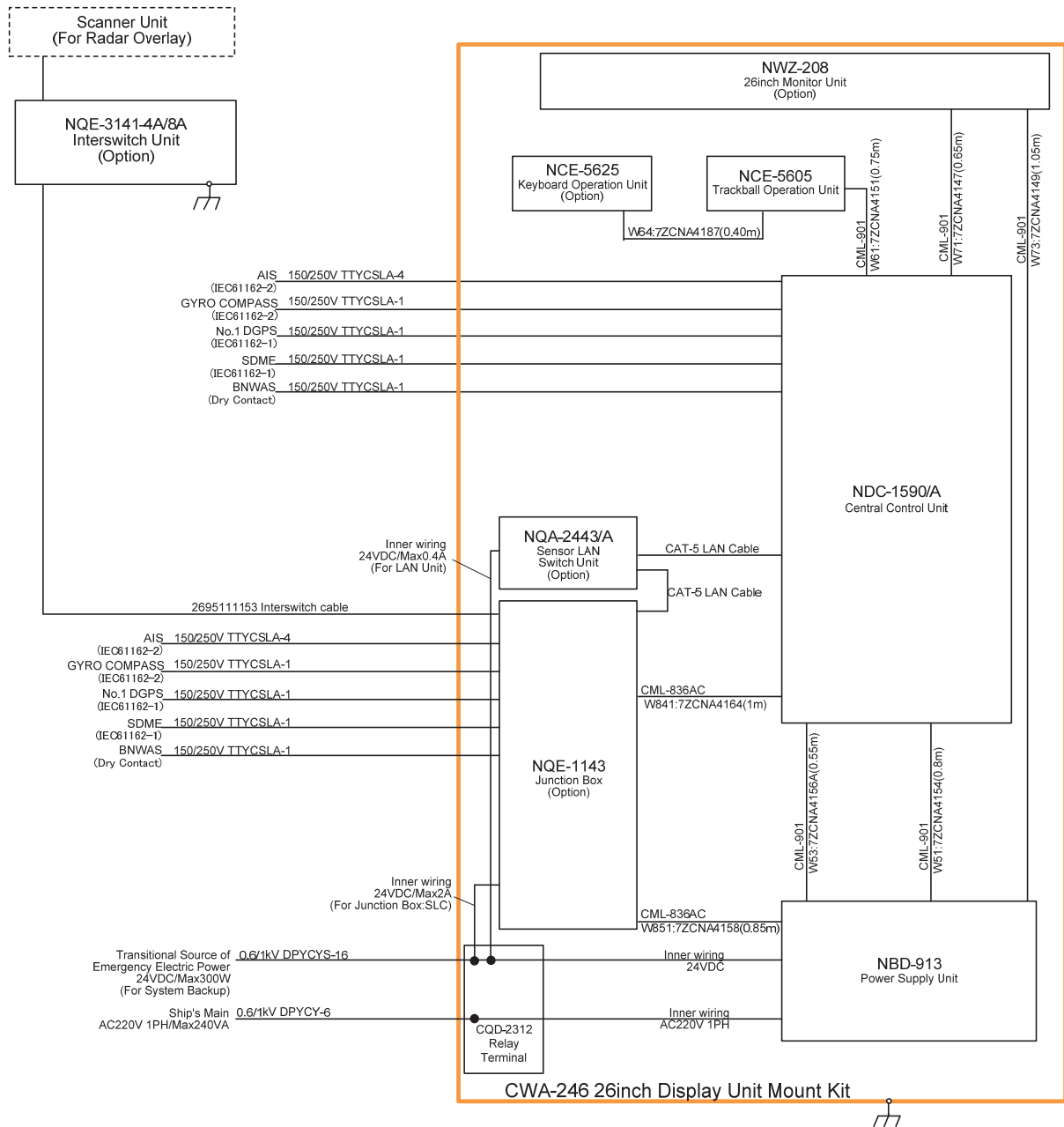

NOTE: ELIMINATING THE INTERFERENCE ON FREQUENCIES USED FOR MARINE COMMUNICATIONS AND NAVIGATION DUE TO OPERATION OF THE RADAR.
 ALL CABLES OF THE RADAR ARE TO BE RUN AWAY FROM THE CABLES OF RADIO EQUIPMENT.
 (ex. RADIOTELEPHONE, COMMUNICATIONS RECEIVER and DIRECTION FINDER, etc.)
 ESPECIALLY INTER-WIRING CABLES BETWEEN SCANNER UNIT AND DISPLAY UNIT OF THE RADAR SHOULD NOT BE RUN PARALLEL WITH THE CABLES OF RADIO EQUIPMENT.

General System Diagram of JAN-9201

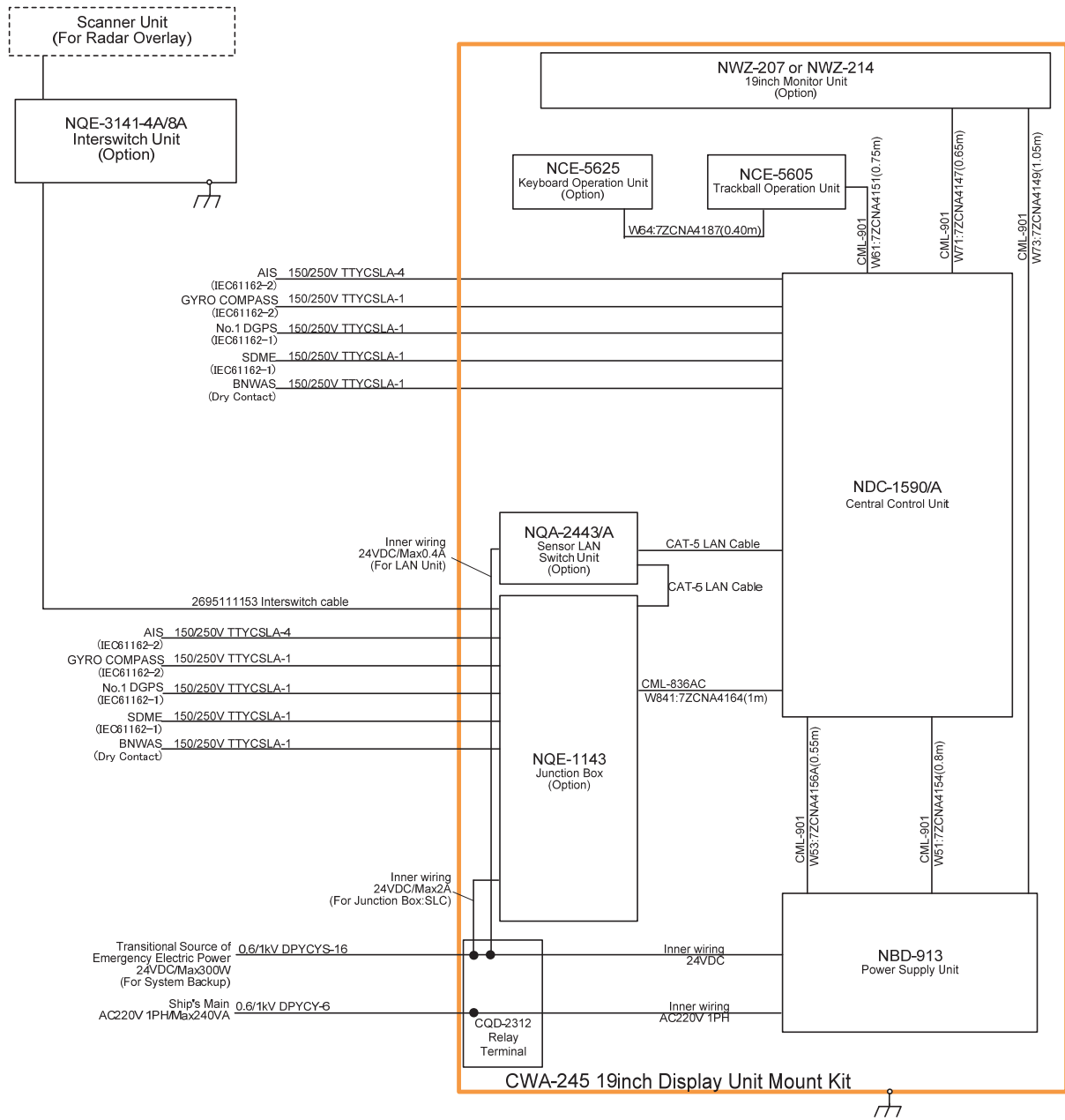

NOTE: ELIMINATING THE INTERFERENCE ON FREQUENCIES USED FOR MARINE COMMUNICATIONS AND NAVIGATION DUE TO OPERATION OF THE RADAR, ALL CABLES OF THE RADAR ARE TO BE RUN AWAY FROM THE CABLES OF RADIO EQUIPMENT. (ex. RADIOTELEPHONE, COMMUNICATIONS RECEIVER and DIRECTION FINDER, etc.) ESPECIALLY INTER-WIRING CABLES BETWEEN SCANNER UNIT AND DISPLAY UNIT OF THE RADAR SHOULD NOT BE RUN PARALLEL WITH THE CABLES OF RADIO EQUIPMENT.

General System Diagram of JAN-7201

Section 2 Name and Function of Each Unit

2.1 Name and Main Function of the Operation Unit

2.1.1 Trackball operation unit

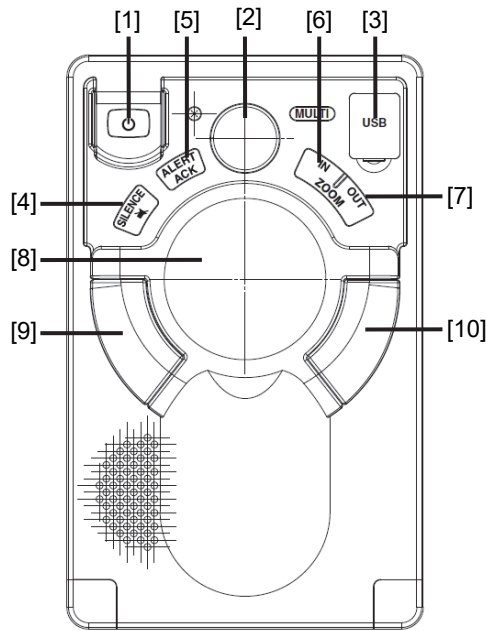

WARNING

When turning off the power supply, do not hold down the power button of the operation unit.
Otherwise, a trouble may occur due to termination failure.

No.	Name	Function outline
1	Power supply button	Use this button to turn on and off this equipment.
2	[MULTI] dial	<ul style="list-style-type: none"> • Turn this dial to operate the function that is assigned to the [MULTI] dial such as the Display Brightness function. • If the [MULTI] dial is held down, the Display Brightness function is assigned to the [MULTI] dial forcibly.
3	USB terminal	Connects a USB flash memory.
4	[SILENCE] key	Stops the alert buzzer.
5	[ALERT ACK] key	Acknowledging the alert.
6	[ZOOM IN] key	<ul style="list-style-type: none"> • "Scale" Setting will increment one step larger. • When this key is held pressed, setting will step continuously until released.

No.	Name	Function outline
7	[ZOOM OUT] key	<ul style="list-style-type: none"> • "Scale" Setting will increment one step smaller. • When this key is held pressed, setting will step continuously until released.
8	Trackball	Moves the cursor on the screen. Use the trackball to specify a position or to perform various settings.
9	Left button	<ul style="list-style-type: none"> • Use this button to select a function or determine the operation that is set. • The clicking of the left button once is referred to as "click" in this manual. • The clicking of the left button twice consecutively is referred to as "double click" in this manual.
10	Right button	<ul style="list-style-type: none"> • Use this button to select a function or perform setting operation. • The clicking of the right button is referred to as "right click" in this manual.

2.1.2 Keyboard operation unit (Option)

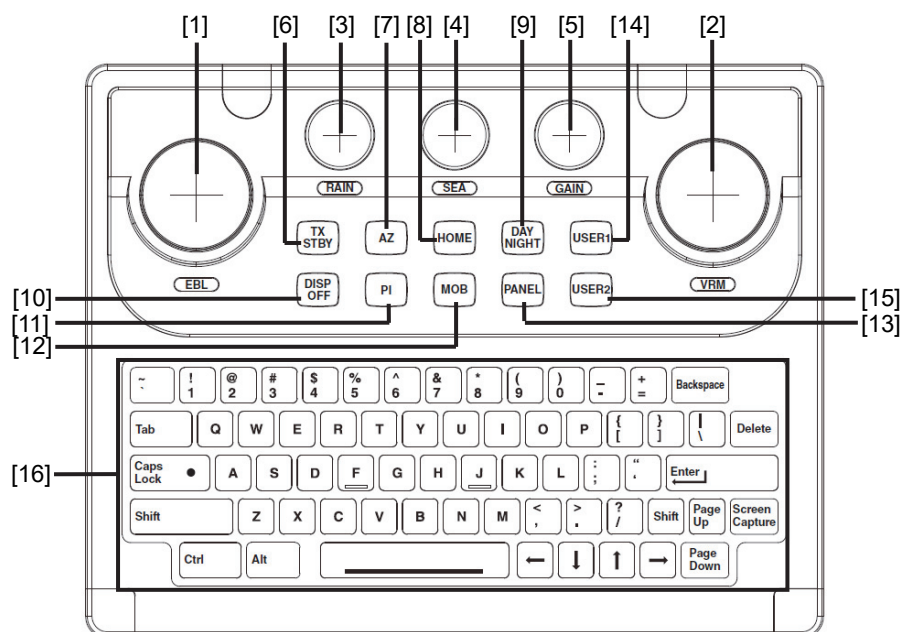

No.	Name	Function outline
1	[EBL] dial	When this dial is turned, control moves in the EBL (PI) direction with control right. This dial also moves the cursor horizontally (in cursor move mode).
2	[VRM] dial	When this dial is turned, control moves in the VRM (PI) direction with control right. This dial also moves the cursor vertically (in cursor move mode).
3	[RAIN] dial	<ul style="list-style-type: none"> • When this dial is turned, the level of rain/snow clutters on the radar image is adjusted. • When this dial is pressed, the function mode is switched to manual/automatic.
4	[SEA] dial	<ul style="list-style-type: none"> • When this dial is turned, the level of sea clutters on the radar image is adjusted. • When this dial is pressed, the function mode is switched to manual/automatic.
5	[GAIN] dial	When this dial is turned, the gain of the radar image is adjusted.
6	[TX STBY] key	When this dial is pressed, the radar image on the chart is switched to "On" or "Off".
7	[AZ] key	<ul style="list-style-type: none"> • Switches AZ between On and Off. • When this button is held down, the [AZ] key allocation dialog is displayed.
8	[HOME] key	Returns own ship to the home position within the display screen. <ul style="list-style-type: none"> - TM: Moves the own ship to the TM RESET position. - RM: Moves the own ship to the on-center position (when it is at off-center only).
9	[DAY NIGHT] key	Switches the display color on the screen over 5 levels according to the brightness on the bridge.

No.	Name	Function outline
10	[DISP OFF] key	The assigned function is executed while the key is pressed. The function that can be assigned is Data Off.
11	[PI] key	<ul style="list-style-type: none"> Switches the PI operation/display to On/Off. For PI operation, refer to "4.6 Using Parallel Index Lines (PI)". When this key is held down, the cursor mode is changed to the floating PI mode.
12	[MOB] key	<ul style="list-style-type: none"> Displays the MOB symbol and the setting dialog box in the own ship's position latitude/longitude. When this key is held down, the MOB symbol and the setting dialog box are cleared.
13	[PANEL] key	Whenever this key is pressed, the brightness of the panel on the operation unit is switched.
14	[USER1] key	<ul style="list-style-type: none"> Executes the function that is assigned to the key. When this key is held down, the setting dialog box of the function that is assigned to the [USER1] key appears.
15	[USER2] key	<ul style="list-style-type: none"> Executes the function that is assigned to the key. When this key is held down, the setting dialog box of the function that is assigned to the [USER2] key appears.
16	Keyboard	The keyboard is used for input of numeric values and characters at operation of this equipment.

2.1.3 Display unit

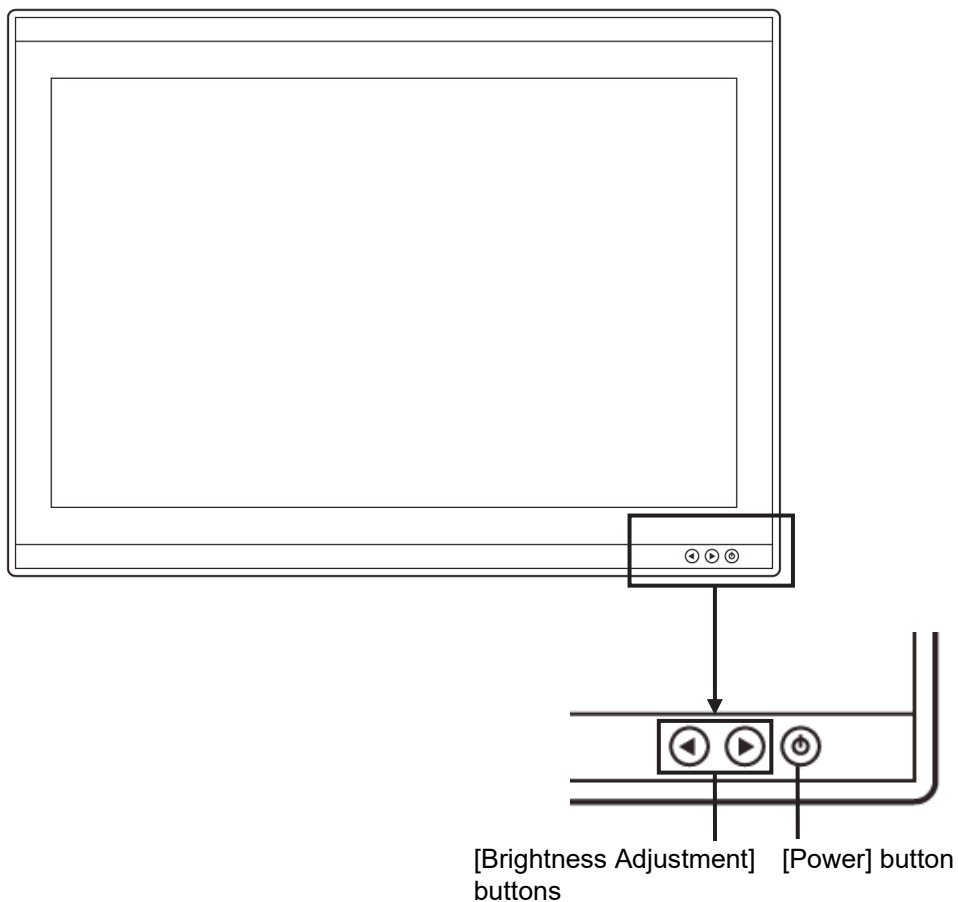

[Power] button

When the Power button is pressed while the power of the display unit is turned off, the power is turned on.

To turn off the power of the display unit, press the Power button for 5 seconds or longer.

[Brightness Adjustment] buttons

These buttons are used to adjust the brightness of the screen.

The screen increases brightness by pressing the  button.

The screen decreases brightness by pressing the  button.

Memo

Adjust the brightness of the screen to the extent it is not dazzling, taking into account the brightness of the surroundings and to the brightness which you can be easily observed the ECDIS screens.

Be careful in the nighttime brightness adjustment because nighttime brightness adjustment may hinder the visibility of information.

2.2 Names and Main Functions of the Top Screen

This section describes the names and main functions of the top screen.

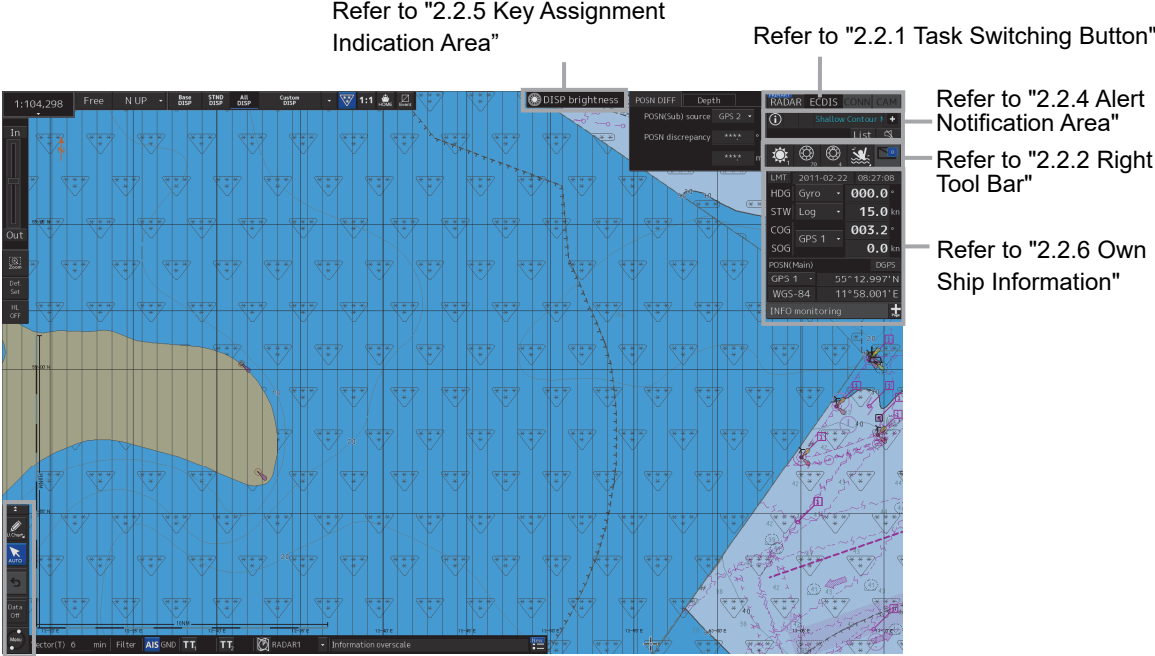

Refer to "2.2.3 Left Tool Bar"

The content of the "Chart Information Area" differs when the chart is ENC/C-MAP and is RNC. The "Sub-Information Area" is common related to the type of chart.

Refer to "2.2.7 Chart Information Area (ENC/C-MAP)".

Refer to "2.2.9 Sub Information Area".

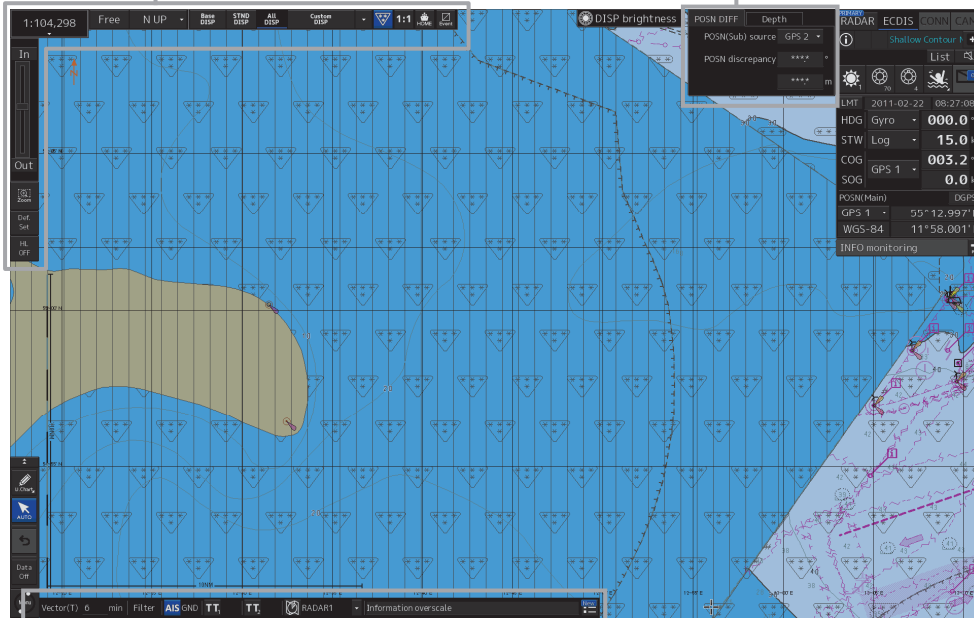

Refer to "2.2.10 Bottom Bar (Sub Information Area)".

Display Example on the ENC/C-MAP Screen

Refer to "2.2.8 Chart Information Area (RNC)".

Refer to "2.2.9 Sub Information Area".

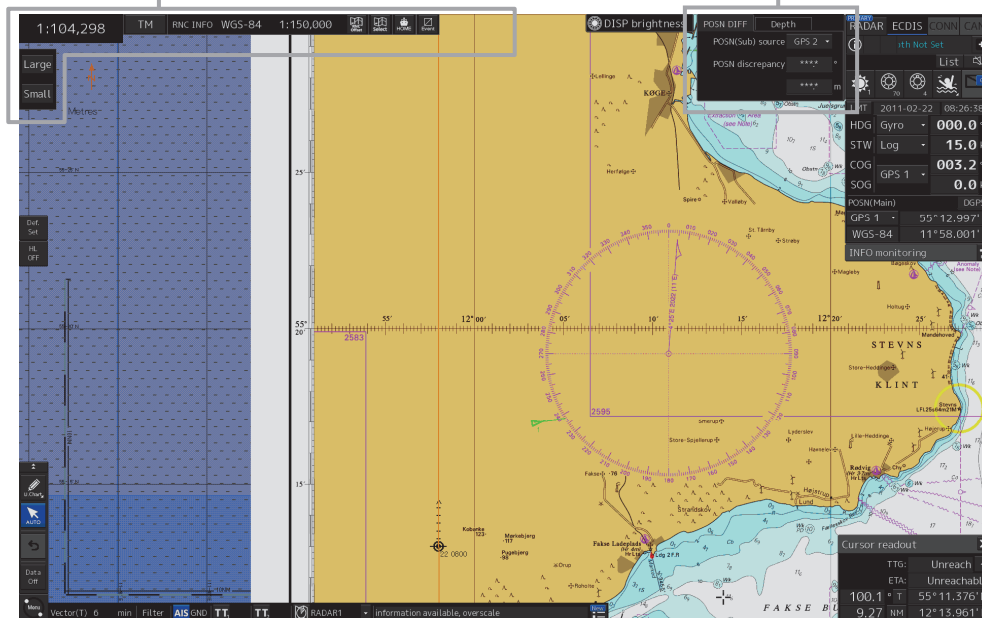

Display Example on the RNC Screen

2.2.1 Task Switching Button



To switch to a required task, click on the task switching button.

Click on the task to be executed from [RADAR]/[ECDIS]/[CONN](Conning Display)/[CAM].

Memo

The [Primary] badge is displayed on the task that is set to the Primary function (basic task).

Example: ECDIS is the Primary function



2.2.2 Right Toolbar

The functions of the buttons of the right toolbar are as follows.

Day/Night button

The display color on the screen can be switched to 5 levels according to the brightness on the bridge.

For the details, refer to "3.8 Switching the Day/Night Mode".

Message notification button

When this button is clicked on, the dialog box relating to the latest message among the information received in AIS MSG Tray and NAVTEX is displayed.

For the message dialog box of each of the information received, refer to "2.3.2 Information reference windows".

The total number of unread messages is displayed on the badge.

Display Brightness button

The brightness of the screen and operation unit can be switched within the range from 0 to 100.

For the details, refer to "3.9.1 Adjusting the Brightness of the Screen".

MOB (Man Over Board) button

When a person falls overboard, use this button to mark the own ship's position when the button is clicked on, so as not to lose the sight of the position.

For the details, refer to "3.11 MOB (Man Over Board)".



Panel Brightness button

Switch the brightness of the operation unit to any of the 5 levels, 0 to 4.

For the details, refer to "3.9.2 Adjusting the Brightness of the Operation Unit".

2.2.3 Left Toolbar

The functions of the buttons of the Left Toolbar are as follows.

Some buttons on the Left Toolbar are normally displayed and others are not.

Click on the Disclosure button to switch the display.

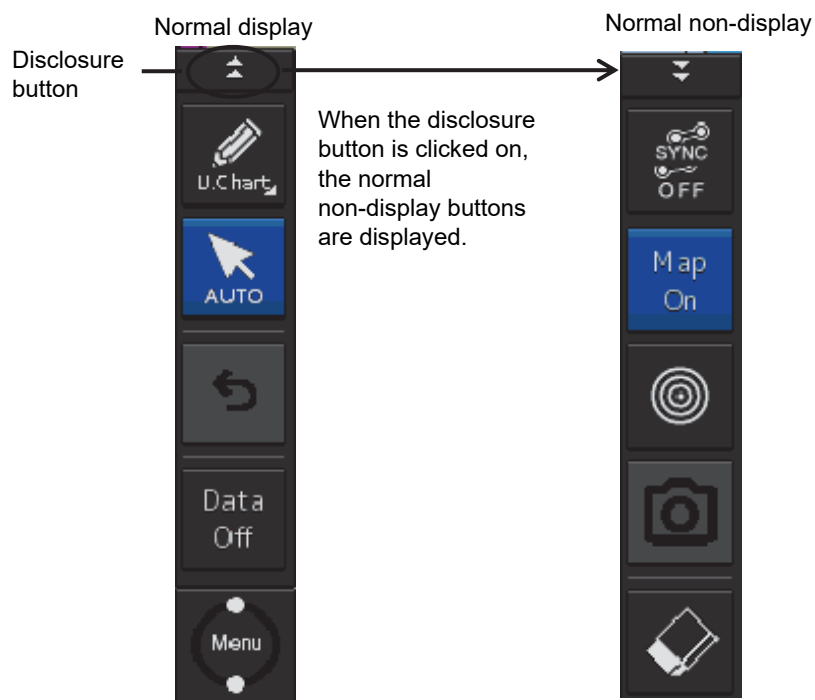

Refer to the next page for the name and function of each button.

2.2.3.1 Buttons that are normally displayed

PEN (Write tool) button

Clicking on this button during user chart creation, manual chart update or route planning brings up the corresponding operation mode.
The mode name will be indicated on the button.



Example: [U.Chart] (User Chart) mode

[U. Chart] (User Chart) mode

Clicking on the button when it indicates [U. Chart] displays the drawing toolbar for user charts.

*When this mode is used, the azimuth mode will be fixed to N UP (North UP).

[Update] (Manual Update) mode

Clicking on the button when it indicates [Update] displays the [Select Chart] dialog box if a chart to be manually updated has not been selected. If a chart to be manually updated is selected, the drawing toolbar for manual update will be displayed.

*When this mode is used, the azimuth mode will be fixed to N UP (North UP).

[Route] (Route Planning) mode

Clicking on the button when it indicates [Route] brings up a new route planning mode if no route planning tab is open. If one or more route planning tabs are open, the system switches from the end of the routes currently being created to the WPT addition mode.



[AUTO] (Cursor mode selection) button

When this button is clicked on, the cursor mode is switched to the AUTO mode.

For the details of the cursor mode, refer to "3.14 Cursor AUTO Mode".

[Undo] button

Clicking on this button cancels the previous operation performed.

- In user chart creation mode
- In manual update creation mode

[Data OFF] button

When this button is clicked on, only the main information is displayed from the screen display and other information is hidden.

The following information items are displayed:

- Own ship's symbol
- Route
- Temporary Route
- Chart
- Base category object
- Non-ENC object
- Cursor

*The chart is displayed when the display category is [Base].

[Menu] button

When this button is clicked, the top menu is displayed.

For the details of the menu, refer to "3.4 Basic Menu Operations".

Right-clicking on the menu button displays the context menu.

- System Information: Software version display
- Check Status: Version display of installed charts

Memo

This equipment is operating normally when the [Menu] button is moving on animation mode. When this equipment is set to a freeze state, the Menu button stops and does not move. In this case, turn off the power once and turn it on again.

2.2.3.2 Buttons that are normally hidden

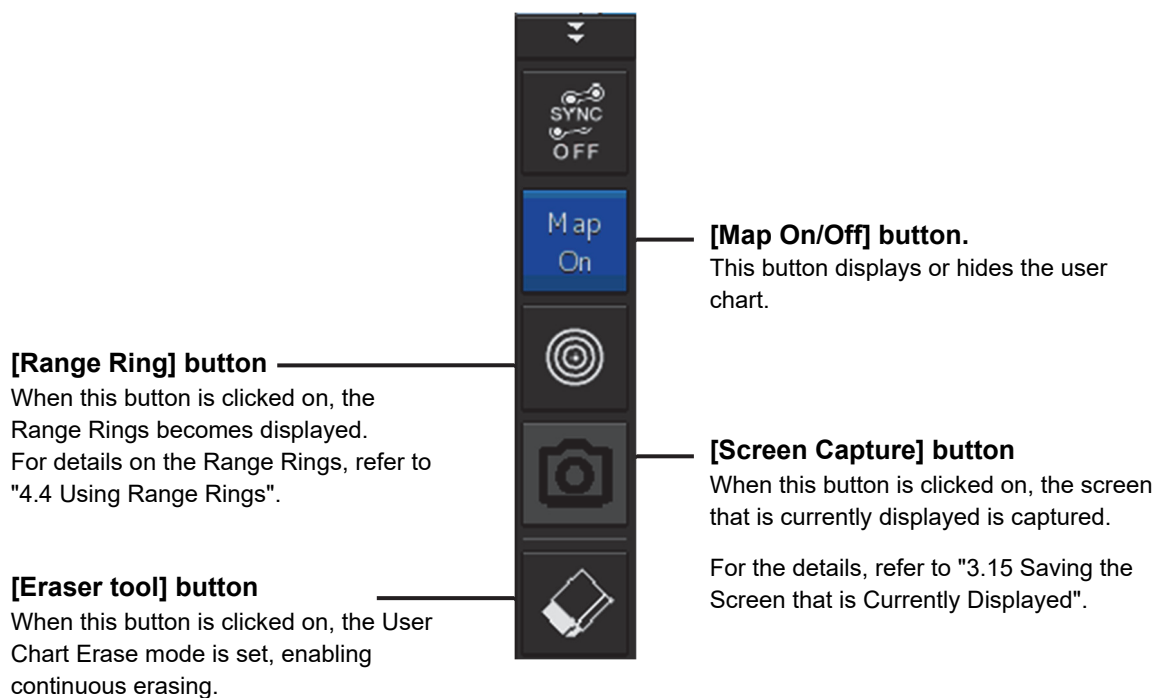

2.2.4 Alert notification area

When an alert occurs, the alert status, the contents of the alert and the occurrence count are displayed in the alert notification area.

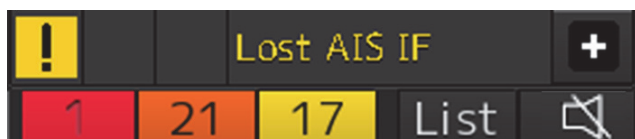

For the details, refer to "3.7 Confirming and Acknowledging an Alert".

2.2.5 Key assignment indication area

When the [MULTI] dial is turned, the assigned functions are operated.



For the function assignment, refer to "3.16 [Multi] dial".

2.2.6 Own Ship Information



Do not use the offset function during navigation.
 If the equipment is used with the offset value entered as the own ship position (deviated from the actual position), accidents may result.
 When the offset values are entered, the [Offset] badge is displayed at the position display on the Own Ship Information. Check the indication, and cancel the offset function if necessary.

POSN(Main)	Offset	DGPS
GPS	34° 43.373' N	
WGS-84	136° 43.619' E	

This window displays the own ship's information.



- When using 1-axis log, heading speed component can be detected, but transverse speed component cannot be detected. Then leeway effect (component drifted by wind) cannot be detected.
- When using 2-axes log, its accuracy in shallow waters may be deteriorated, and its speed in deep sea areas may be unable to be detected.
- When using a GPS, COG accuracy is less than $\pm 3^\circ$ at speed: from 1kn to 17kn, and is less than $\pm 1^\circ$ at speed: more than 17kn.

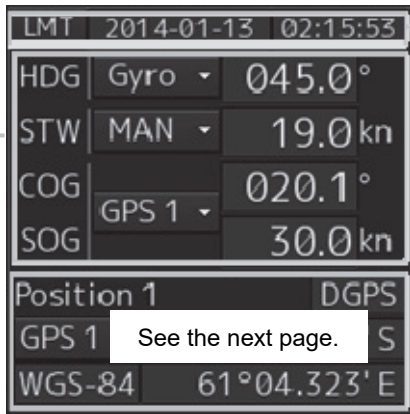

UTC/Local date and time

This button displays the current date and time.

- When the button is clicked on, the time can be switched to the UTC time display or Local time display.
- Set the time format by selecting [Maintenance] - [Date/Time/Time Zone]-[Display Style] on the menu.

For the details, refer to "19.1.2 Setting Date/Time/Time Zone".

Sensor information

Various sensor information items are displayed.

[Sensor types]

Sensor name	Contents
HDG	Displays the value indicated by the ship's heading sensor.
STW	Displays the value indicated by the speed through water sensor.
COG/SOG	Displays the value indicated by the speed over the ground sensor.

[Sensor value background colors]

Each background color represents the following meaning.

Normal color: Normal sensor value

Yellow: The reliability of the sensor value is deteriorating.

Yellowish orange: The sensor value is abnormal.

Note

When position offset is applied, the background color of "GPS" and "DR" part changes to yellow.

[Switching the sensor source]

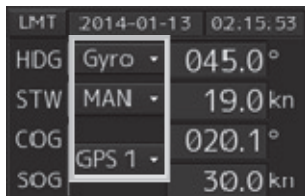

Select the sensor source in the [Source] combo box. The following sensor sources can be selected.

When [Menu] is selected, the [Sensor Selection/Status] dialog is displayed.

Sensor name	Sensor source
HDG	MAN (Manual), Gyro, Gyro 1 ^{*1*4} , Gyro 2 ^{*1*4} , MAG (MAG Compass) ^{*4} , G/C (GPS Compass)
STW	MAN (Manual), Log ^{*5} , Log 1 ^{*2*5} , Log 2 ^{*2*5}
COG	Log ^{*5} , Log1 ^{*2*5} , Log 2 ^{*2*5} , GPSx ^{*3}
SOG	

*1: Only when there are two Gyros.

*2: Only when there are two Logs.

*3: When two or more GPS units are present, "x" indicates the unit number.

*4: When the Gyro Compass system that is used has the automatic switching function, the display of the sensor source changes automatically according to the switching condition.

*5: When 1AX is installed in Log, Log cannot be selected from the sensor source.

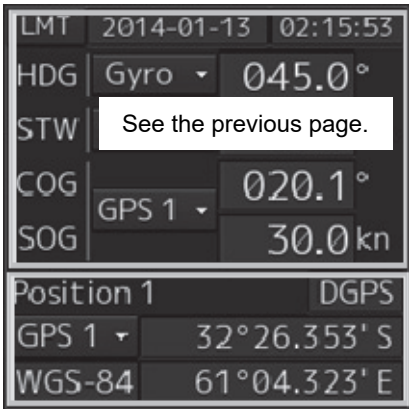

Position

Displays Position information.

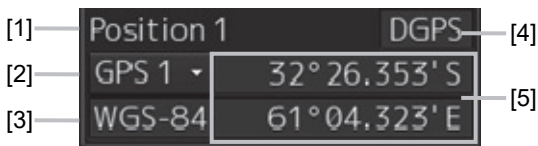

[1] The data name of the Position is displayed.

[2] The sensor source of the Position is displayed.

Select a sensor source in the [Source] combo box. Any of the following sensor sources can be selected. When [Menu] is selected, the [Sensor Selection/Status] dialog is displayed.

Data name	Sensor source
POSN(Main)	GPSx*, DR

*: When two or more GPS units are present, "x" indicates the unit number.

[3] A geodetic positioning system is displayed. It is fixed to "WGS-84".

[4] Positioning precision display

When the positioning precision is differential positioning, "DGPS" is displayed. No information is displayed in the case of GPS single positioning.

[5] Position (CCRP)

The CCRP position indicated by the primary positioning sensor is displayed.

Own ship's position offset display

When offset is set for the own ship's position, the icon that indicates the offset status is displayed for the Position

2.2.7 Chart Information Area (ENC/C-MAP)

Scale/Range combo box

This button displays the current scale or range.



Scale display

Range display

Select a scale or a range from the combo box.

For the details, refer to "6.4.3 Switching between scale and range (S-57/C-MAP only)".

Motion mode combo box

This button sets the motion mode.

For the details, refer to "6.6.1

Setting motion mode".

Bearing mode combo box

This button sets the bearing mode.

For the details, refer to "6.6.2 Setting Bearing

mode (S-57/C-MAP only)".

See the next page.

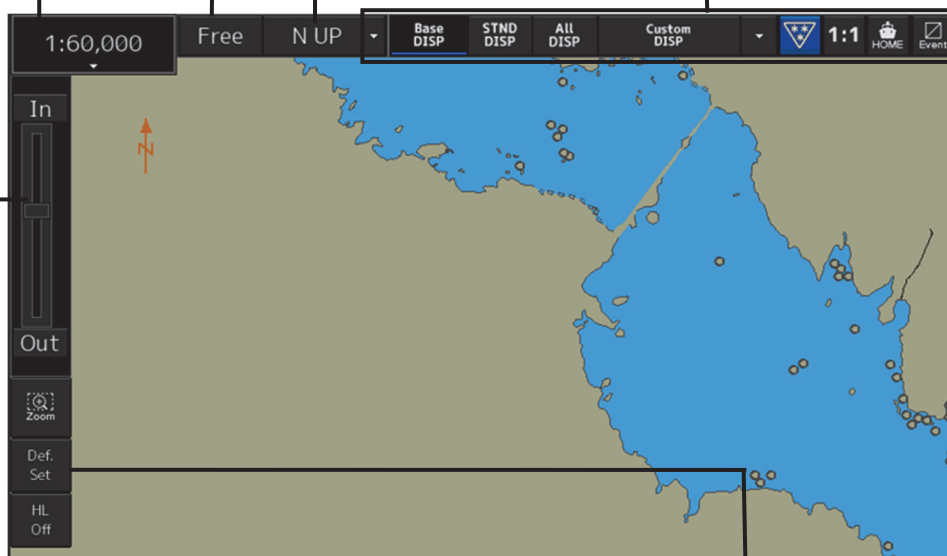

Zoom slider

The zoom slider expands/reduces the display in scale/range.



For the details, refer to 6.4.2.2 "Enlarging/reducing with the zoom slider (S-57/C-MAP only)".

For the details, refer to "6.4.2 Enlarging/reducing a chart with the Zoom function".

For the details of the Heading Line, refer to "14.2.1 Setting up the Display of Own Ship Symbol".

[Def. Set] (Settings at shipment) button
When this button is clicked on, the screen display return from the personal setting information to the settings at shipment. The function is the same as that of the [Default display configurations] button in [Preference] on the [Settings] dialog box. For the details, refer to "16.18 Setting Preferences Information".

Display category

Set the display category of the chart.

For the details, refer to "6.5 Changing the Object Category (S-57/C-MAP Only)".

CATZOC display button (S-57 only)

When this button is clicked on, the accuracy information of the chart will be displayed.

Original scale display button (S-57 only)

When this button is clicked on, the screen scale is changed according to the original scale of the chart that is displayed at the center of the screen.

[Home] button

When this button is clicked on, the chart screen moves to the position at which the own ship's position is to be displayed.

For the details, refer to "6.3.1 Moving the chart with the [HOME] button".

[Event] button

When this button is clicked on, an event mark is assigned at the own ship's position.

For the details, refer to "6.12 Marking the Position of Own Ship with an Event Mark".

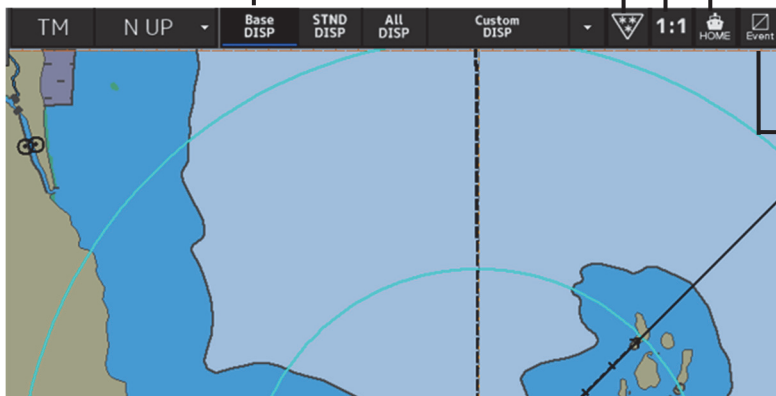

2.2.8 Chart Information Area (RNC)

Scale/Range button

This button displays the current scale.

The scale cannot be changed.

Motion mode button

This button sets the motion mode.

For the details, refer to "6.6.1 Setting motion mode".

RNC information display

This area shows the geodetic datum and the original scale of the chart that is displayed.

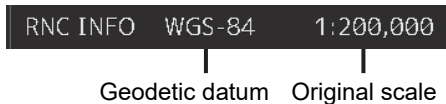

See the next page.

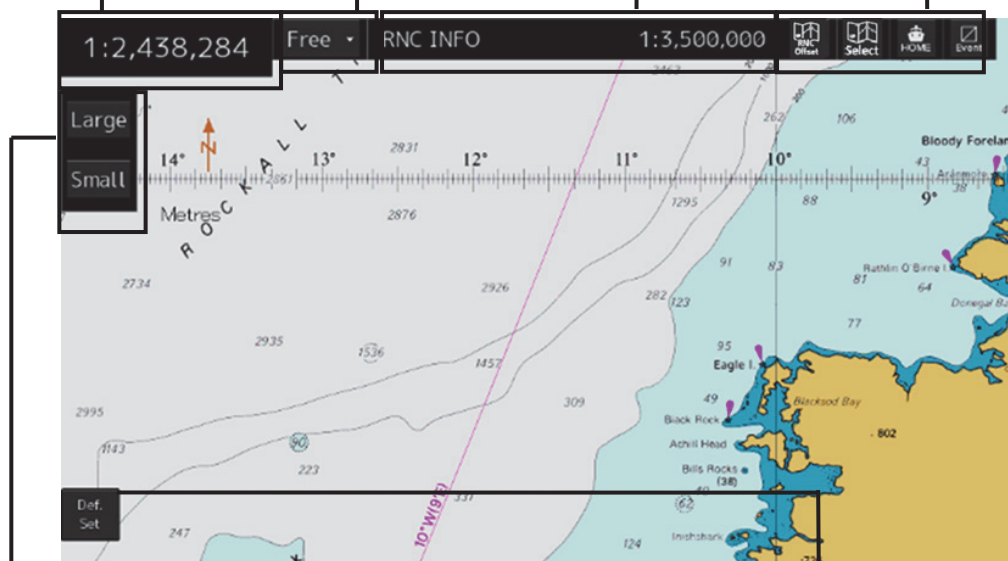

[Large]/[Small] button

This button switches the chart scale between Large and Small.

For the details, refer to "6.4.2.3 Enlarging/reducing with the [Large]/[Small] buttons (RNC only)".

[Def. Set] (Settings at shipment) button

When this button is clicked on, the screen display return from the personal setting information to the settings at shipment.

The function is the same as that of the [Default display configurations] button in [Preference] on the [Settings] dialog box. For the details, refer to "16.18 Setting Preferences Information".

Chart offset amount display
 When this button is clicked on, the chart offset amount is displayed on the dialog box.

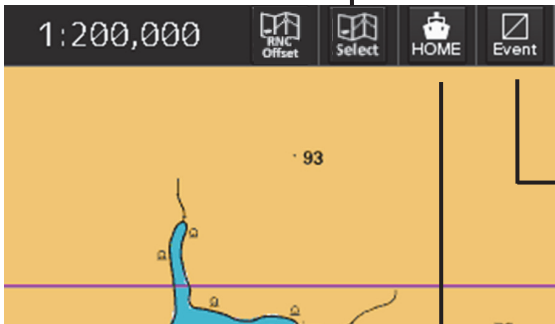

Chart selection button
 Select a chart from the [Select chart] dialog box that is displayed by clicking on this button.
 For the details, refer to "6.9.1 Selecting charts from all".

[Event] button
 When this button is clicked on, an event mark is assigned at the own ship's position.
 For the details, refer to "6.12 Marking the Position of Own Ship with an Event Mark".

[Home] button
 When this button is clicked on, the chart screen is moved to the position at which the own ship's position is displayed.
 For the details, refer to "6.3.1 Moving the chart with the [HOME] button".



2.2.9 Sub Information Area

Memo

- The display position of Sub Information Area varies according to the display size.

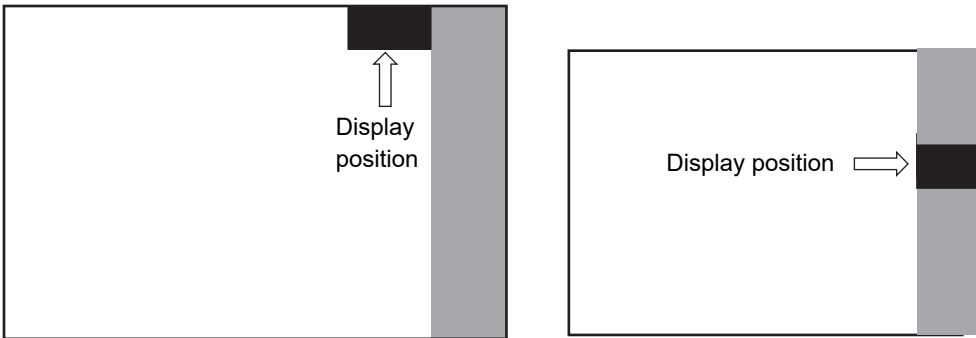

26inch screen (WUXGA)

19inch screen (SXGA)

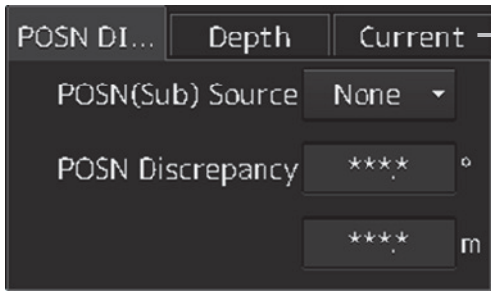

Switching tab

When this tab is clicked on, the contents of the dialog are switched.

- [1] [POSN DIFF] (Position/distance difference) dialog
- [2] [Depth] (Depth) dialog
- [3] [Current] (Current) dialog

Memo

The tab that is displayed varies depending on the setting.

To set up, select [View] - [Options] - [Control] on the menu.

For the details, refer to "14.2.16 Setting up display of Own Ship Track Control, display format of Own Ship/Cursor Position and display of Sub-Information Dialog".

[1] [POSN DIFF] dialog

Displays the difference of bearing and distance between POSN(Main) and POSN(Sub).

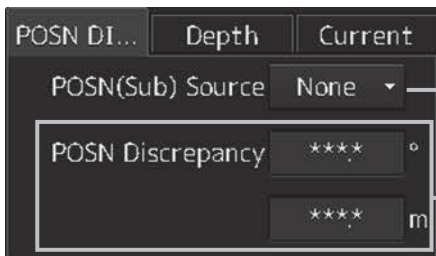
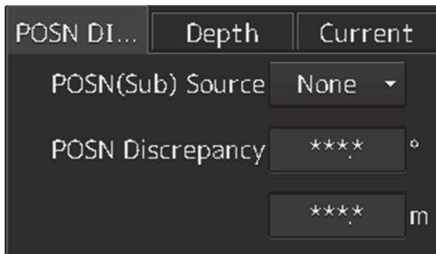

[POSN(Sub) Source] combo box

Displays the source of the sub position.

When there are multiple sub position sources, select a source from the combo box.

[POSN Discrepancy]

Displays the difference of bearing and distance between POSN(Main) and POSN(Sub).

[2] [Depth] dialog

Displays the water depth.

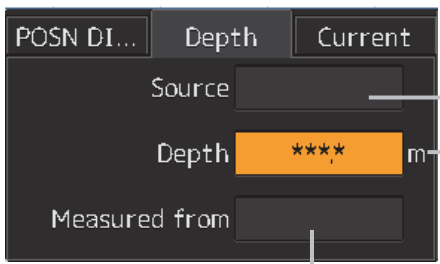

[Source]
Displays the depth sounder that is used.
FWD: Depth sounder installed at the front of the ship
MID: Depth sounder installed at the center of the ship
AFT: Depth sounder installed at the rear of the ship
None: Hides the [Depth] tab.
When a depth sounder is not installed, the [Depth] tab is not displayed.

[Depth]
Displays the water depth.

[Measured from]
Displays the water depth measurement reference position.
Transducer: Transducer
Surface: Water surface
Keel: Keel

[3] [Current] dialog

Displays the bearing and speed of the current.

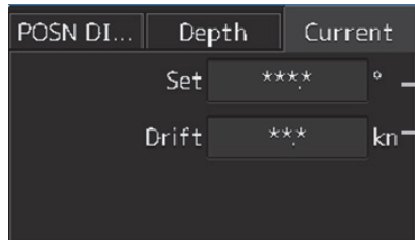





[Set]
Displays the bearing of the current.









[Drift]
Displays the speed of the current.



2.2.10 Bottom Bar (Sub Information Area)



The functions of the Bottom Bar are shown in the table below.

function	Operation / condition	Input range
Vector (T) length input box	Enter and set the vector length.	1~120min
AIS / TT Filter display	It indicates ON / OFF of AIS / TT filter function. 【conditions】 When AIS unused setting and TT unused setting are set, it will be hidden. When the display of Virtual AtoN is set to Off in the Menu-View-Target display setting, the "V AtoN Off" badge is displayed.	—
AIS function button	Switch ON / OFF of the AIS function. Function ON:  Function OFF:  【conditions】 When AIS is not used, the button and mode name are hidden.  ↓ When not in use  Display character: When AIS function is ON, the following will always be displayed. GND	—

function	Operation / condition	Input range
<p>TT1,2 function button</p>	<p>Turn on / off the TT1 or 2 function.</p> <p>Function ON:</p>  <p>Function OFF:</p>  <p>Display characters: One of the following is displayed according to the input contents.</p> <p>REL,GND,SE,***</p> <p>【conditions】</p> <p>When TT1 or 2 is not used, the button and mode name are hidden.</p>  <p>↓ When not in use</p> 	<p>—</p>
<p>Radar Overlay display button</p>	<p>Radar Overlay Toggles display on / off.</p> <p>Display ON:</p>  <p>Display ON:</p>  <p>【conditions】</p> <p>If there is no RADAR IF, hide the item. If there is a RADAR IF, it follows the following conditions.</p> <p>If ISW is installed, items are displayed.</p> <p>In case of no ISW, items are displayed / hidden by RADAR equipment setting.</p> <p>RADAR equipped: Displays the item.</p> <p>RADAR not equipped: Item is hidden.</p>  <p>↓ When not in use</p> 	<p>—</p>

function	Operation / condition	Input range
Radar switching Select the data input source of Radar Overlay	<p>▼ Click the button to display the selection item and update the display to the selected item.</p>  <p>【conditions】 If there is no RADAR IF, hide the item. If there is a RADAR IF, it follows the following conditions. If there is SW, items are displayed. At this time, the items that can be selected change depending on the equipment of the radar antenna. In case of no ISW, items are displayed / hidden by RADAR equipment setting. RADAR equipped: Displays the item. In this case, depending on the equipment setting of Radar 1 / Radar 2, the selectable items change. RADAR not equipped: Item is hidden.</p>	—
Permanent Information display area	Permanent currently occurring If there is information to be displayed, information messages (names) are continuously displayed at regular intervals.	—
Permanent information list display button	<p>Click the button to display the Permanent information list screen.</p> <p>【conditions】 If there is Permanent information, it becomes effective display. If there is no Permanent information, it becomes invalid display. If the permanent information list screen is hidden and there is unconfirmed information, a new badge is displayed.</p> 	—

2.2.11 ARCS PIN input dialog box

When an ARCS chart is imported, a dialog box for entering an ARCS PIN is displayed at the startup of the ECDIS mode.

For the details, refer to "6.2.3 Entering an ARCS PIN Number (ARCS Only)".

2.3 Common Information Window

The information that is displayed on the Common Information Window can be classified into information monitoring and information referencing.

An **information monitoring** window is used together includes TT/AIS value information, conning blocks, etc.

- Information monitoring windows are displayed at the bottom right corner of the screen are displayed at the bottom right corner of the screen at the initial display, the display positions can be moved as floating windows.

The **information reference** is the window that is temporarily referenced according to the user request and the information includes AIS messages, alert information, and own ship AIS information.

- The Information Reference can be switched to standard window display or extended window display. For the details of switching between the standard window and the extended window, refer to "2.3.2.1 Switching between a standard window and an extended window".

Information reference window

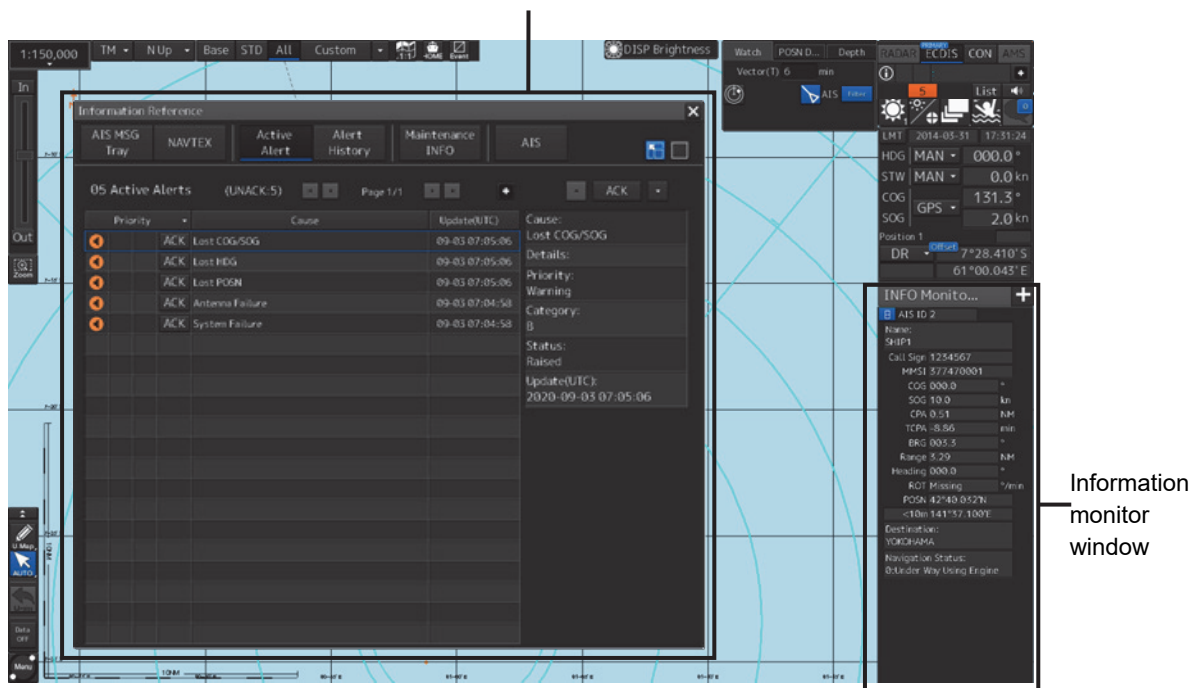

Memo

This section provides the overview of each common information window.

For the operations and settings of the common information windows, refer to "3.6 Operation of the Information Monitor Window".

2.3.1 Information monitor windows

Information monitoring related windows is as follows.

Item	Contents	Related section
Target INFO	TT/AIS movement information	2.3.1.1 Target INFO
TT1 List, TT2 List	Tracked target risk sequence list	2.3.1.2 TT List
AIS List	AIS target risk sequence list	2.3.1.3 AIS List
AIS Detail INFO	Detail information relating one AIS target	2.3.1.4 AIS Detail INFO
Current/Wind	Wind speed and current information	2.3.1.5 Wind/Current
Conning	Conning	2.3.1.6 Conning

2.3.1.1 Target INFO

Target INFO is the display monitor window that displays movement information of TT/AIS.

In Target INFO, TT information, AIS information, and AIS extended information are displayed.

TT information display

TT ID	4	1	
BRG	153.8	041.0	°
Range	8.84	8.48	NM
COG	012.3	028.7	°
SOG	8.7	10.1	kn
CPA	8.10	8.46	NM
TCPA	67.28	-Over	min
BCR		8.70	NM
BCT		+Over	min

The following information items are displayed.

Displayed information	Explanation
TT ID	Displays the identification number (1 to 100) of a tracked target. When an acquisition target is displayed from RADAR, it is displayed as "T1-***" or "T2-***" (***) indicates the target number or ship name).
BRG	Displays the bearing to a tracked target.
Range	Displays the distance to a tracked target.
COG	Displays the course of a tracked target. Displayed as COG in the courser over the ground.
SOG	Displays the ship speed of a tracked target. Displayed as SOG in the speed over the ground.
CPA	Displays the distance of the closest point of approach to the tracked target.
TCPA	Displays the arrival time of the closest point of approach to the tracked target.
BCR	Displays the bow crossing range of a tracked target.
BCT	Displays the bow crossing time of a tracked target.

AIS information



Standard display

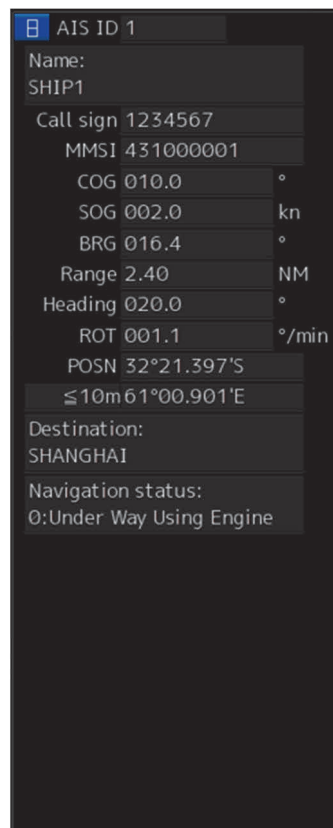

Extended display

- AIS information of the target is displayed.
- When the  (AIS standard/extension switching) button is clicked on, the display is switched between the standard display and the extended display.
- The following information items are displayed.

Displayed information	Explanation
AIS ID	Displays the identification number (1 to 1000) of an AIS target. *The maximum display number is 1000 as the option.
Name	Displays the ship name of an AIS target.
Call Sign	Displays a call sign.
MMSI	Displays a nine-digit identification number for a ship/ground station equipped with a DSC communication device.
COG	Displays the course of an AIS target. Displayed as COG in the courser over the ground.
SOG	Displays the ship speed of an AIS target. Displayed as SOG in the speed over the ground.
BRG*	Displays the bearing to an AIS target.
Range*	Displays the distance to an AIS target.
Heading*	Displays the heading of an AIS target.
ROT*	Displays the turning speed of an AIS target.
POSN and Position Accuracy*	Displays the position of an AIS target and position-fix accuracy. When the position-fix accuracy is low, [>10m] is displayed. When the position-fix accuracy is high, [<10m] is displayed.
Destination*	Displays the destination of an AIS target.
Navigation Status*	Displays the navigation conditions of an AIS target. For detailed explanation, refer to "Navigation Status" in the table provided in "2.3.1.4 AIS Detail INFO".

*: Extended display only

AIS SART information

AIS SART information is displayed by using an extended display.

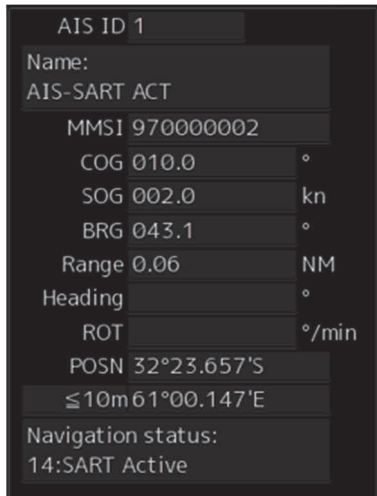

A screenshot of a digital display showing AIS SART information. The display is dark with light-colored text. The information is organized into several rows, some with units or symbols to the right. The data includes: AIS ID 1, Name: AIS-SART ACT, MMSI 970000002, COG 010.0 (with a degree symbol), SOG 002.0 (with 'kn'), BRG 043.1 (with a degree symbol), Range 0.06 (with 'NM'), Heading (with a degree symbol), ROT (with a degree and slash min symbol), POSN 32°23.657'S, and a second line of coordinates ≤10m 61°00.147'E. At the bottom, it shows 'Navigation status: 14:SART Active'.

AIS ID 1	
Name:	
AIS-SART ACT	
MMSI 970000002	
COG 010.0	°
SOG 002.0	kn
BRG 043.1	°
Range 0.06	NM
Heading	°
ROT	°/min
POSN 32°23.657'S	
≤10m 61°00.147'E	
Navigation status:	
14:SART Active	

Unlike the AIS information extended display, the following items are not displayed.



- Call Sign
- Destination
-  (AIS standard/extension switching) button

2.3.1.4 AIS Detail INFO

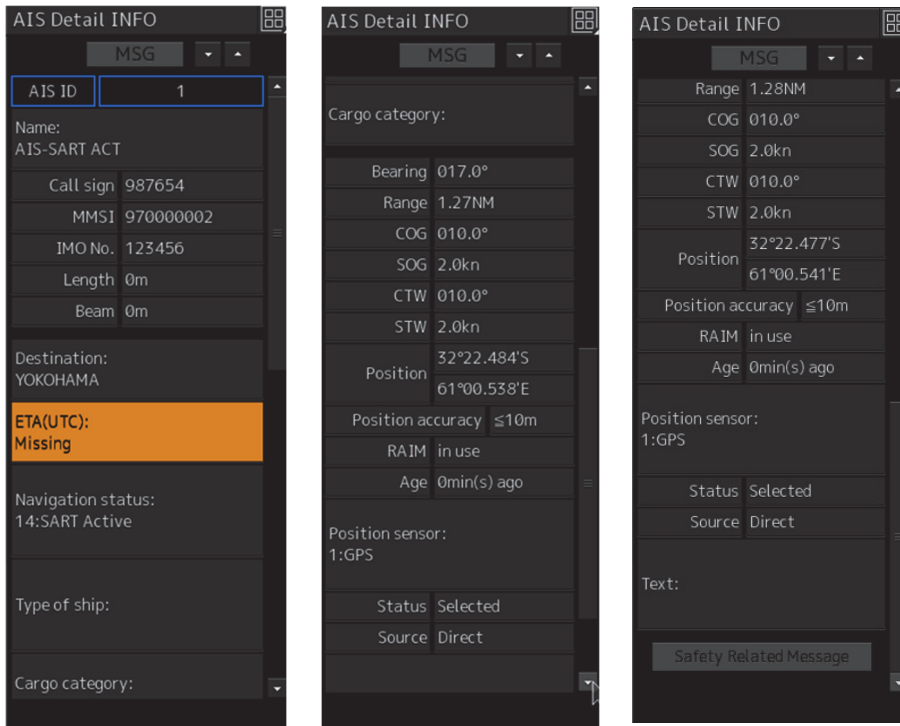
This window displays detail information on one AIS target.



AIS information of the target is displayed.

When either one of   is clicked on, AIS information before or after the information currently displayed is displayed.

When a safety message is received, **Message** is set to valid display. When **Message** is clicked on, the AIS message tray is displayed.

For the AIS message tray, refer to "2.3.2.2 AIS MSG Tray".

The following information items are displayed.

Displayed information	Explanation
AIS ID	Displays the identification number (1 to 1000) of an AIS target. *The maximum display number is 1000 as the option.
Name	Displays the ship name of an AIS target.
Call Sign	Displays a call sign.
MMSI	Displays a nine-digit identification number for a ship/ground station equipped with a DSC communication device.
IMO No.	Displays the 9-digit IMO number.
Length	Displays the length of an AIS target.
Beam	Displays the beam of an AIS target.
Destination	Displays the destination of an AIS target.
ETA or UTC	Displays the expected arrival time of an AIS target.

Displayed information	Explanation
Navigation Status	Displays the navigation conditions of an AIS target. 0: Under Way Using Engine 1: At Anchor 2: Not Under Command 3: Restricted Maneuverability 4: Constrained by Her Draught 5: Moored 6: Aground 7: Engaged in Fishing 8: Under Way Sailing 9: Reserved for HSC 10: Reserved for WIG 11: Reserved 12: Reserved 13: Reserved 14: SART Active 15: SART Test
Draft	Displays the draft of an AIS target.
Type of Ship	Displays the ship type of an AIS target. 30: Fishing Vessel 31: Towing Vessel 32: Towing Vessel L>200M B>25M (Towing and length of the tow exceeds 200m or breadth exceeds 25m) 33: Dredge or Underwater OPE (Engaged in dredging or underwater operation) 34: Vessel-Diving OPE (Engaged in diving operation) 35: Vessel-Military OPE (Engaged in military operation) 36: Sailing Vessel 37: Pleasure Craft 50: Pilot Vessel 51: Search and Rescue Vessels 52: Tugs 53: Port Tenders 54: With Anti-Pollution Equip(Vessels with anti-pollution facilities or equipment) 55: Law Enforcement Vessels 58: Medical Transports 59: Resolution No18:MOB-83(Ships according to Resolution No18(Mob-83)) 2X: WIG(Wing-in-Ground Effect Craft) 4X: High Speed Craft 6X: Passenger Ships 7X: Cargo Ships 8X: Tanker 9X: Other Type of Ship

Displayed information	Explanation
Cargo Category	When the setting of the type of a ship is 2X, 4X, 6X, 7X, 8X or 9X, the digit shown at the end of the code represents the cargo/condition. X1 Category X(DG/HP/MP) X2 Category Y(DG/HP/MP) X3 Category Z(DG/HP/MP) X4 Category OS(DG/HP/MP) X9 No Additional Information X0 All Ships of This Type
Bearing	Displays the bearing of an AIS target.
Range	Displays the distance to an AIS target.
COG	Displays the course of an AIS target. Displayed as "COG" in the course over the ground mode.
SOG	Displays the ship speed of an AIS target. Displayed as "SOG" in the speed over the ground mode.
CTW	Displayed as "CTW" in the course through the water mode.
STW	Displayed as "STW" in the speed through the water mode.
Heading	Displays the heading of an AIS target.
ROT	Displays the turning speed of an AIS target.
Position	Displays the position of an AIS target.
Position Accuracy	When the position-fix accuracy of an AIS target is low, [>10m] is displayed. When the position-fix accuracy of an AIS target is high, [<10m] is displayed.
RAIM	Displays the RAIM-flag of an AIS target. 0: RAIM not in use 1: RAIM in use
Age	Displays the age of an AIS target.
Position Sensor	Displays the type of the position sensor used by an AIS target. 0: Not Defined 1: GPS 2: GLONASS 3: Combined GPS/GLONASS 4: Loran-C 5: Chayka 6: Integrated Navigation System 7: Surveyed 8: Galileo 15: internal GNSS

Displayed information	Explanation
Status	Status of an AIS target <ul style="list-style-type: none"> • Sleeping • Active • Selected • Lost Danger
Source	AIS information source <ul style="list-style-type: none"> - Direct - Repeated - VTS
DTE Indicator	Displays the DTE Indicator of an AIS target. 0: available 1: not available
AIS Class	Displays the class type of AIS.

2.3.1.5 Wind/Current

The Wind/Current Block shows the wind speed and current information.

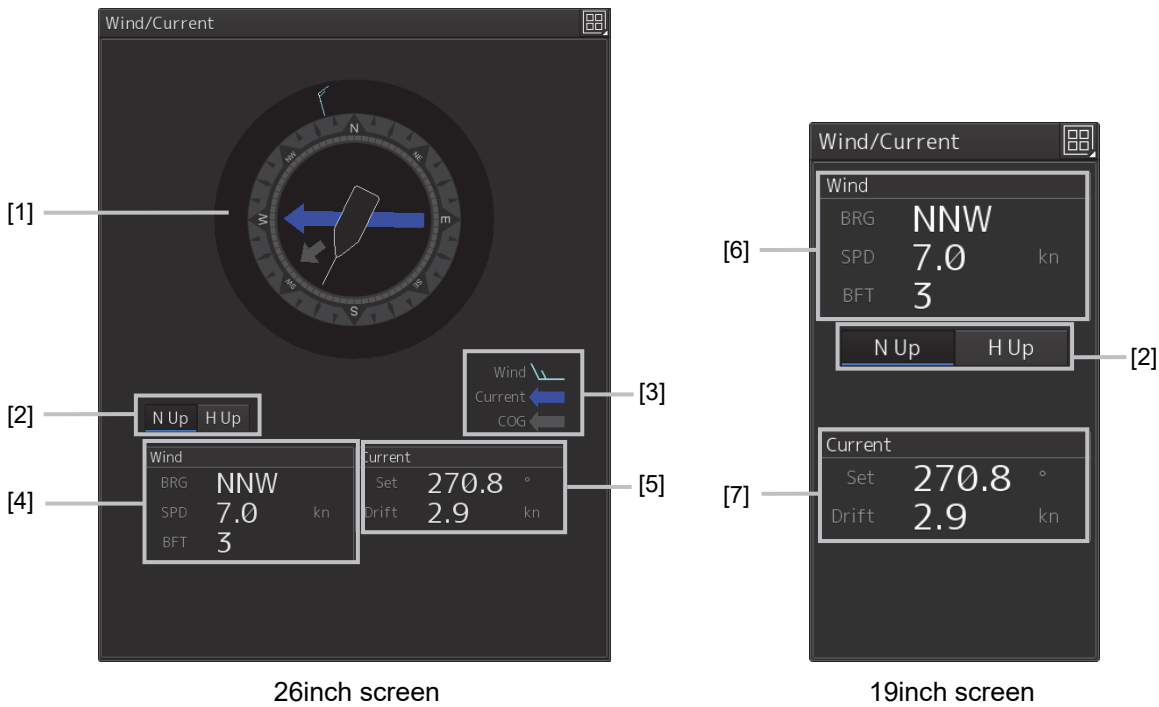

26inch screen

19inch screen

[1] Wind/Current meter

Displays the wind speed and current.

The display varies depending on the setting of the [N UP]/[H UP] (N-UP/H-UP switching) button.

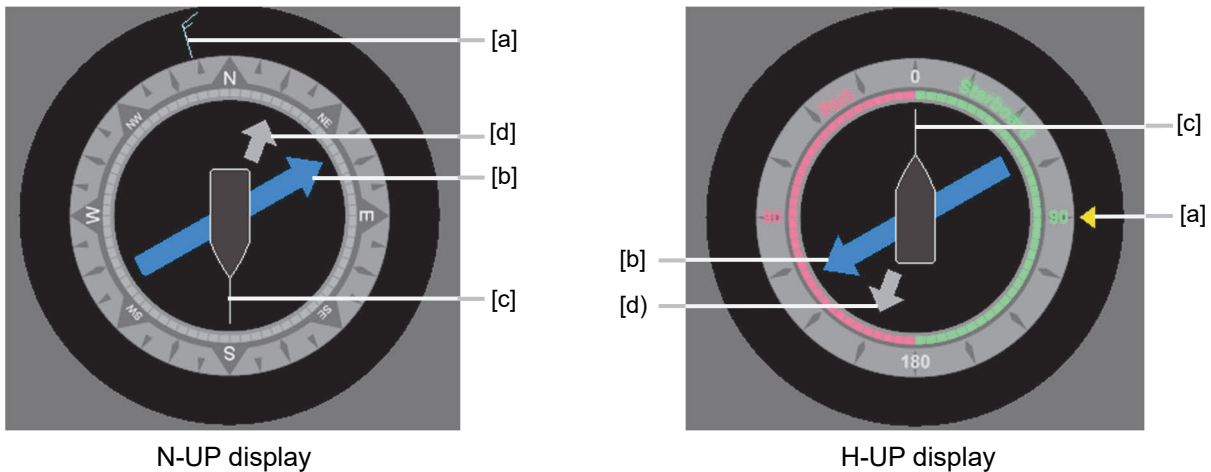

N-UP display

H-UP display

[a] Wind bearing/speed

Indicates the wind bearing/wind speed.

Arrow feathers are shown when N-UP is selected.

The arrowhead indicates a leeward direction. The number of feathers indicates the wind speed.

Memo

The number of feathers is based on the Beaufort scale.

A triangle arrow is shown when N-UP is selected.

The arrowhead indicates a leeward direction.

[b] Flow direction/speed

Indicates the flow direction.

The arrow indicates the direction of the current.

[c] Ship's heading

Indicates the ship's heading.

When N-UP is selected, the north of the direction ring of the meter is fixed on top, and the own ship symbol rotates to indicate the heading.

When H-UP is selected, the ship's heading is fixed on top to show the direction.

[d] Ground direction

Indicates the ground direction.

[2] [N UP]/[H UP] button

Used to change the display method for the ship's heading.

When the [U-UP] button is clicked, the north of the direction ring of the meter is fixed on top, and the own ship symbol rotates to indicate the heading.

When the [H-UP] button is clicked, the ship's heading is fixed on top to show the direction.

[3] Legends

Legends of the Wind/Current meter

[4] Wind bearing/speed information

Shows the wind bearing/speed information.

Display varies depending on the ship's heading display method.

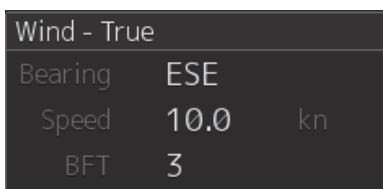

Ship's heading display is N-UP

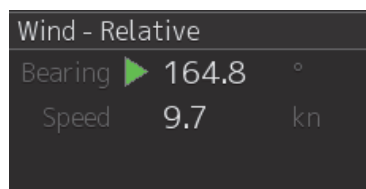

Ship's heading display is H-UP

For N-UP, [Bearing] (wind bearing), [Speed] (wind speed), and [BFT] (Beaufort scale) are shown as numerical values.

When H-UP is selected, [Bearing] (wind direction) and [Speed] (wind velocity) are displayed in numerical values. For a 26-inch screen, either of the following symbol is also displayed.

: Indicates the windward is on S (starboard) side.

: Indicates the windward is on P (port) side.

Memo

No symbol is displayed with the wind bearing 0° or 180°.

[Speed] (wind speed) is shown as a numerical value.

[5] Tidal current information

Shows the tidal current information.

Display varies depending on the ship's heading display method.

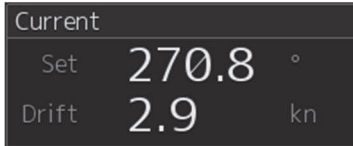

Ship's heading display is N-Up



Ship's heading display is H-Up

[Set] (tidal current direction) and [Drift] (current drift) are displayed in numeric values.

For 26-inch screen, either of the following symbols is also displayed.



: The downstream is on the S (starboard) side.



: The downstream is on the P (port) side.

Memo

When the tidal current bearing is 0° or 180°, no symbol is displayed.

[6] Wind bearing/speed information

Shows the wind bearing/speed information.

Display varies depending on the wind bearing true/relative display method.

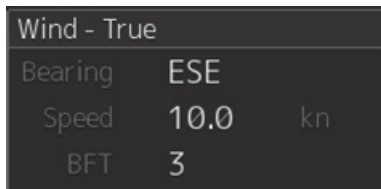

Ship's heading display is N-Up

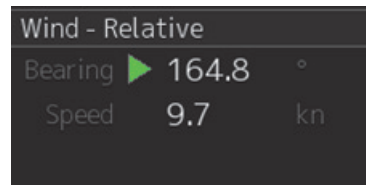

Ship's heading display is H-Up

For True wind bearing, [Bearing] (wind bearing), [Speed] (wind speed), and [BFT] (Beaufort scale) are shown as numerical values.

For display of a relative bearing, [Bearing] (wind direction) and [Speed] (wind velocity) are displayed in numerical values.

[7] Tidal current information

Shows the tidal current information.

Display varies depending on the ship's heading display method.

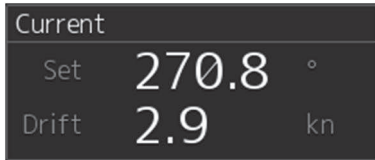

Ship's heading display is N-Up

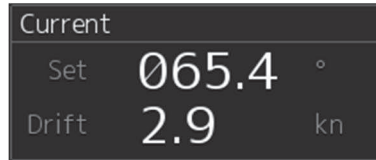

Ship's heading display is H-Up

[Set] (tidal current direction) and [Drift] (current drift) are displayed in numeric values.

2.3.1.6 Conning

The Conning shows simple conning information.

1 Click [Conning] on the [Page Selection] dialog box.

When [Conning] is not displayed, drag the scroll bar downward.

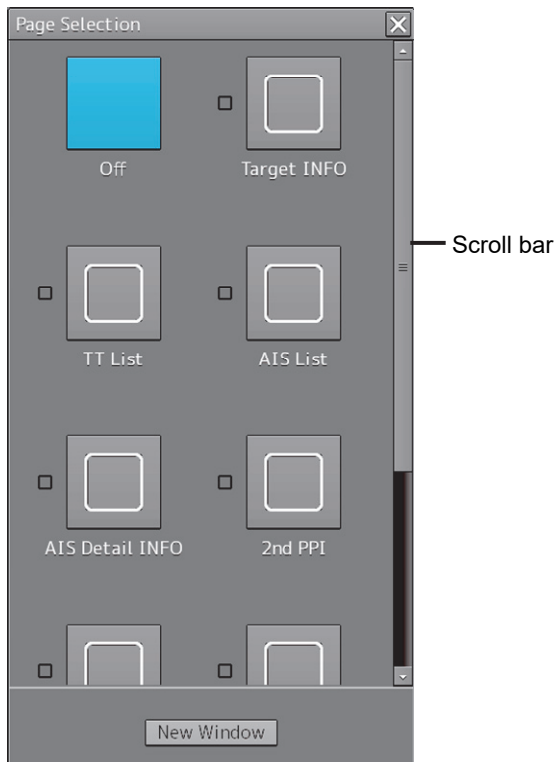

The [Conning] window is displayed.

There are four panes on the [Conning] window in the case of the 26-inch screen and one pane in the case of the 19-inch screen. A window switching button is provided in the pane.

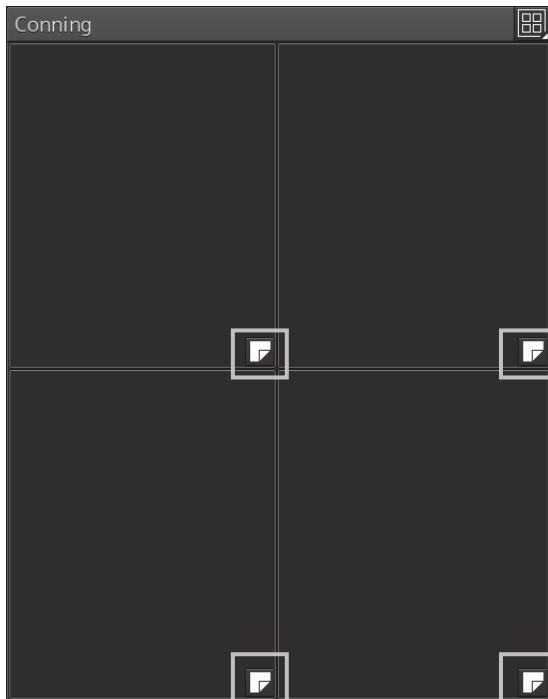

26-inch screen

2 Click a window switching button to show the [Contents Selection] window.

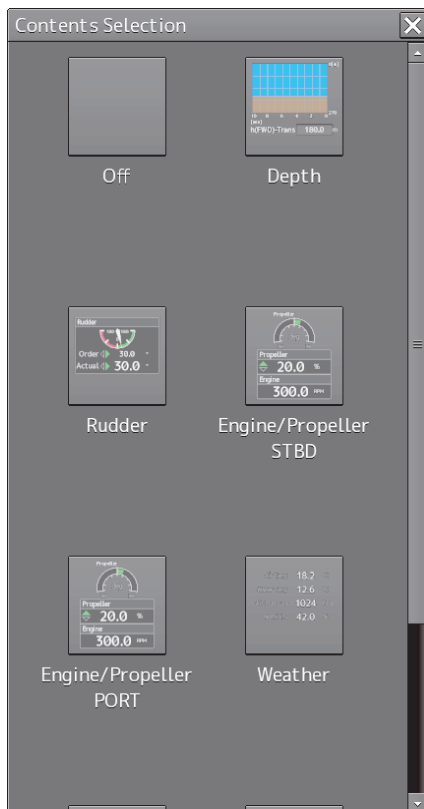

26-inch screen

Memo

When two Engines/Propellers are installed, two buttons are displayed on the 26-inch screen, one for port (PORT) and the other for starboard (STBD).

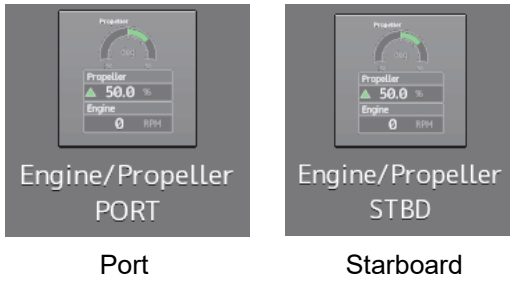

3 Click on the button of the information to be displayed on the pane.

- [Off]: No display
- [Depth]: Water depth information
- [Rudder]: Rudder angle information
- [EngineREV STBD]: Starboard engine/propeller information
- [EngineREV PORT]: Port engine/propeller information
- [Weather]: Weather information
- [ROT]: Turning speed information
- [Current]: Tidal stream information
- [Azimuth Thruster]: Azimuth thruster information

Memo

Some buttons may not be displayed depending on the installation.

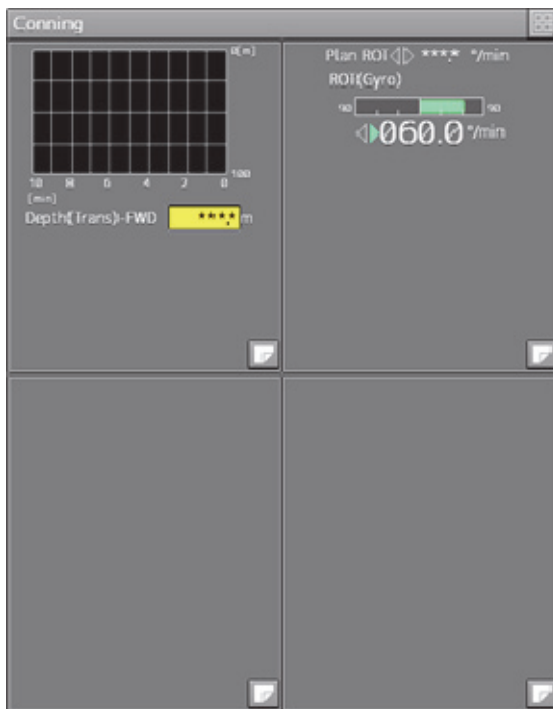

Example: [Depth] (water depth information) is displayed at the top left pane and [ROT] (turning speed information) is displayed at the top right pane (26-inch screen).

2.3.2 Information reference windows

By clicking on the buttons in the window, the contents that are displayed in the window can be switched.

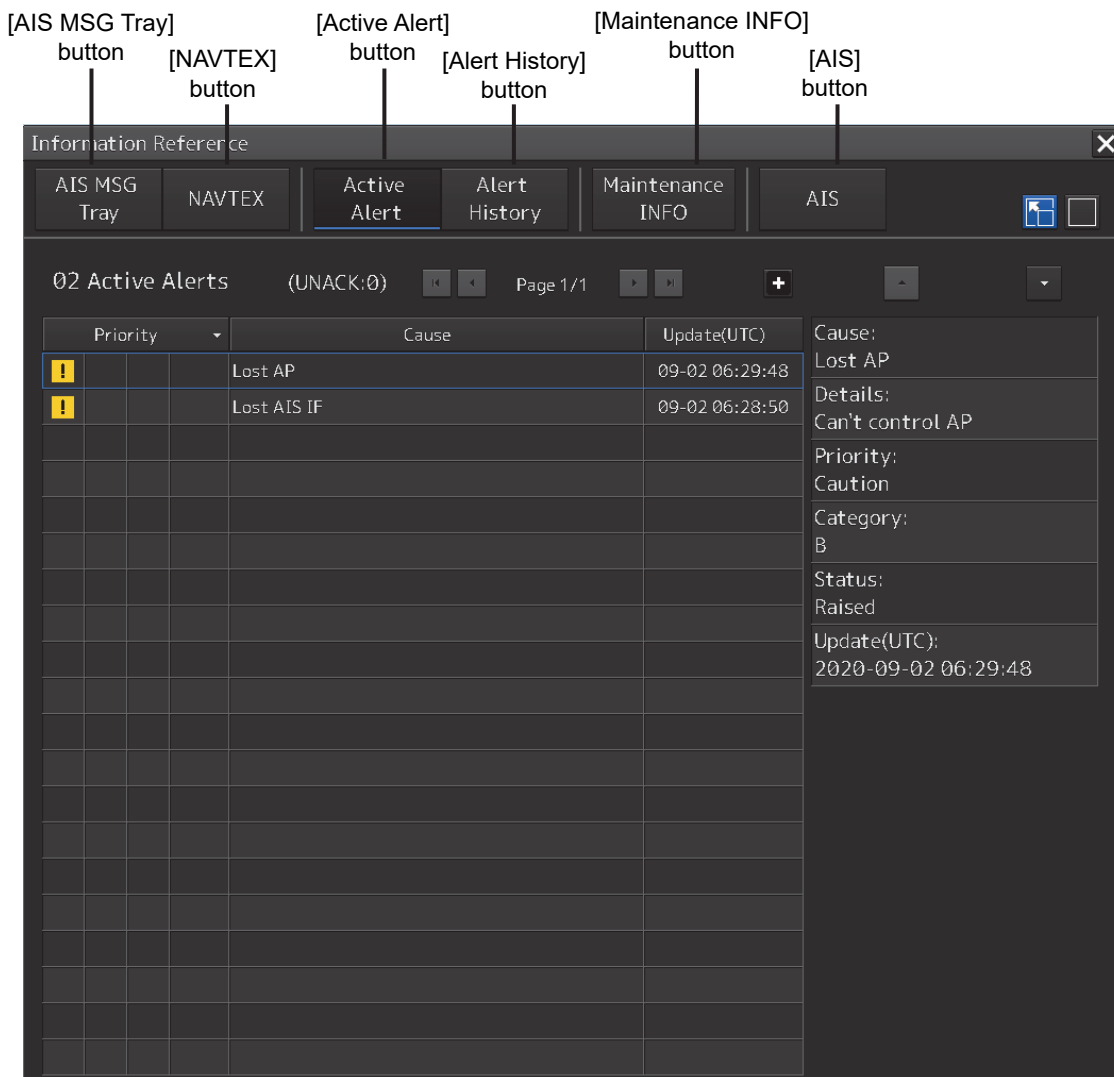

Example of Extended Display

Information reference related windows are listed below.

Button	Displayed content	Related section
[AIS MSG Tray]	AIS message tray	2.3.2.2 AIS MSG Tray
[NAVTEX] (Displayed only when NAVTEX is installed)	NAVTEX message	2.3.2.3 NAVTEX
[Active Alert]	Active alert that occurred in the equipment	2.3.2.4 Active Alert
[Alert History]	Alert history that occurred in the equipment	2.3.2.5 Alert History
[AIS]	Own ship's AIS information	2.3.2.6 AIS
[Maintenance INFO]	Maintenance information	2.3.2.7 Maintenance INFO

[Example of standard window]

A list screen and a detail screen are available for the standard window.

To switch to the detail screen: Click on the [Detail] button.

To switch to the list screen: Click on the [List] button.

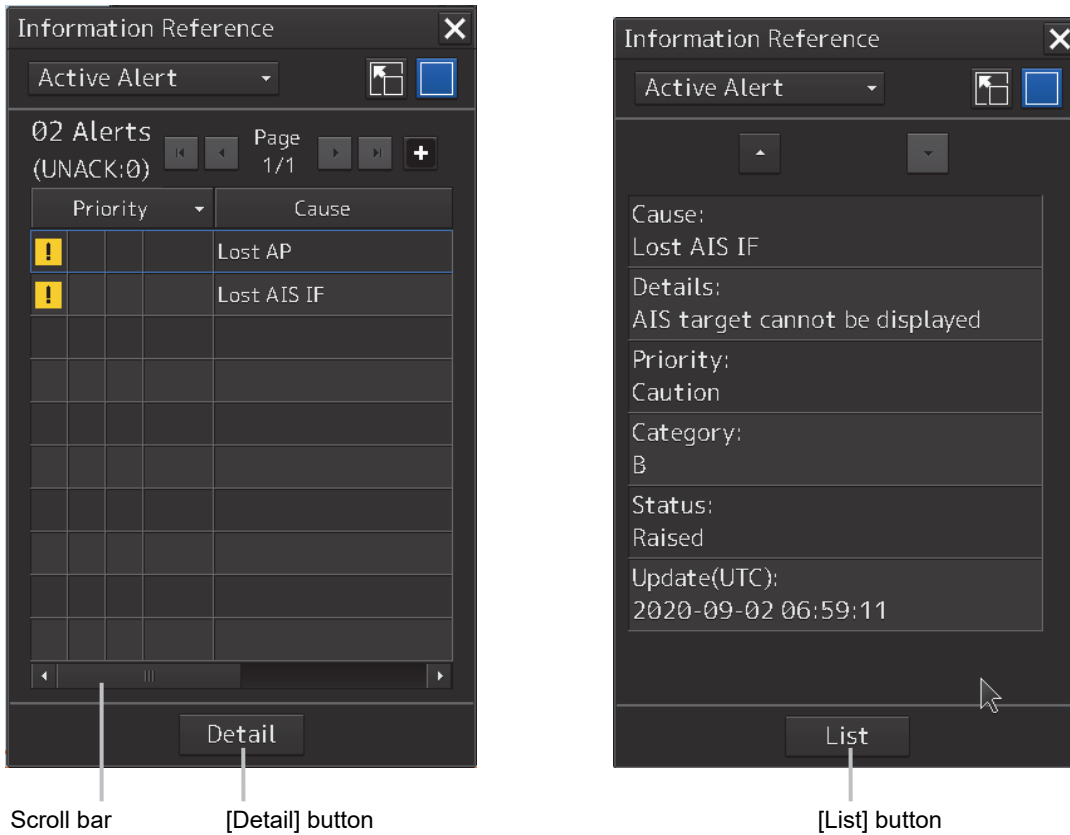

When the display contents overlap the top, bottom, left, or right side of the screen, a scroll bar is displayed.

By dragging the scroll bar, the overlapped section can be displayed.

Memo

At the initial display, a standard window is displayed during route monitoring and in other states, an expanded window is displayed.

2.3.2.2 AIS MSG Tray

AIS messages are displayed.

For the details of the AIS message tray, refer to "5.8 AIS Message Tray".

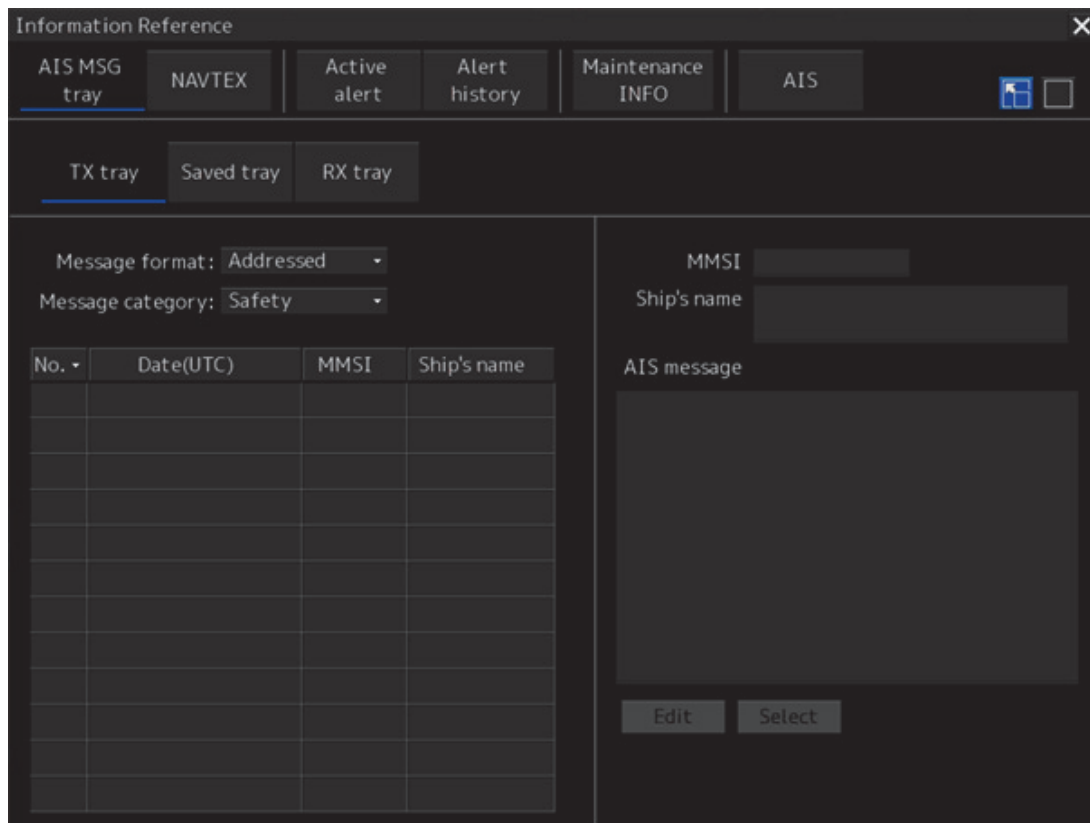

2.3.2.3 NAVTEX

The NAVTEX message is displayed.

This equipment supports the NAVTEX messages of the NMEA format and NAVTEX format.

The format that is used for displaying the NAVTEX messages is determined by the installation.

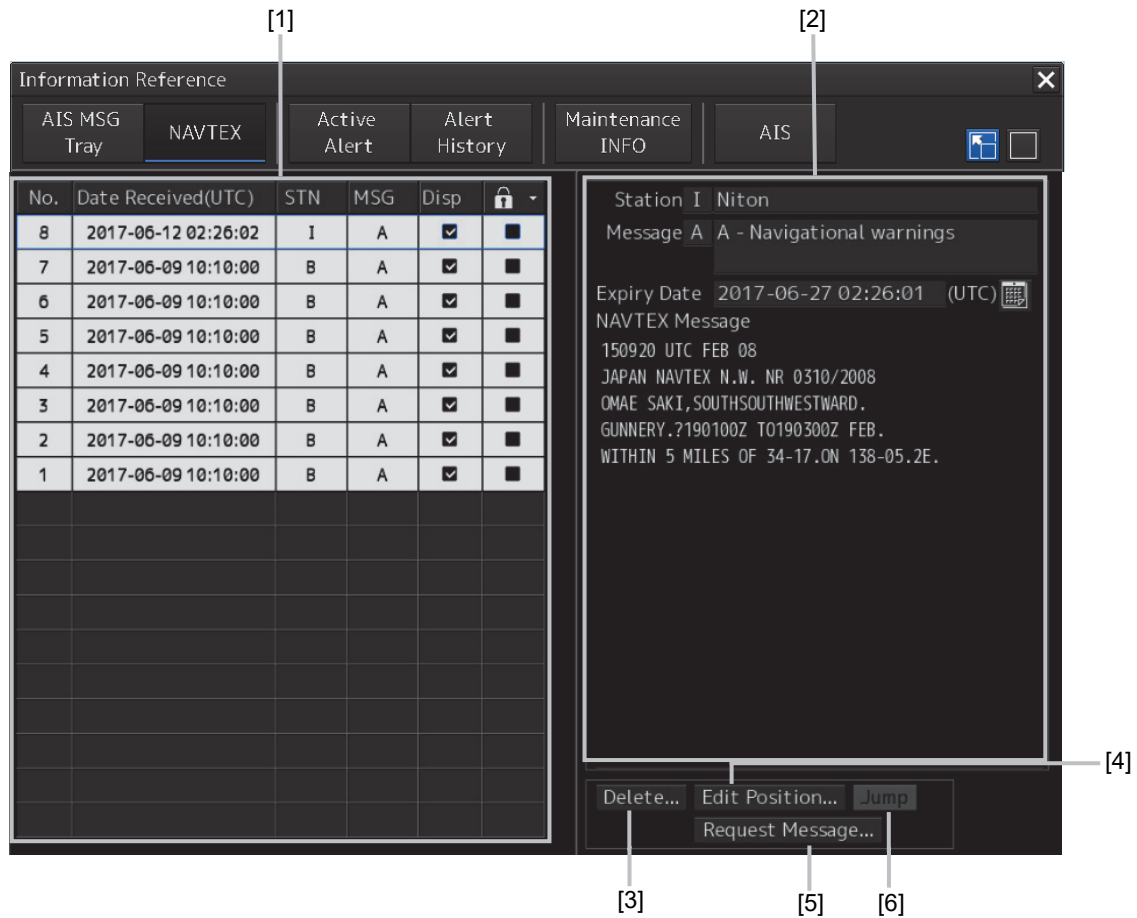

[1] NAVTEX message list

NAVTEX messages are listed. When a message line is clicked on, the details are displayed in "(2) Message details".

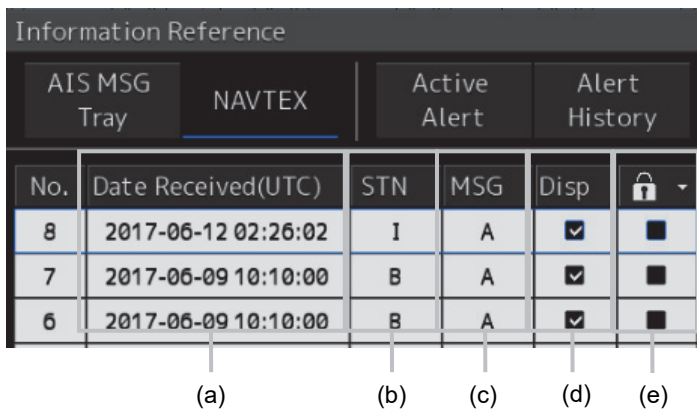

[a] Date Received

Displays a message received time.

[b] Station ID

Displays the message transmission source base station ID (A to Z).

[c] Message ID

Displays the message ID (A to Z).

[d] Disp check box

When this check box is checked, the symbol is displayed.

[e] Protect check box

When this check box is checked, the messages is protected.

Sorting a message list

When any of the items in the title line is clicked on, the messages are sorted based on the item.

No.	Date Received(UTC)	STN	MSG	Disp	
8	2017-06-12 02:26:02	I	A	<input checked="" type="checkbox"/>	<input type="checkbox"/>
7	2017-06-09 10:10:00	B	A	<input checked="" type="checkbox"/>	<input type="checkbox"/>
6	2017-06-09 10:10:00	B	A	<input checked="" type="checkbox"/>	<input type="checkbox"/>

[2] Message details

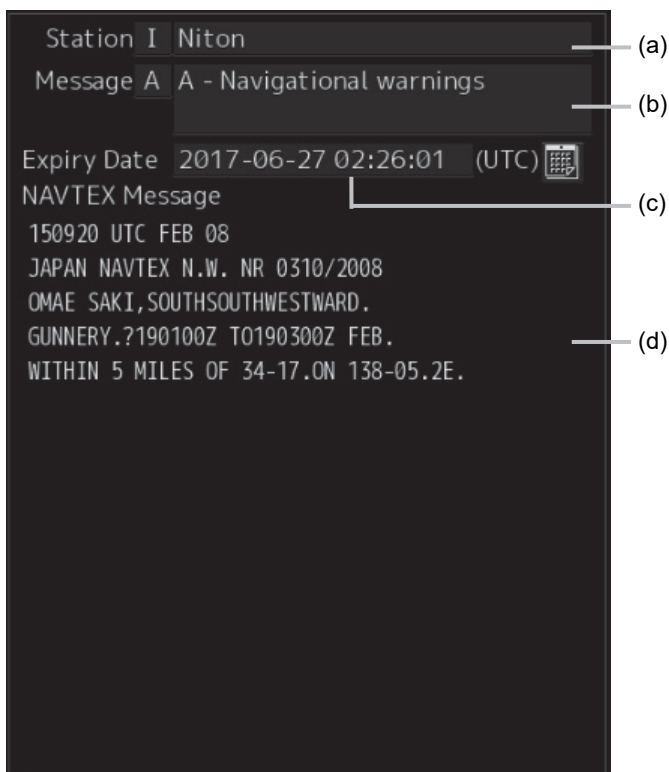

[a] Station ID

Displays the message transmission source base station ID (A to Z) and the name.

[b] Message ID

Displays the message ID and name.

[c] Expiration Date

Set the expiration date of the message.

- When the calendar icon  is clicked on, a calendar picker is displayed. Set the expiration date by using the calendar picker.
※The expiration date will be 15 days.

[d] NAVTEX Message

A message is displayed.

[3] [Delete...] button

When this button is clicked on, the [Delete] dialog is opened.

By using this dialog, a NAVTEX message can be deleted from the NAVTEX message list.

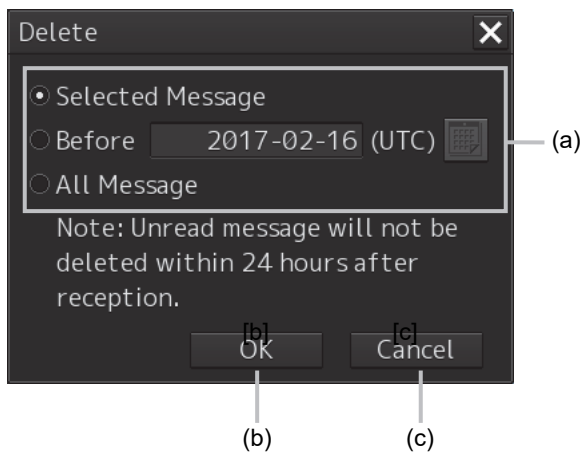
**[a] [Selected Message]/ [Before] (before the specified date) /[All Message](all the messages)**

Select a message to be deleted by clicking on the radio button.

When [Selected Message] is selected, the message that is selected from the NAVTEX message list is targeted for deletion.

When [Before] is selected, a calendar picker is displayed. Enter a date and click on the [OK] button. Messages on and before the specified date are targeted for deletion.

When [All Message] is selected, all the messages are targeted for deletion.

Caution

Unread messages within 24 hours after receiving can not be deleted.

[b] [OK] button

When this button is clicked on, the NAVTEX messages that are targeted for deletion are deleted.

[c] [Cancel] button

When this button is clicked on, the [Delete] dialog is closed without deleting the NAVTEX messages.

[4] [Edit Position...] button

When this button is clicked on, the [Location] dialog is opened.

In this dialog, edit the position data of the NAVTEX symbol that is displayed on the map.

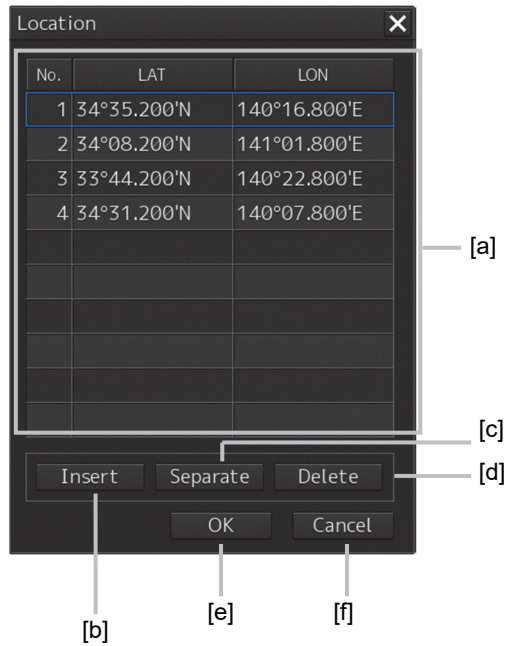

[a] Position data list

When the latitude or longitude of the position data is clicked on, a numeric input software keyboard is displayed.

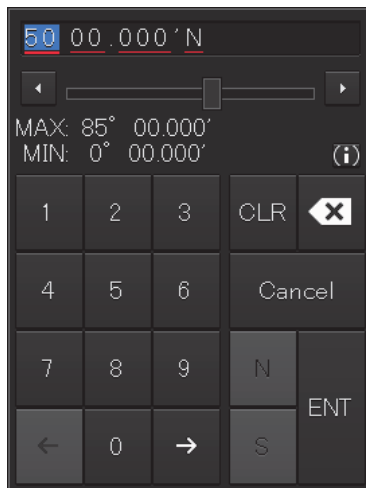

The position data can be changed by entering a latitude or a longitude.

Memo

The maximum latitude input range of Location is 85 ° 00.000 (polar range restriction).

[b] [Insert] button

Copies the selected row to the row following the row that is selected in the location data list.

[c] [Separate] button

Inserts a separator (-----) in the row following the row that is selected in the location data list.
Use the separator by improving the presentation of the position data list.

[d] [Delete] button

Deletes the row (location data or separator) that is selected in the location data list.

[e] [OK] button

Validates the editing of the location data and closes the [Location] dialog.

[f] [Cancel] button

Invalidates the editing of the location data and closes the [Location] dialog.

[5] [Request Message...] button

When this button is clicked on, the "NAVTEX Message Request" dialog is opened.

In this dialog, message transmission can be requested to the message transmission source.

Memo

When NAVTEX messages in NAVTEX format are to be displayed by the installation, the [Request Message...] button is not displayed.

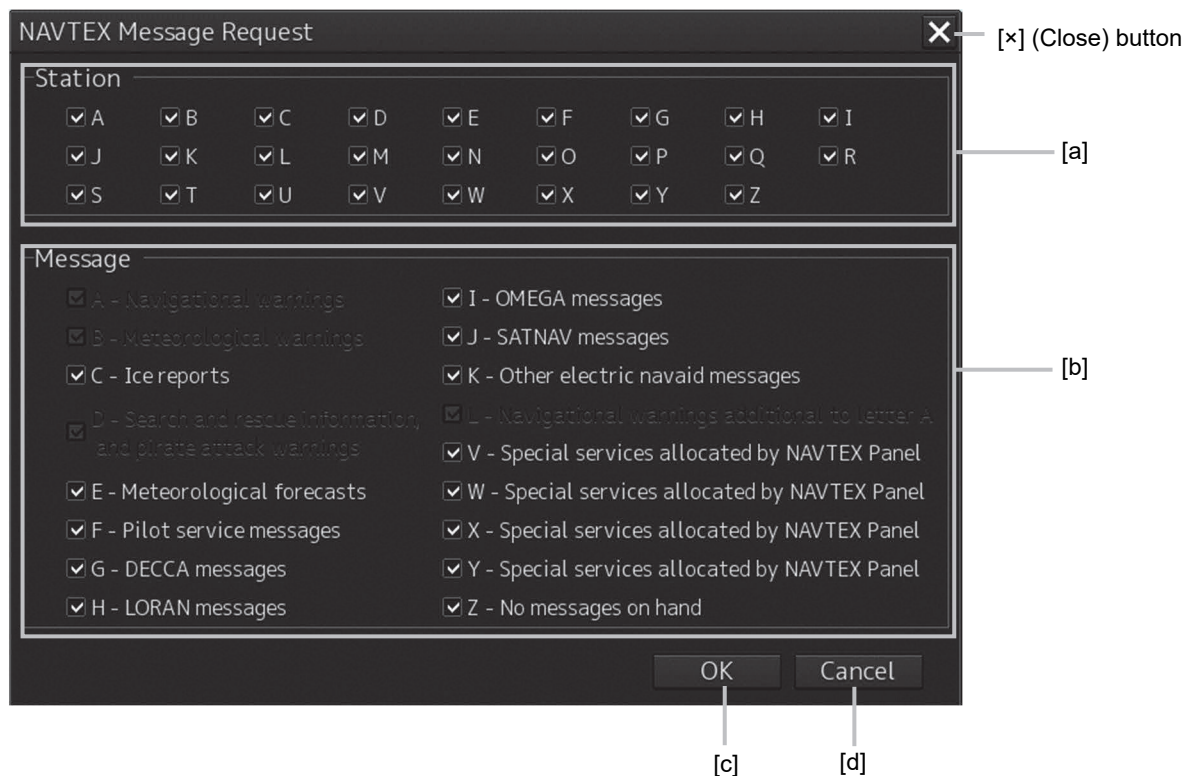
**(a) Base station ID**

Select to which base station message transmission is requested by checking the check box of the base station ID (A to Z).

(b) Message ID

Select a type of the message to be requested by checking the check box of the message ID.

(c) [OK] button

When this button is clicked on, transmission of the selected message is requested to the selected base station and the [NAVTEX Messages Request] dialog is closed.

(d) [Cancel] button

To close the [NAVTEX Messages Request] dialog without requesting message transmission, click on the [Cancel] button or [x] (Close) button.

[6] [Jump] button

When this button is clicked on, the NAVTEX symbol of the NAVTEX data that is selected from the NAVTEX message list is displayed on the chart.



Display example of the NAVTEX symbol

Memo

When the NAVTEX message contains any of the following latitude/longitude patterns, the NAVTEX symbol is displayed on the chart.

- dd-mm.mmf (Example: 35-35.50N)
- ddmm.mmf (Example: 3535.50N)
- dd mm.mmf (Example: 35 35.50N)
- dd mmf (Example: 35 35N)
- ddmmssf (Example: 353530N)
- dd-mm.mmmf (Example: 35-35.512N)
- dd-mmf (Example: 35-35N)
- dd-mm-ssf (Example: 35-35-30N)
- dd mm ssf (Example: 35 35 30N)

Legend: 'd'=degree, 'm'=minutes, 's'=seconds, 'f'=N/S, E/W

However, in case of Japanese NAVTEX it is not supported. The NAVTEX symbol will not be displayed on the chart.

2.3.2.5 Alert History

This window displays the history of alerts that occurred in this equipment.

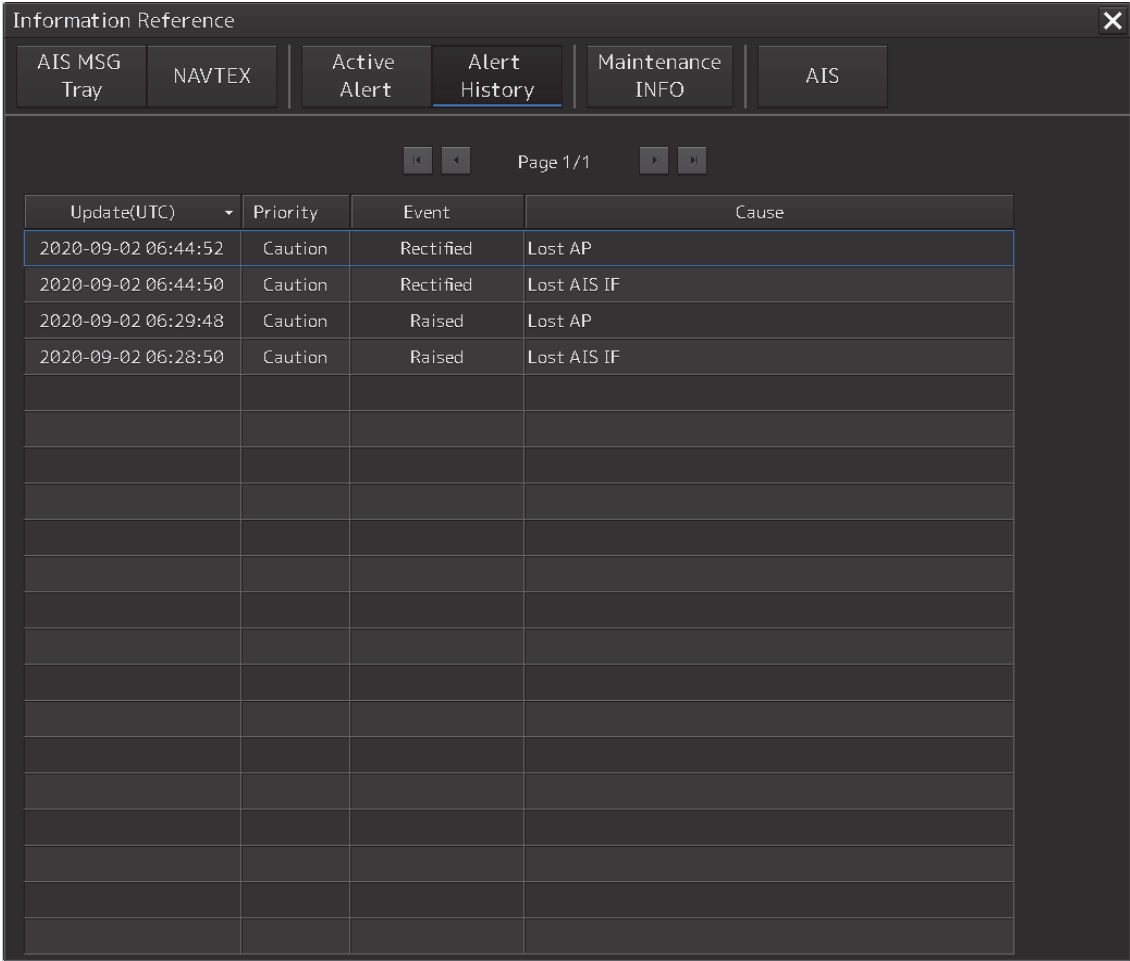

For the details, refer to "3.7.4 Displaying alert list and alert history".

Memo
The Alert History screen is displayed under the extended window only. A standard window is not available.

2.3.2.6 AIS

This window displays AIS information.

The AIS window includes the "Own Ship AIS Data" window that displays the AIS information of the own ship.

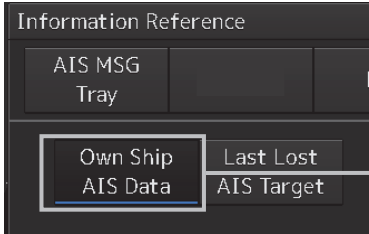

When the [Own Ship AIS Data] button is clicked on, the Own Ship AIS Data window is displayed.

Own Ship AIS Data window

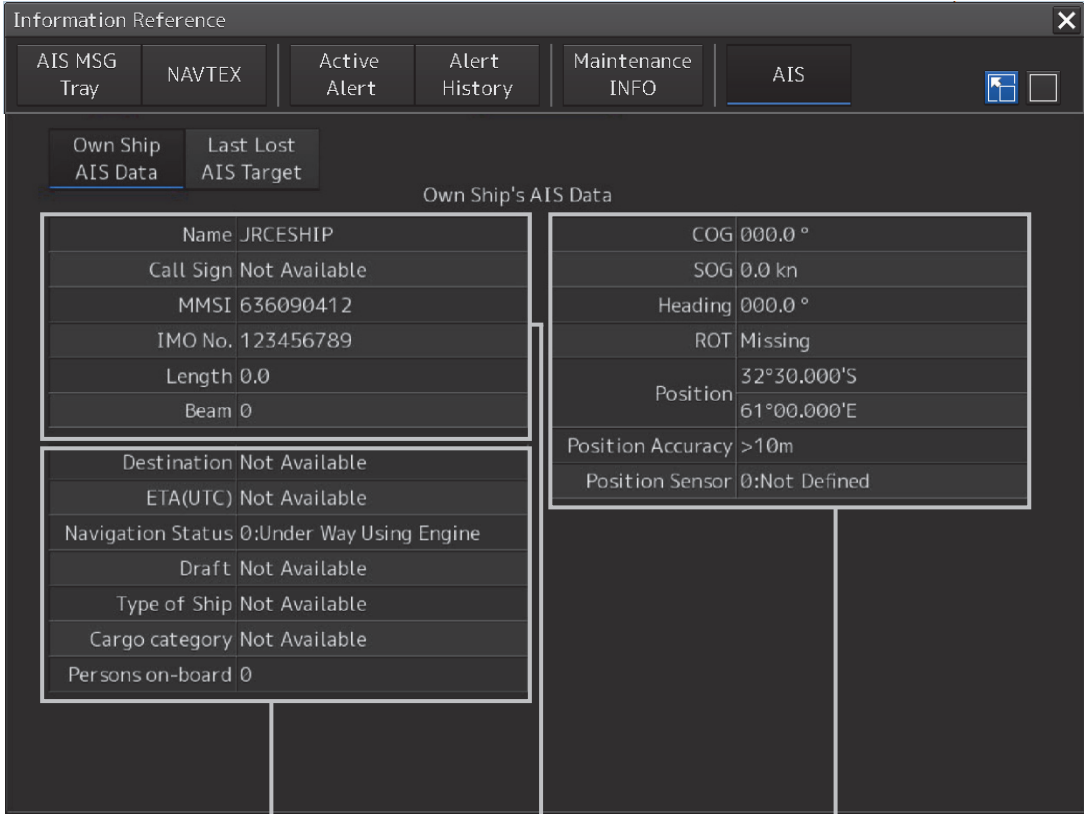

Static information that may be changed at navigation

Ship's specific static information

Dynamic information

For the details, refer to "5.11 Confirming Own Ship's AIS Information".

2.3.2.7 Maintenance INFO

Maintenance information are displayed.

For the details of the Maintenance INFO, refer to "19.9 Confirming Maintenance INFO".

Information Reference
✕

AIS MSG Tray

NAVTEX

Active Alert

Alert History

Maintenance INFO

AIS

12 Maintenance Informations
Page 1/3

Status	Cause	Raised(UTC)
!	SLC1-1(Communication failed, Mai...	2020-09-02 06:59:56
!	OPU-USB(Communication error)	2020-09-02 06:59:50
!	Gyro 1(Communication Failed, Mai...	2020-09-02 06:59:21
!	Gyro 1(Communication Failed, Dire...	2020-09-02 06:59:21
!	Multi Current(unavailable)	2020-09-02 06:59:12
!	Autopilot(Unavailable)	2020-09-02 06:59:11
!	Log 1(Communication failed, Main ...	2020-09-02 06:59:11
!	Autopilot(Communication Failed, ...	2020-09-02 06:59:11
!	Log 1(Communication failed, Direct)	2020-09-02 06:59:11
!	AIS(Communication failed, Direct)	2020-09-02 06:59:11
!	GPS 1(Communication Failed, Direct)	2020-09-02 06:59:11
!	Current(Communication failed, Ma...	2020-09-02 06:59:11
✓	Time(unavailable)	2020-09-02 06:59:12
✓	GPS 1(Communication Failed, Main...	2020-09-02 06:59:11
	Position(unavailable)	2020-09-02 06:34:12
	COG/SOG(unavailable)	2020-09-02 06:34:12
	DATUM(unavailable)	2020-09-02 06:34:12
	Gyro 1(Communication Failed, Mai...	2020-09-02 06:29:52
	Autopilot(Communication Failed, ...	2020-09-02 06:29:48
	Autopilot(Unavailable)	2020-09-02 06:29:48

Cause: SLC1-1(Communication failed, Main LAN)

Raised(UTC): 2020-09-02 06:59:56

Rectified(UTC): -



Details: Communication with SLC1-1 cannot be performed via Main LAN.

Export

Section 3 Basic Operations

3.1 Powering On and Starting

Turn on the power supply according to the following procedure.

 CAUTION	
	Do not leave the disc in the DVD drive. Malfunctions of the drives may result.
	For low-temperature start-up, perform pre-heat for more than 30 minutes. Otherwise, an operation failure may occur and an accident may occur.

Press the Power button on the operation unit.

The Power button is lit and the start-up screen is displayed.

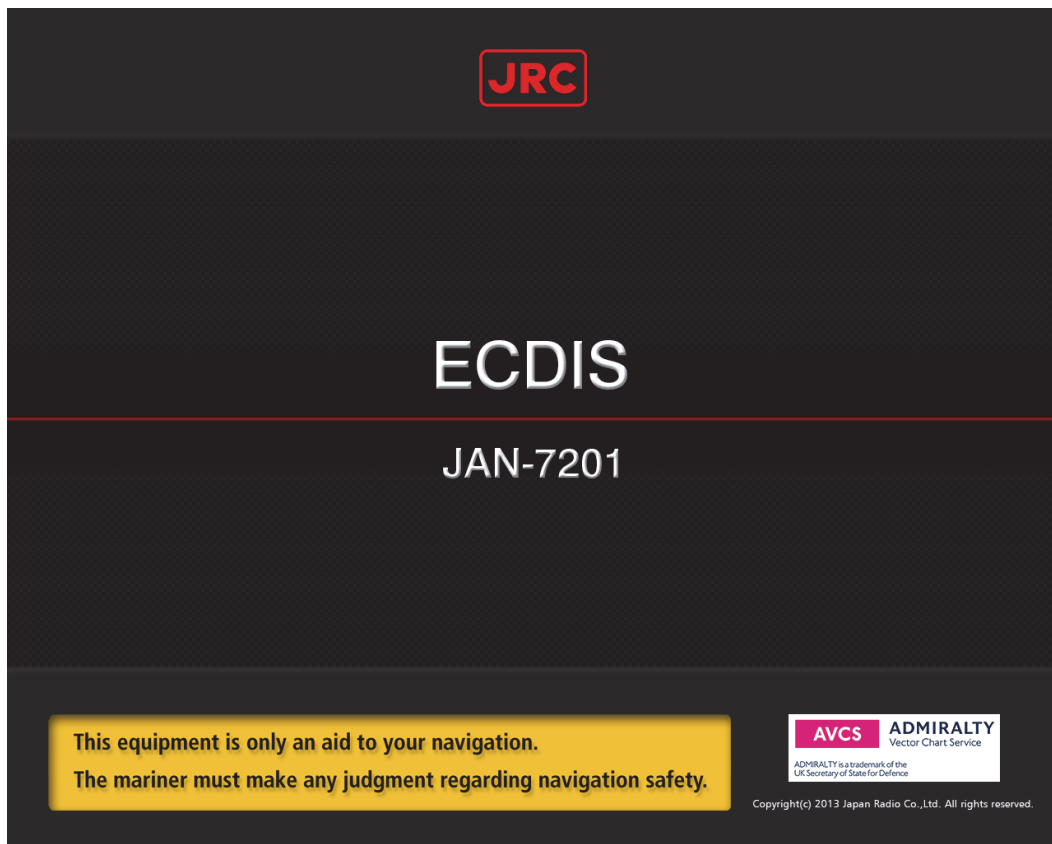

Memo

- At the center of the start-up screen, "RADAR" (in the case of RADAR), "ECDIS" (in the case of ECDIS), or "CHART RADAR" (in the case of CHART RADAR) is displayed depending on the type of the equipment.
- When the power is supplied while all the power supplies are disconnected, the indicator can be started automatically without pressing the Power button.

After the start-up screen is displayed, the task menu is displayed after a brief interval.

3.2 Starting Each Mode

When this equipment starts up, a task menu is displayed on the screen.

On the Task menu, you can select and start the desired mode from the operation modes available for this equipment.

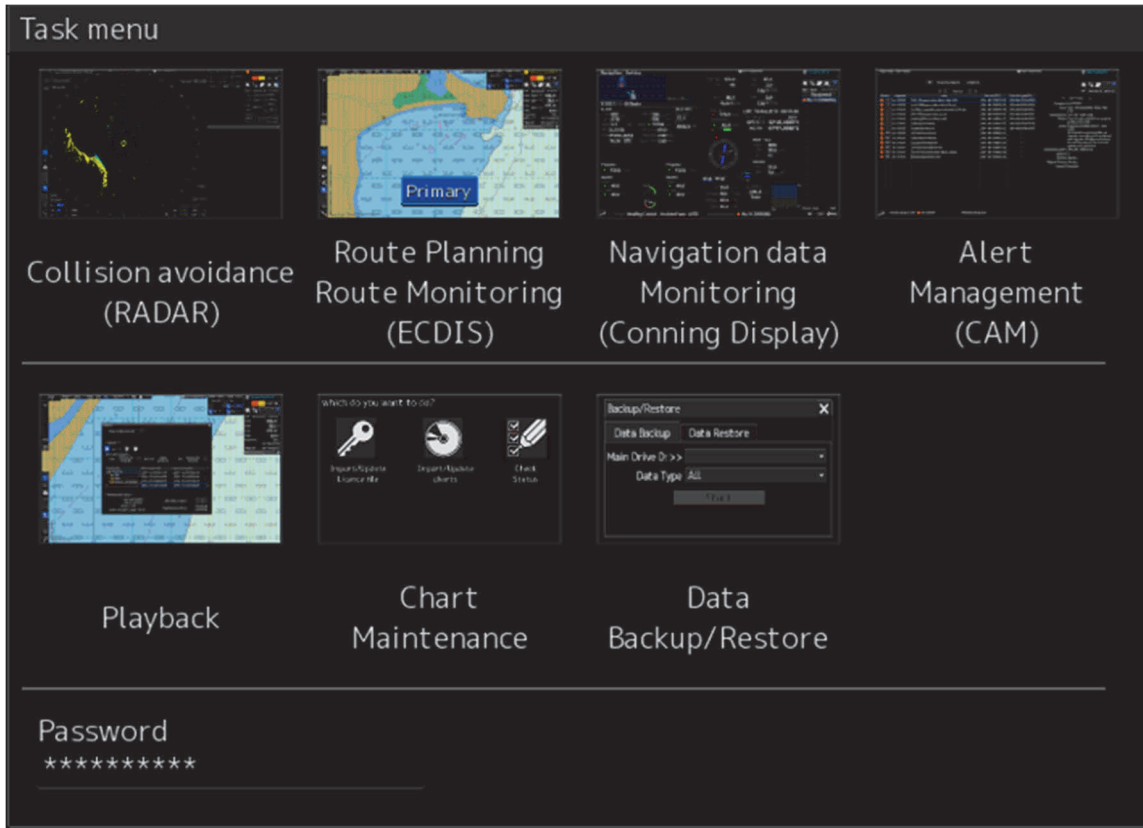

Task Menu Display Example

When the button of the mode to be executed is clicked on, the screen of the mode is displayed.

Note

When this equipment is started for the first time, if no operation is performed within 10 seconds after the task menu is displayed, the mode screen that has been set up at the time of shipment will appear.

Memo

Navigation Data Monitoring (Conning Display) is displayed as valid when Conning Display Device Licence is available. For the details of Conning Display, refer to “JAN-7202/9202 Conning Display Instruction Manual”.

Central Alert Management(CAM) is displayed as valid when CAM Device Licence is available. For the details of AMS, refer to “JAN-9202/7202 Bridge Alert Management System (BAMS) Instruction Manual”.

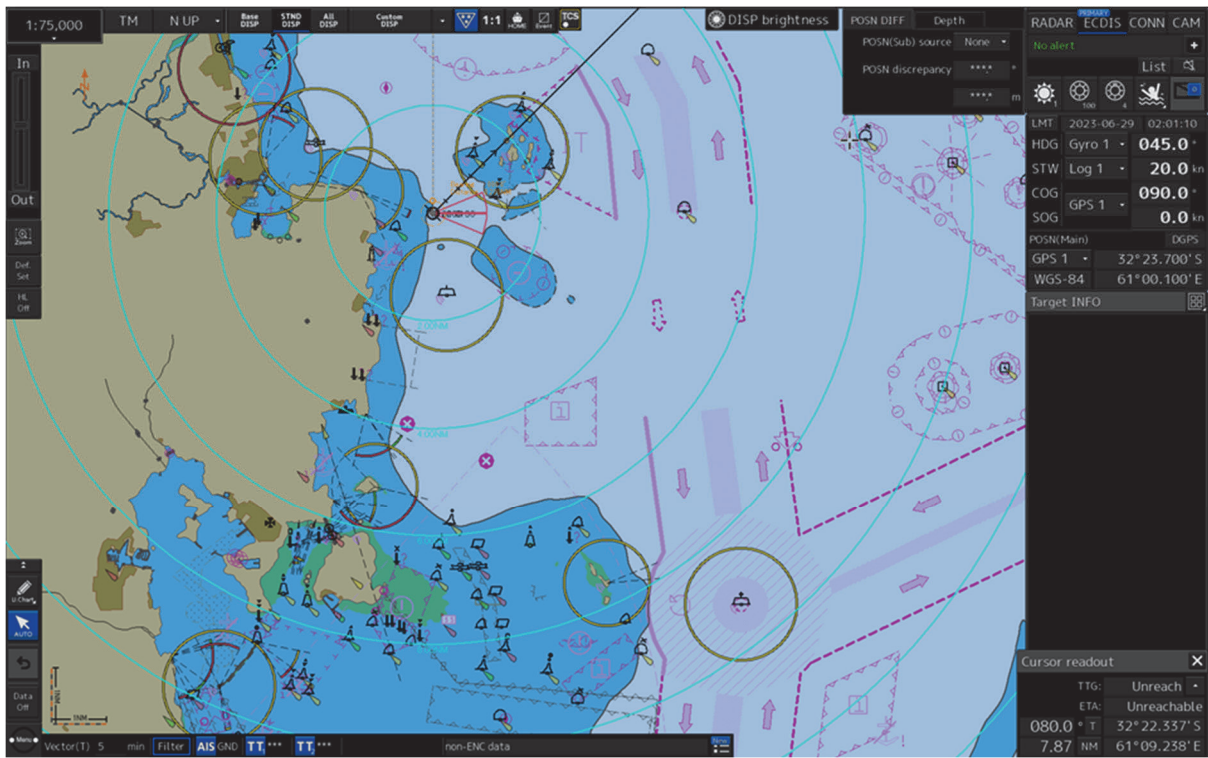

ECDIS

3.3 Basic Operations when using a Trackball

A trackball in the trackball operation unit is mainly used for the operations of this equipment. This section describes the basic operations performed using the trackball.

3.3.1 Basic trackball operations

As the basic trackball operations, move the cursor that is displayed on the screen and perform various operations using the left and right mouse buttons.

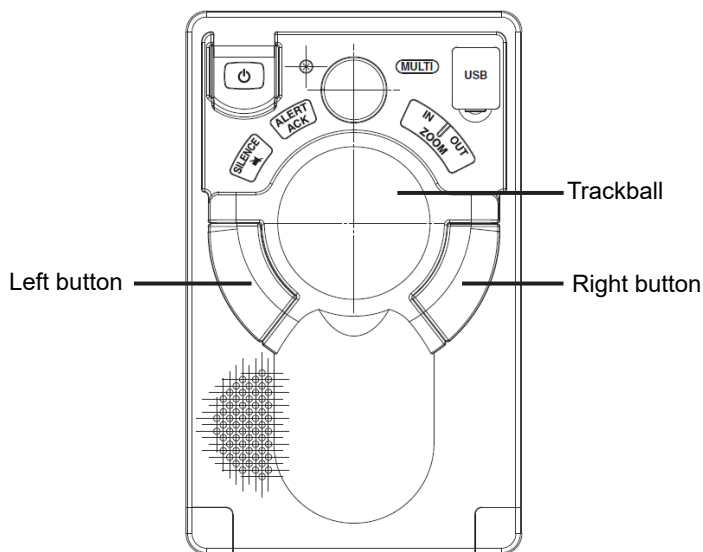

3.3.2 Basic click operations

3.3.2.1 Selecting a button

When the cursor is set to a button and the button is clicked on, the function of the selected button is executed.

- When a function On/Off button is clicked on, the setting is switched to On/Off each time.
- When a function selection button is clicked on, the function selection menu is displayed.

3.3.2.2 Selecting a single object

When the cursor is set to an object and the button is clicked on, the primary action (primary operation) related to the target object is performed.

For example, when the cursor is set to the sleeping AIS target and the button is clicked on, "Activate" which is the primary action of the sleeping AIS target is performed.

3.3.2.3 Selecting multiple objects

When the cursor is set to multiple objects and the button is clicked, a list menu of the target objects is displayed.

When an object is selected from the menu, the AUTO mode operation of the selected object is executed.



When the cursor is set to multiple objects and the right button is clicked, a target object list menu is displayed.

When an object is selected from the menu, the context menu of the selected object is displayed.

3.3.3 Basic operations of double-clicking

Double-click the button to end the creation mode in line creation mode or creation of a graphical route.

3.3.4 Basic operations of clicking the right button

When the cursor is positioned on the target object and the right mouse button is clicked, the context menu of the target object appears.

3.3.5 Displaying simplified information and operational guide of objects



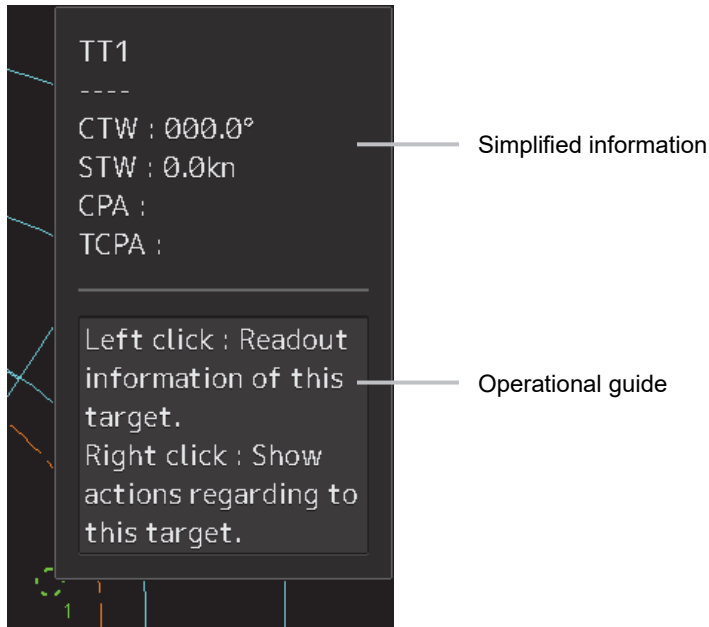









When the cursor is set to a specific object, the "simplified information" and "operational guide" are displayed.







When the cursor is moved, the display is cleared.

3.3.6 Cursor types

The following cursors are displayed by this equipment.

Cursor	Cursor Name	Description
	Pointer cursor	Indicates a position on the display panel, menu bar, dialog box, or context menu.
	Cross-hair cursor	Indicates a position on the chart. In AUTO mode, this cursor is used by an off-centering function.
	Hand cursor	Appears when the cursor is moved while pressing the left button on a chart. This function enables moving the position freely by dragging the chart.
	Zoom cursor	Appears when a zoom function is selected.
	Edit cursor	Moves an object in user chart/manual update/mariner's mark, or route graphic mode.
	Offset cursor	Appears when the offset of the ship's own position is set in adjustment cursor mode.
	Select cursor	Displays the position on the chart during the editing of the user chart/manual update/mariner's mark and route graphics.
	Mark cursor	Displayed at execution of User Chart/Manual Update/Mariner's Mark, route plan (addition of WPT), or Manual Position Fix.
	Chart selection cursor	Appears when the chart under the ENC/ARCS cursor is selected or Change Active Panel of ARCS is set.
	Arrow cursors	Appear when any of the following operations is performed. <ul style="list-style-type: none"> • EBL/VRM, AIS filter, AZ, PI • User chart/manual update • Moving the multi-view bar • Operation of EBL, VRM
	Rotation cursor	Appears at PI operation or in route rotation mode of route planning.
	Eraser cursor	Appears in eraser tool mode.
	Target activation cursor	Appears when the cursor is moved over a sleeping AIS target.

Cursor	Cursor Name	Description
	Numeric displayed AIS target cursor	Appears when the cursor is moved over an activated AIS target or TT.
	Numeric displayed AIS target cancellation cursor	Appears when the cursor is moved over an AIS digital information target or a TT digital information target.
	Pointer cursor	Appears when the cursor is moved over a hyperlink.
	Move cursor	<ul style="list-style-type: none"> • Appears during the dialog box move mode. • Appears when moving an intersection point of EBL/VRM. • Appears when moving Node Fixed EBL/VRM.
	EBL cursor	Appears at EBL maneuver is created.

3.4 Basic Menu Operations

Various functions can be executed or set from the menu that is displayed by clicking on the [Menu] button.

This section describes the basic menu operations.

3.4.1 Opening the menu

- 1 Click on the [Menu] button on the left toolbar.



The menu is displayed.

The menu screen comprises two pages.

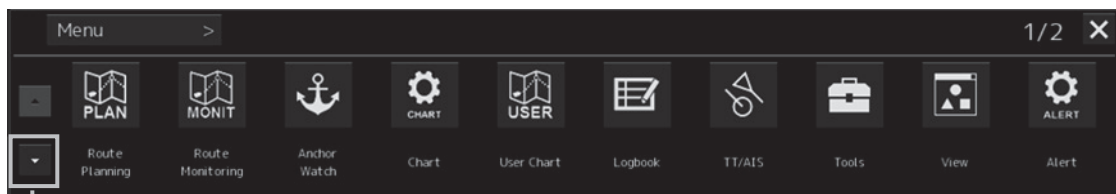

Page switching button:

Switch the menu screen by clicking on the button.

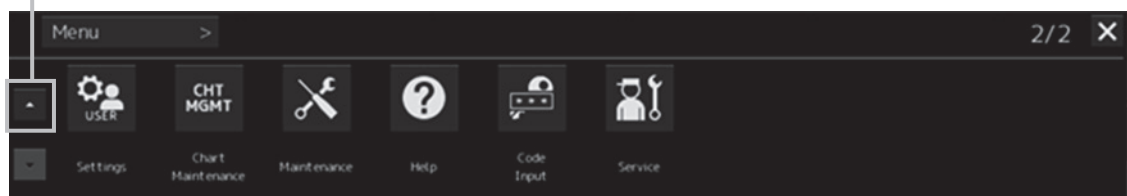

2 Click on one of the buttons that are displayed on the menu.

A dialog box for executing or setting the applicable function appears.

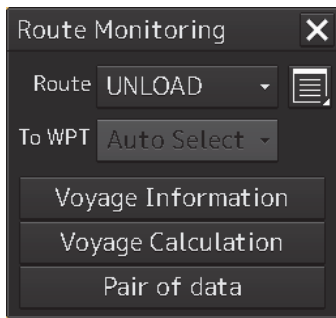

Display Example

3 A submenu is displayed depending on the function. In this case, display a dialog box of the function by clicking on the button on the submenu.

Example: TT/AIS

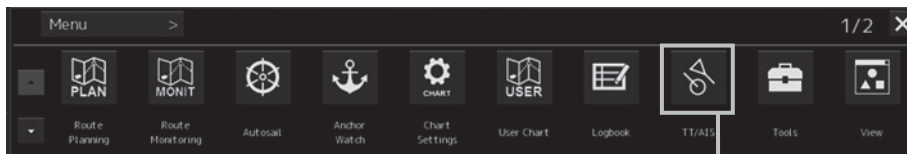

Top menu of TT/AIS

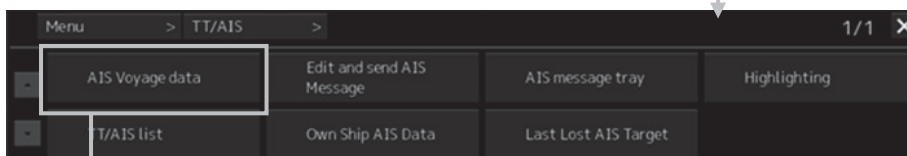

Submenu of TT/AIS

When the submenu screen extends over two pages, similar to the menu screen, it is possible to switch between the pages using the page change buttons.

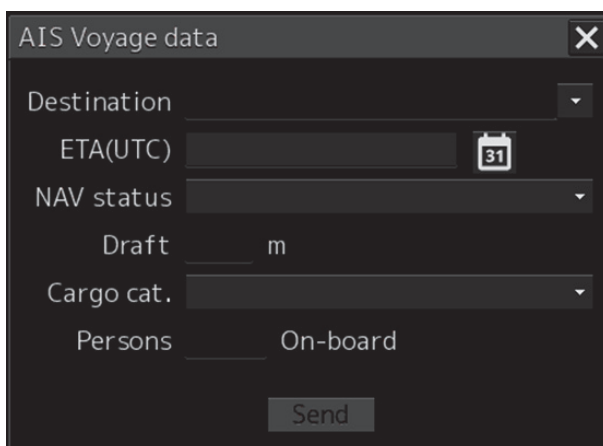

- 4 Some functions comprise a classification pane and an edit pane and a dialog is available to hide the classification pane by using the Disclosure button.

Example: "User Settings" is clicked on the menu.

Disclosure button

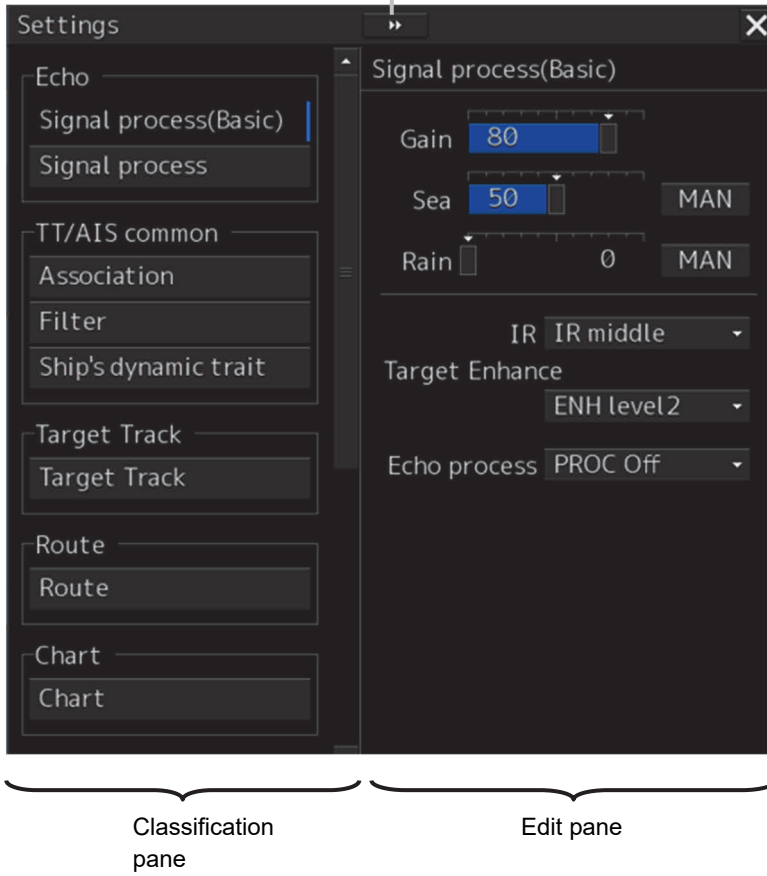

Hiding the classification pane

3.4.2 Menu list

The menus that are displayed vary according to the task that is currently being executed.

Menu	Related section
Route Planning	Section 7 Route Planning
Route Monitoring	Section 8 Route Monitoring
Anchor Watch	Section 9 Monitoring a Dragging Anchor
Autosail* ¹	Section 10 Automatic Sailing (Option)
Chart	Section 11 Operating a Chart
User Chart	Section 12 Creating a User Chart/Updating a Chart
Logbook	Section 13 Logbook
TT/AIS	Section 5 Target Tracking and AIS
Tools	-
View	Section 14 Setting Up Screen View
Alert	Section 15 Setting Up Alerts
Settings	Section 16 Setting Up the Operation Mode
Chart Maintenance	11.15 Maintaining a Chart
Maintenance	19.1 Maintenance Functions Executed from Menu
Help	3.18 Help
Code Input	3.19 Password Input
Service	Section 17 Adjusting and Setting Up Equipment (for Services)

*1 Displayed when the automatic sailing option is attached.

3.4.3 Closing the menu

Click on the [X] button on the menu (submenu).

3.5 Basic Dialog Box Operations

When a dialog box is opened, the dialog box is in the factory setting state or state at termination of the previous operation.

The setting can be changed by the following operation.

- Enter a character or a value in the input box.
- Select a setting from the list.
- Select a setting by clicking on the button.
- Select a setting by checking or unchecking the check box.

3.5.1 Changing dialog box settings

This section describes the basic setting change procedure by using the "Edit and Send AIS Message" (AIS message editing/transmission) dialog box as the example.

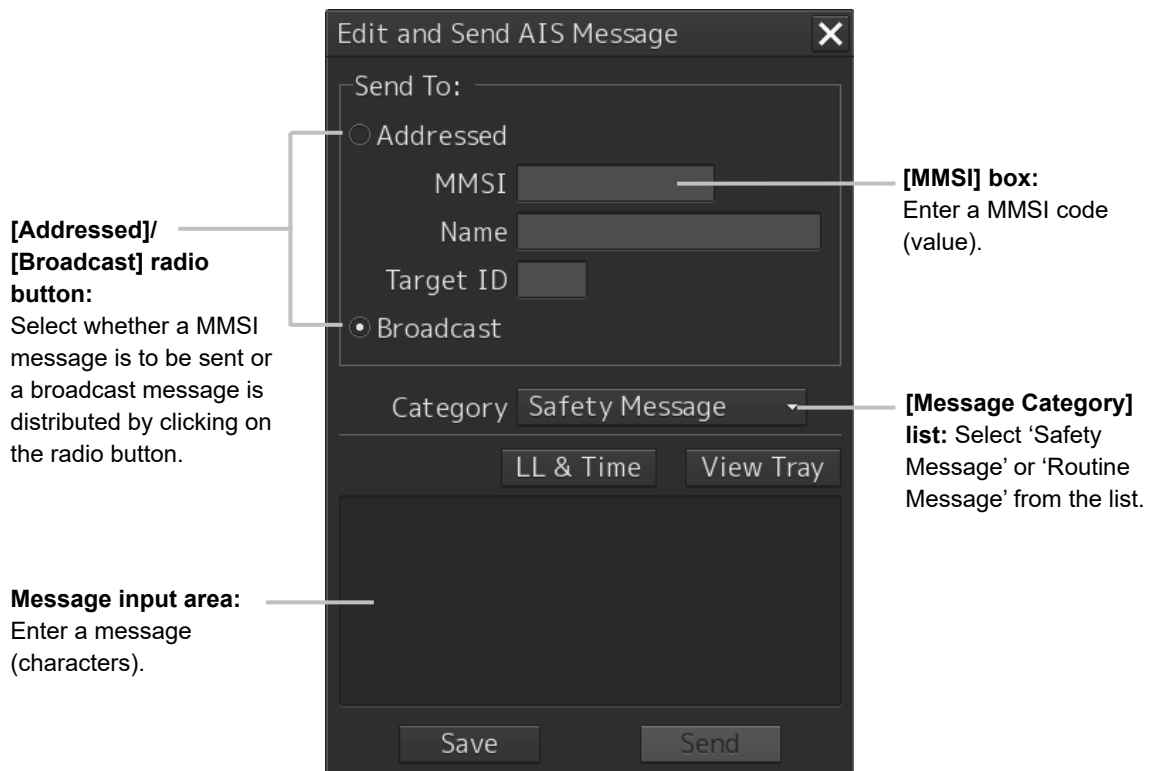

A function may also be set by opening another dialog box from the dialog box.

File operation dialog box display button:

When this button is clicked on, the "File operation" dialog box is opened.

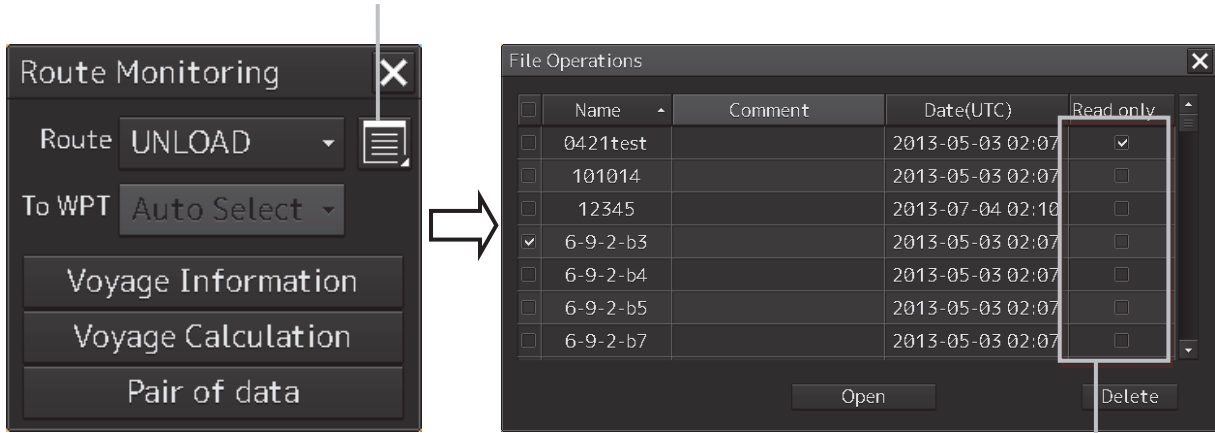

[Read only] check box:
Specify the file as Read Only by checking the box by clicking.

3.5.2 Closing a dialog box

Close the dialog box by clicking on the [X] (Close) button on the dialog box.

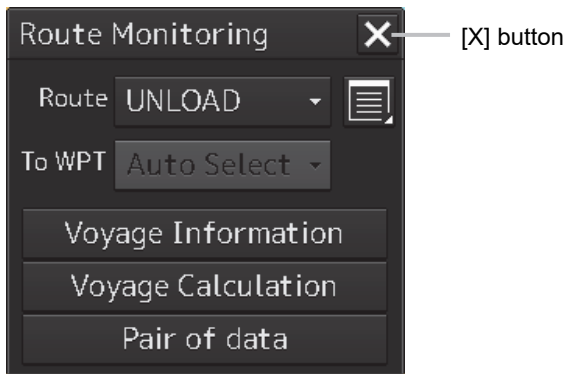

Memo

When no operation is performed for one minute after a dialog*1 is displayed, the dialog is closed automatically. When a different dialog is displayed in any of the following cases, the dialog that is currently displayed is closed automatically.

- Automatic sailing or route monitoring is carried out in ECDIS mode.
If setting/editing operation has not been completed when the dialog is closed automatically, the editing contents are discarded.

*1 The following dialogs are excluded from the targets.

Information monitoring window, information reference window, route monitoring (including Voyage Information, Voyage Calculation, and Pair of data), MOB

3.5.3 Title Bar

The name (title) of the dialog box is displayed on the title bar of the dialog box.

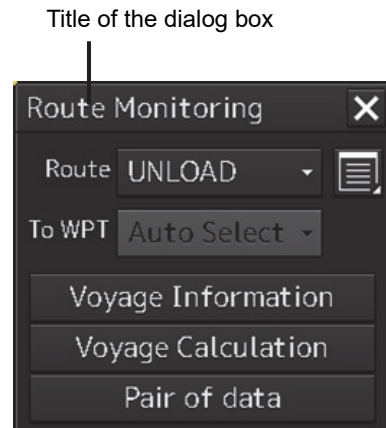

The dialog can be moved by dragging the title bar.



WARNING



When moving the dialog box, move to the position that does not cover the operation area. If the dialog box covers the operation area, it may interfere the recognition of the display information.

Memo

Operation area and user dialog area

User dialog area

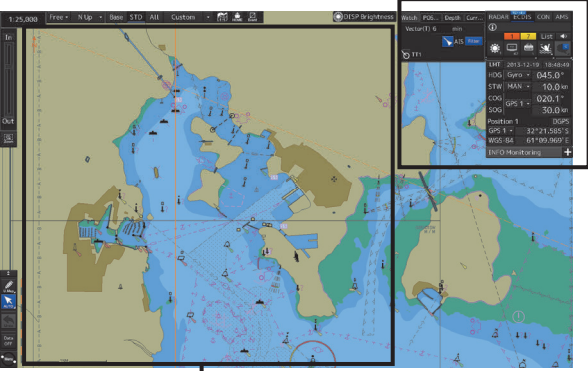

Operation area

3.6 Operation of the Information Monitor Window

This section describes the operation and editing of the information monitor window. For the details of the information monitor window, refer to "2.3 Common Information Window".

3.6.1 Opening the information monitor window

- 1 Click on the page switching button on the initial display window. In the initial display, a blank window appears.

The "Page Selection" dialog box appears by clicking on the page switching button.

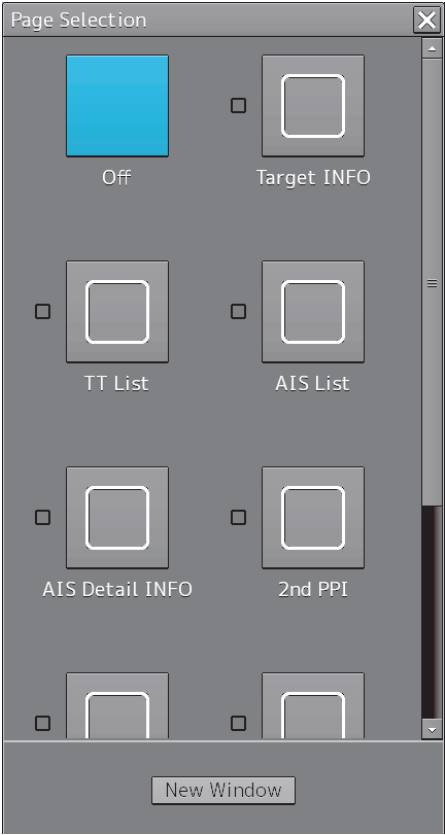
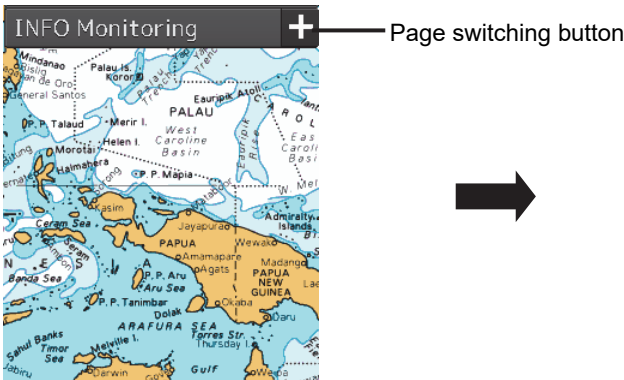

2 Click on the monitor information to be displayed. The applicable window is opened.

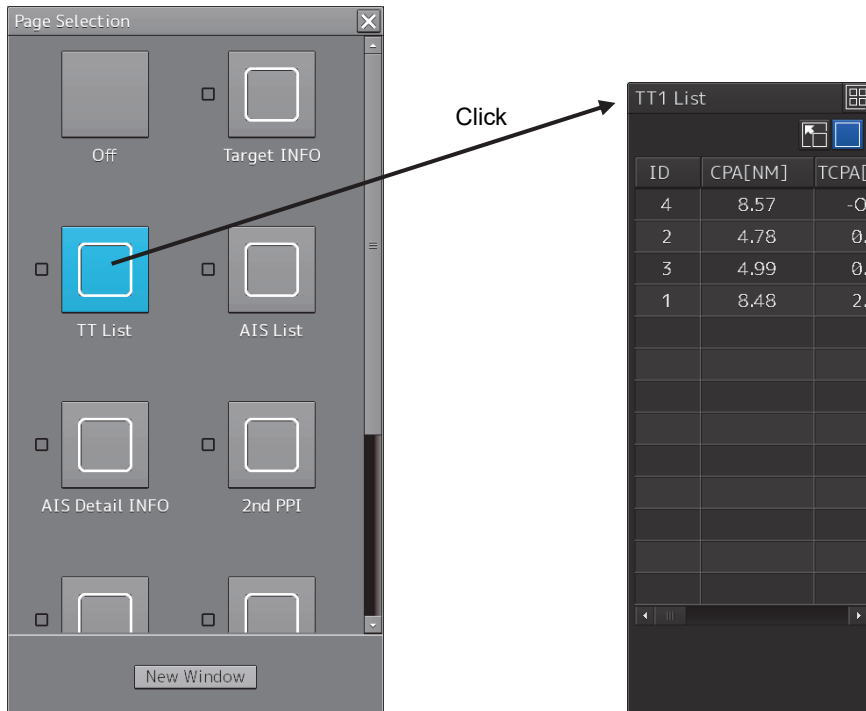

Example: Selecting the "TT1 List" in the RADAR

Returning to the "Page Selection" dialog box from each window

When the page switching button on each window is clicked on, control returns to the "Page Selection" dialog box.

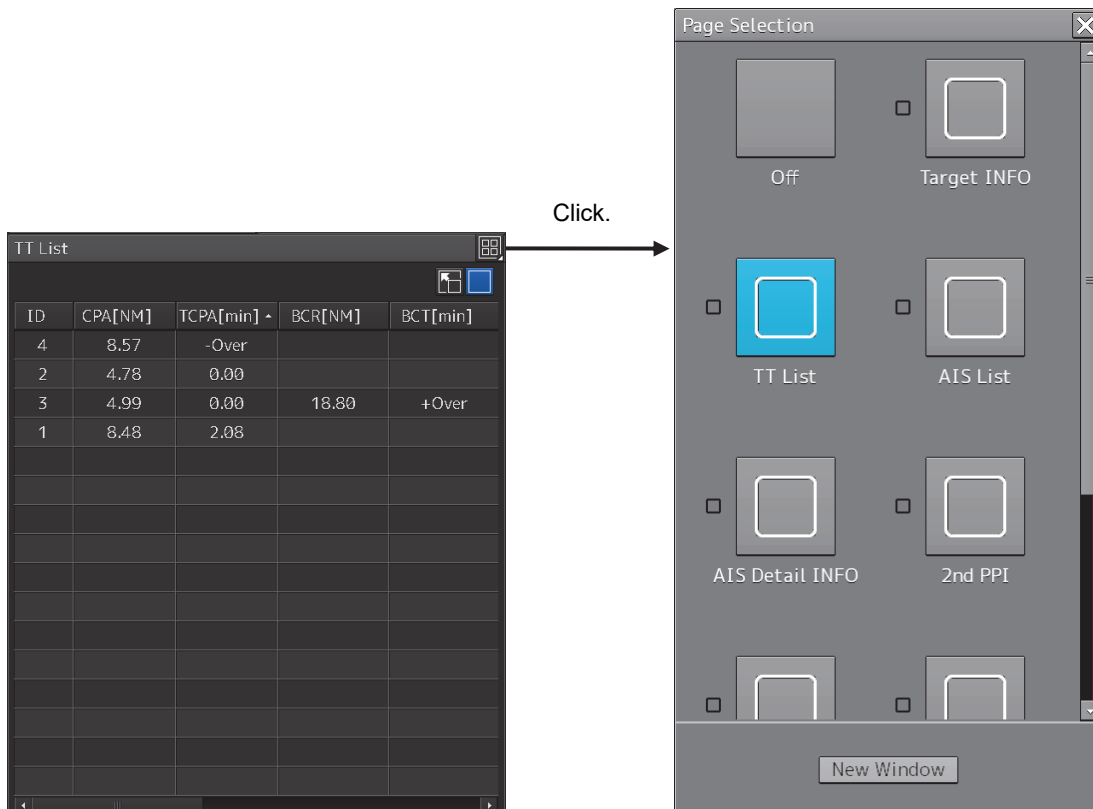

Example: Returning control from TT1 List

Setting another window for the item

- 1 Select the checkbox for the item for which another window is to be set.
- 2 Click on the [New Window] button.
The item is displayed on another window.

Memo

The window that is already displayed cannot be set to another window.

3.6.2 Displaying an information monitor window from other than the "Page Selection" dialog box

Use the following procedures to display an information monitor window from a display other than the "Page Selection" dialog box.

Information monitor window	Display method
Target INFO	<ol style="list-style-type: none"> 1) Click on the TT symbol. (Cursor AUTO mode) 2) Click the right button on the TT/AIS symbol and select Readout information from the context menu. 3) Click on the AIS Active target. (Cursor AUTO mode)
TT1 List, TT2 List	<ol style="list-style-type: none"> 1) Select TT/AIS List from [TT/AIS] on the menu.
AIS List	<ol style="list-style-type: none"> 1) Select TT/AIS List from [TT/AIS] on the menu.
AIS Detail INFO	<ol style="list-style-type: none"> 1) Select one AIS target from the AIS List and click on the Details button. 2) Click the right button on the AIS symbol, and select Readout detail information from the context menu.

3.7 Confirming and Acknowledging an Alert

When an alert is generated, a buzzer sound is emitted and an alert balloon is displayed in the alert notification area.

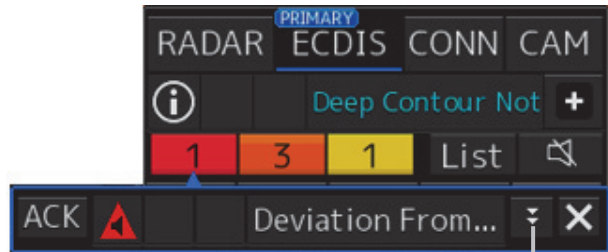

Example of Balloon Alert

Disclosure button

To acknowledge the alert detailed information, click on the Disclosure button.
For the details of the subsequent operations, refer to "3.7.2 Confirming alert contents".

The general procedure for handling an alert is shown below.

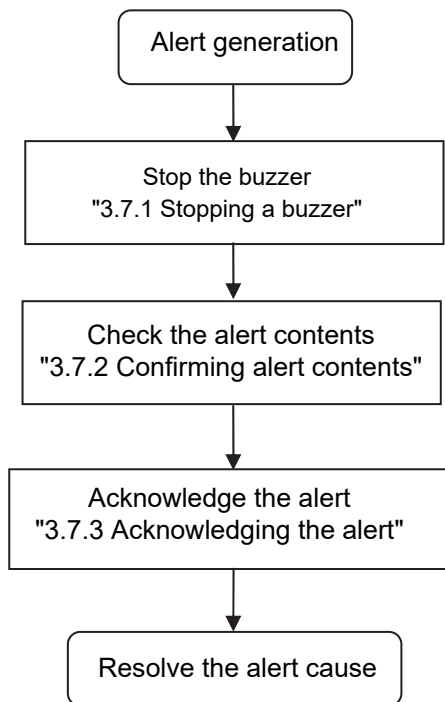

3.7.1 Stopping a buzzer

To stop a buzzer (silencing), click the silence button in the alert notification area or press the [SILENCE] key in the trackball operation unit.

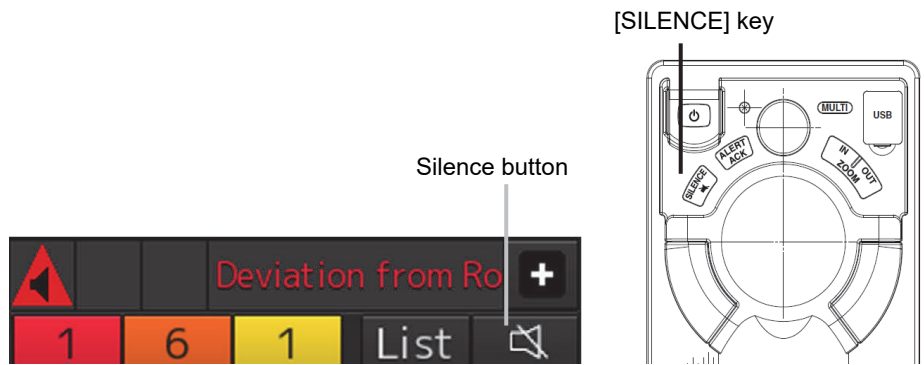

3.7.2 Confirming alert contents

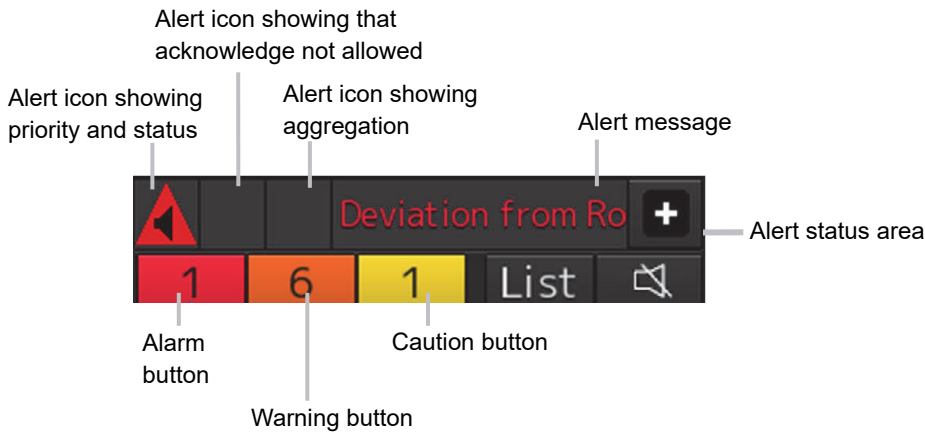

Display Example when an Alert is Generated



Display Example when No Alert is Generated

When an alert is generated, the alert message is displayed in the "Alert status area". The alert type and the number of alerts are displayed by the button.



- Alarm button: Displayed when an alarm is generated. The button is displayed in red. The number of alarms is indicated on the button.
- Warning button: Displayed when a warning is generated. The button is displayed in orange. The number of warnings is indicated on the button.
- Caution button: Displayed when a caution is generated. The button is displayed in yellow. The number of cautions is indicated on the button.

1 Click on the button.

An alert balloon is displayed.

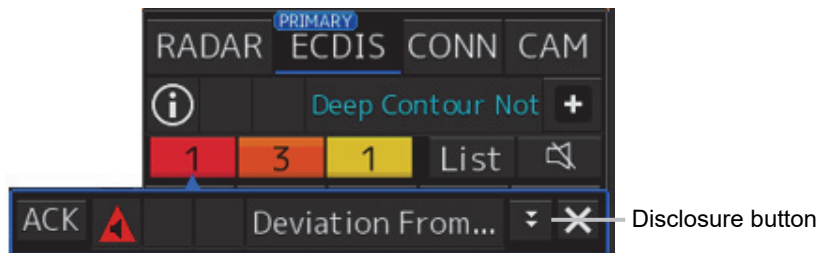

2 Display the alert detail dialog by clicking on the Disclosure button.

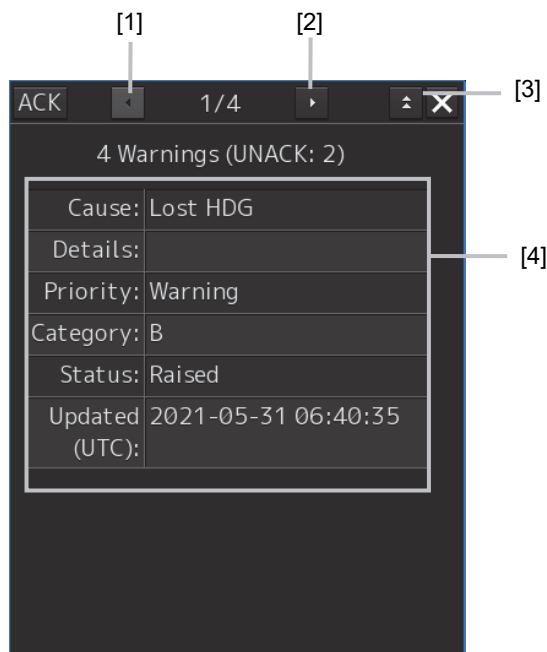

[1] [Higher] button

When the Higher button is clicked on, details of the alerts of the higher priority than the alert currently displayed appear.

[2] [Lower] button

When the Lower button is clicked on, details of the alerts of the lower priority than the alert currently displayed appear.

[3] Disclosure button

When the Disclosure button is clicked on, the original alert balloon is displayed.
As a result, the Own Ship Information that was hidden can be reconfirmed.

[4] Detail information

Cause (Cause), Status (Status), date and times (Updated), details (Details), category (Category) and priority (Priority) to be taken are displayed.

Memo

About Information:

Information is displayed in addition to a warning or a caution in the alert status area.

Information is used to report operation errors and so on to the users.

Unlike other alerts, no detail display is provided for Information.

3.7.3 Acknowledging the alert

After the [ACK] (acknowledgement) button of the alert detail display dialog box is clicked on or the [ALERT ACK] button of the trackball operation section is pressed after verification of the alert contents, the alert that is currently displayed is acknowledged.

When there are multiple alerts, perform the same operation by displaying the details dialog box of another alert.

When all the alerts are approved, the alert detail display dialog is closed automatically.

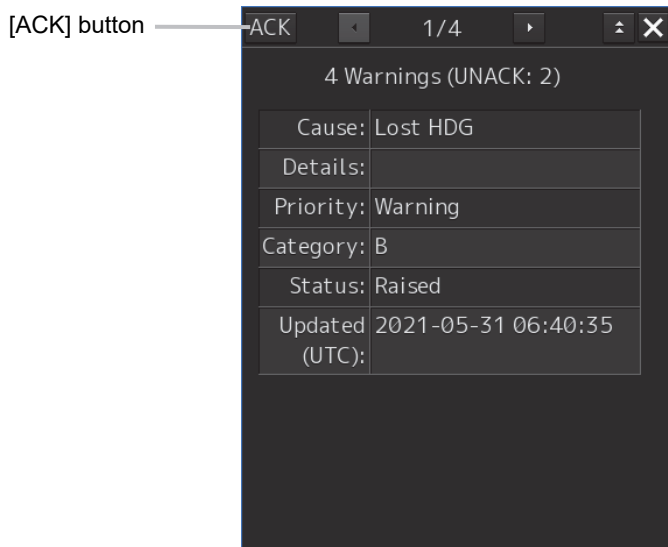

Memo

An alert can also be acknowledged by clicking on the [Active Alert] tab - [ACK] button of the [Alert List] dialog box.

For the details, refer to "3.7.4 Displaying alert list and alert history".

3.7.4 Displaying alert list and alert history

When an alert list button is clicked on, the [Alert List] dialog box of the common information window is displayed.

Memo

The common information window can be switched to either the standard window display or the enlarged window display.

This section uses the enlarged window in the example.

For the details of switching between the standard window and the enlarged window, refer to "2.3.2.1 Switching between a standard window and an extended window".

In the [Active Alert] tab, a list of the current alerts is displayed. In the [Alert History] tab, a list of past alerts that have been resolved is displayed.

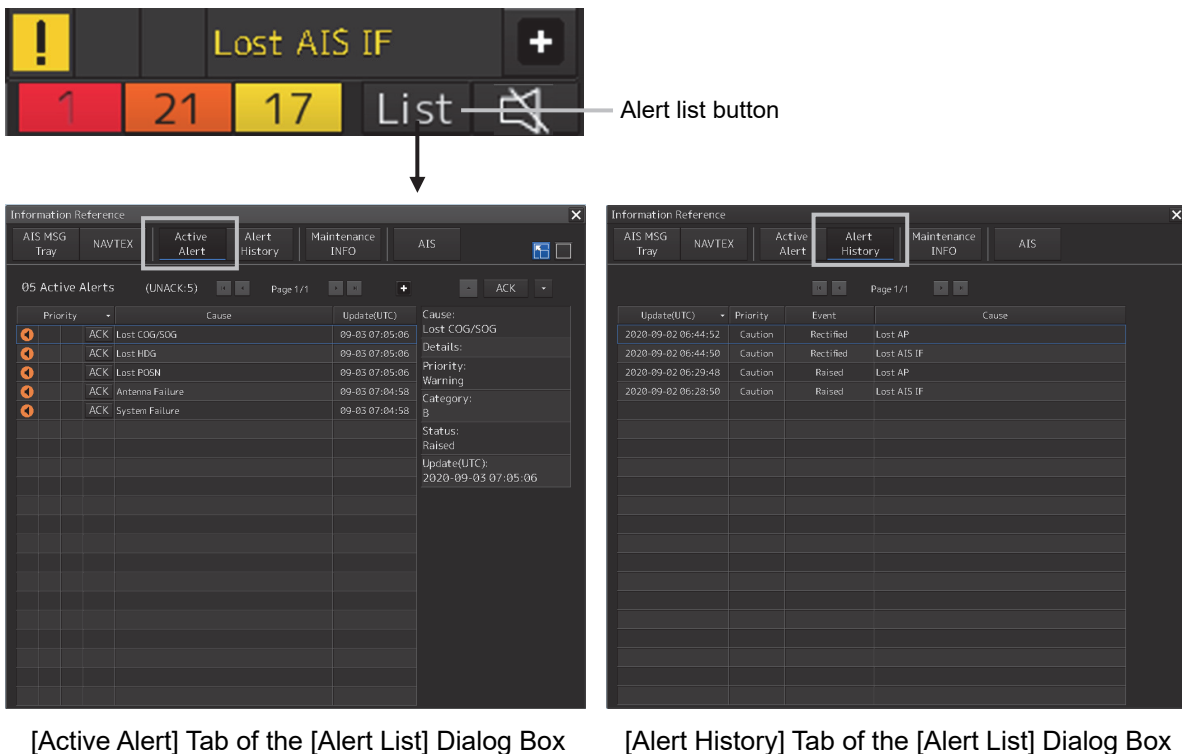

[[Active Alert] tab]

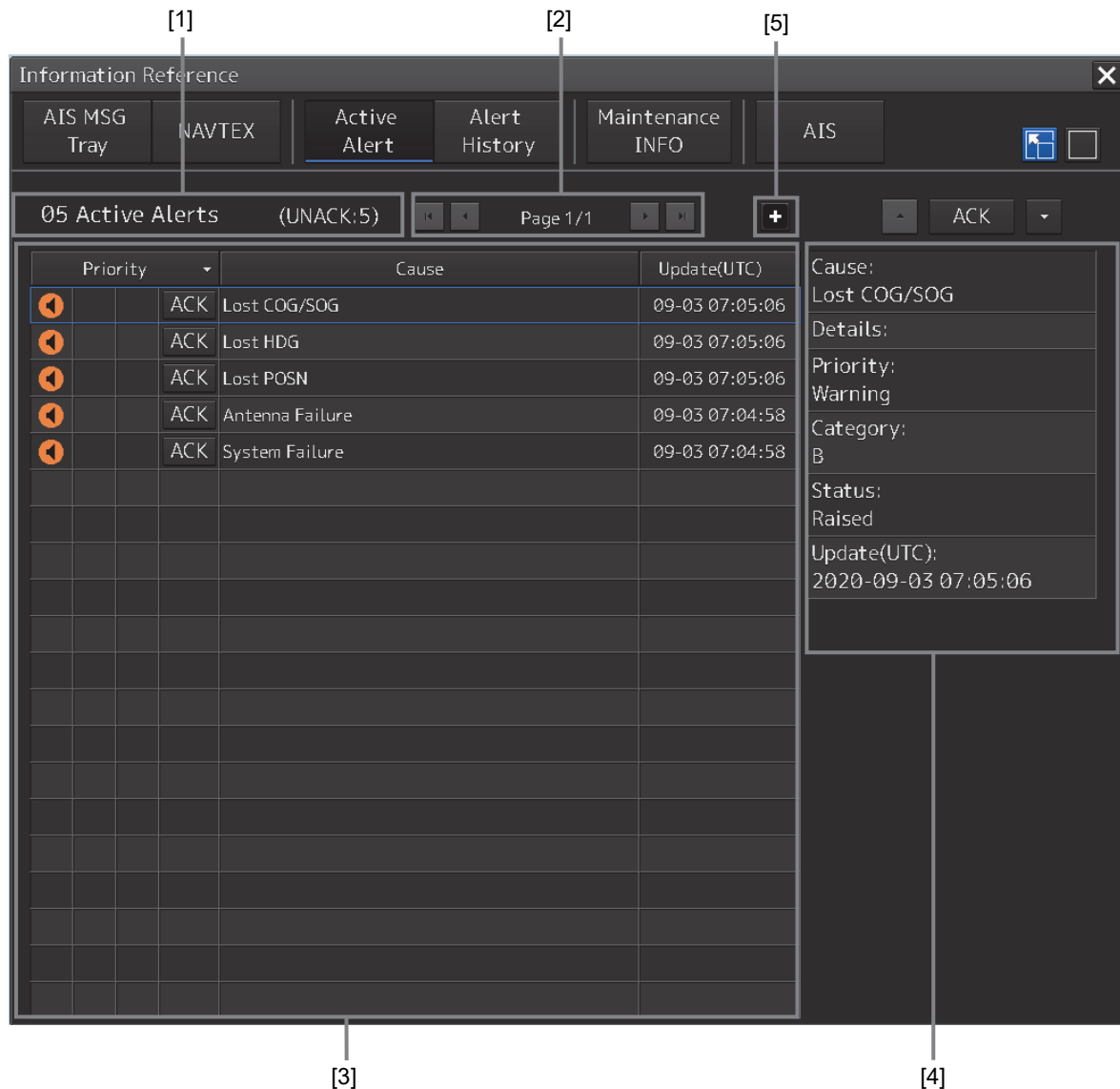

[1] Active alert information

The number of current alerts is displayed.



[2] Active page information

Up to 20 alert information items can be displayed in one page. Use this function to switch pages when the number of alert information items exceeds 20, requiring multiple pages.



[3] Active alert list

Priority			Cause	Update(UTC)
🔔		ACK	Lost COG/SOG	09-03 07:05:06
🔔		ACK	Lost HDG	09-03 07:05:06
🔔		ACK	Lost POSN	09-03 07:05:06
🔔		ACK	Antenna Failure	09-03 07:04:58
🔔		ACK	System Failure	09-03 07:04:58

- The alert of the highest priority is automatically selected. When an alert in the active alert list is clicked on, the alert is selected.

🔔		ACK	Lost COG/SOG	09-03 07:05:06
---	--	-----	--------------	----------------

- The details of the selected alert are displayed in "[4] Active alert details".
- When a new alert is generated during the screen display, the alert is added at the top of the list.
- By clicking on any of the items in the title line, active alerts can be sorted based on the item.

Priority			Cause	Update(UTC)
🔔		ACK	Lost COG/SOG	09-03 07:05:06
🔔		ACK	Lost HDG	09-03 07:05:06
🔔		ACK	Lost POSN	09-03 07:05:06

- When the [ACK] button is clicked on, the alert is acknowledged.

Priority			Cause
🔔		ACK	Lost COG/SOG
🔔		ACK	Lost HDG
🔔		ACK	Lost POSN

Memo

The [ACK] button is not displayed for the [Caution] alert since acknowledgement is not required.

[4] Details of active alert

Details of the alert that is currently selected are displayed.



Alert	Detailed information
Cause:	Displays the cause of the alert.
Details:	Displays the details of the cause of the alert.
Priority:	Displays the alert priority (identification of Alarm/Warning/Caution).
Category:	Displays the alert category.
Status	Displays the status of the alert (Raised/Silenced/ACKed/Transferred/UnACK-Rectified).
Updated	Displays the latest update time of the alert.

[Higher] button

When this button is clicked on, the details of the alert of the higher priority than the alert that is currently displayed appear.

[Lower] button

When this button is clicked on, the details of the alert of the lower priority than the alert that is currently displayed appear.

[ACK] button

When this button is clicked on, the alert that is currently selected is acknowledged.

[5] Aggregation of alert

When this button is clicked on, display of the aggregation of alert is switched to ON or OFF.



Aggregation: OFF (Default)



Aggregation: ON

- When aggregation is off, all alerts are displayed.

Priority	ACK	Cause	Update(UTC)	Cause:
▲		Crossing Safety Contour	09-09 05:28:59	Crossing Safety Contour
▲		Dumping Ground	09-09 05:30:29	Details: Check ahead on the DISP
▲		Spoil Ground	09-09 05:30:29	Priority: Alarm
▲		Caution Area	09-09 05:30:29	Category: A
▲		Restricted Area	09-09 05:30:29	Status: Raised
▲		Fairway	09-09 05:30:29	Update(UTC): 2020-09-09 05:28:59
▲		Traffic Roundabout	09-09 05:30:29	
▲		Recommended Traffic Lane	09-09 05:30:25	
▲		Traffic Separation Zone	09-09 05:30:22	
!		To Be Avoided	09-09 05:28:30	
!		AtcN	09-09 05:28:30	

- When aggregation is on, alerts are aggregated. Displays Header alerts only.

Priority	ACK	Cause	Update(UTC)	Cause:
▲		Crossing Safety Contour	09-09 05:28:59	Warning Area/Object
▲		Warning Area/Object	09-09 05:30:25	Details: Check ahead on the DISP
!		Caution Area/Object	09-09 05:28:30	Priority: Warning
				Category: A
				Status: Raised
				Update(UTC): 2020-09-09 05:30:25

- When Cause of Header alerts is clicked, display of Member alerts is switched to ON or OFF.

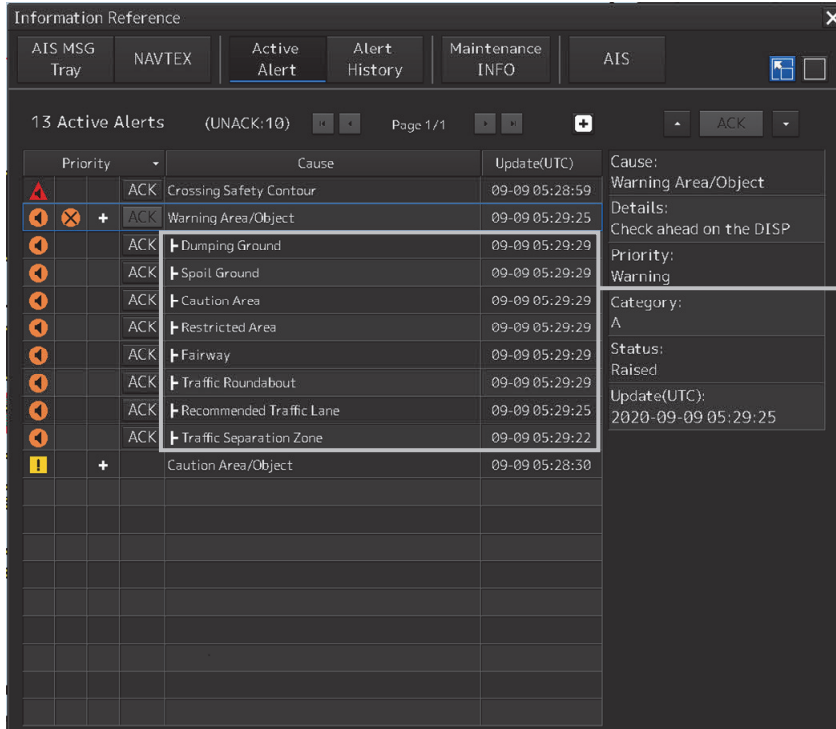

Member alerts

[Header alerts]

Alert of an aggregation, under which the associated member alerts are sorted. Header alerts are displayed with a + when the header alert is associated with a member alert. And header alerts are displayed with ✖ because header alerts are not allowed to acknowledge.

[Member alerts]

Alerts aggregated by aggregation source. Member alerts are displayed in a hierarchy.

Note

Alerts will not be aggregated if more than one member alert does not exist.

[[Alert History] tab]

Alerts that have been generated in the past are displayed.

Update(UTC)	Priority	Event	Cause
2020-09-02 06:44:52	Caution	Rectified	Lost AP
2020-09-02 06:44:50	Caution	Rectified	Lost AIS IF
2020-09-02 06:29:48	Caution	Raised	Lost AP
2020-09-02 06:28:50	Caution	Raised	Lost AIS IF

[1]

[2]

[1] Alert History List

- Up to 20 events of alerts are displayed per page.
- When an alert is no longer active, the alert is added to the top of the list.
- By clicking on any of the items in the title row, alert can be sorted based on the item.
- Alerts are added per event as follows.

2020-09-04 04:27:53	Warning	ACKed	Course difference
2020-09-04 04:27:15	Warning	Raised	Course difference

Event	Detailed information
Raised	Alert raised
Silenced	Alert silenced
ACKed	Alert acknowledged
Transferred	Alert responsibility transferred
UnACK-Rectified	Rectified alert was unacknowledged
Rectified	Alert rectified
Repeat	Alert sound was repeated
Removed	Alert removed This event occurs when equipment shuts down, returns to the task menu, removes the installation, or loses the alert function.
Call Nav	Alarm was transferred to BNWAS

Memo

The Alert History screen is displayed under the extended window only. A standard window is not available.

For details on the alert contents, refer to "Reference Guide - Appendix A Alert List" in the Owner's Manual.

[2] Export of Alert History List

When this button is clicked on, Alert History List can be output.

1 Click on the [Export] button.

[Export] dialog box appears.

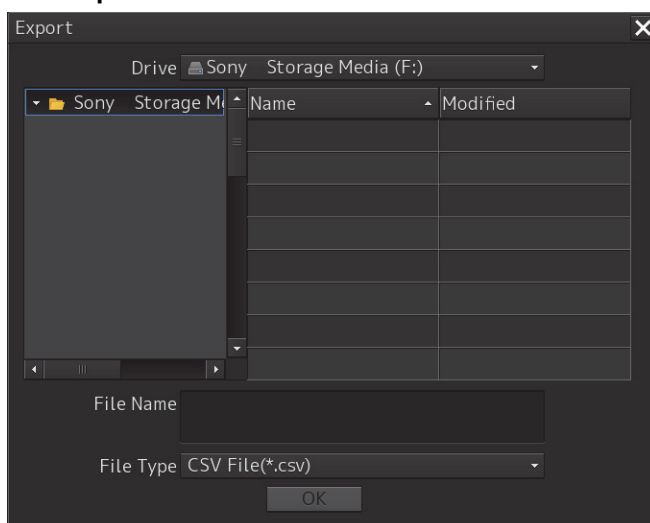
2 Select the storage destination of the Alert History List from the [Drive] combo box of the output destination.**3 Enter [File Name].****4 Click on the [OK] button.**

3.8 Switching the Day/Night Mode

The screen display color can be switched to any of five levels according to the brightness within the bridge.

Use the following procedure for switching.

- 1 Click on the Day/Night button on the right toolbar.





Adjustment buttons are displayed based on the brightness that is currently set.



Example: Day2 is set.

- 2 Adjust the brightness by using the  [Light] button and the  [Dark] button.

Whenever the  [Light] button is clicked on, the brightness increases by one level from the current level.

When the  [Dark] button is clicked on, the brightness decreases by one level from the current level.

 : Day 1

 : Day 2

 : Day 3

 : Dusk

 : Night



WARNING



Change of the color of the Day/Night button, particularly the use of the [Night] color, may interfere with the recognition of display information.

Memo

The colors and brightness of the buttons can be changed by setting [Settings] - [Color and Brilliance] in the menu. For the details, refer to "16.15 Setting Color and Brightness".

Relationship between the day/night mode and the screen/operation section brightness setting value

When the day/night mode is changed, the screen/operation section brightness is set to the following values.

	26-inch monitor NWZ-208	19-inch monitor NWZ-207	19-inch monitor NWZ-214
Screen brightness	Day1, Day2, Day3: 67/100 Dusk: 60/100 Night: 11/100	Day1, Day2, Day3: 42/100 Dusk: 20/100 Night: 4/100	Day1, Day2, Day3: 70/100 Dusk: 62/100 Night: 10/100
Operation unit brightness	Day1: Level4 Day2: Level3 Day3: Level2 Dusk, Night: Level1		

3.9 Adjusting the Brightness of the Screen and Operation Unit

3.9.1 Adjusting the Brightness of the Screen

The screen brightness can be adjusted within the range from 0 to 100.

- 1 Click on the [Display Brightness] button on the right toolbar.



The following screen brightness buttons are displayed.

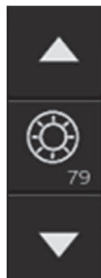

- 2 Adjust the brightness by using the  [Light] button and  [Dark] button. Whenever the [Light] button/[Dark] button is clicked on, the brightness changes by one level.

3.9.2 Adjusting the Brightness of the Operation Unit

The brightness of the operation section can be adjusted in 5 levels (0 to 4).

- 1 Click on the [Panel Brightness] (Brightness of the operation unit) on the Right Tool Bar.



The following operation unit brightness buttons are displayed.



- 2 Adjust the brightness by using the  [Light] button and  [Dark] button.

Whenever the [Light] button/[Dark] button is clicked on, the brightness changes by one level.

3.9.3 [Display Brightness] dialog box

If the [MULTI] dial is operated while [Display Brightness] function is selected as the [MULTI] dial assignment function, the [Display Brightness] dialog is displayed.

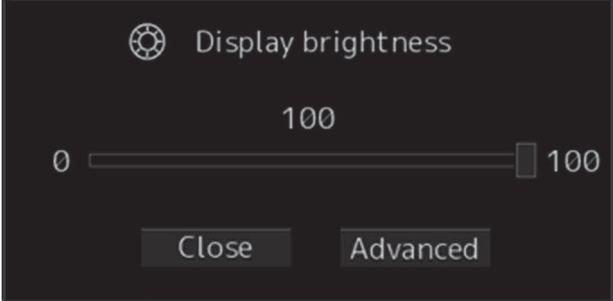

It is possible to adjust the brightness of the display section by rotating the [MULTI] dial.

In order to set an offset value so that when set to the same value as the screen brightness of other equipment, the light emitted becomes the same as in other equipment, click the [Advanced] button and

adjust the offset using the  buttons displayed for setting the [Offset].

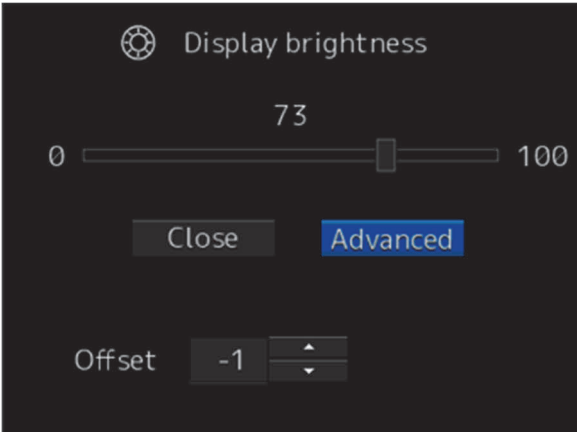

3.10 Mouseover Display

When the mouse cursor is hovered over an object on the screen, the information on the object is displayed on a popup window near the cursor.

When objects overlap, the following priority is applied and information on the object of the higher priority is displayed.

<u>Object</u>	<u>Priority</u>	
• AIS target	High	
• Tracking target		
• NAVTEX (symbol)		
• Event mark		
• Information mark		
• Tidal stream mark		
• User chart (symbol)		
• Buoy object		
• Light object		
• NAVTEX (line)		
• Clearing Line		
• User chart (line)		
• EBL1, EBL2		
• VRM1, VRM2		
• Parallel index lines 1 to 8		
• Intersecting point fixed EBL/VRM		
• AZ1, AZ2		
• AIS filter		
• Dragging anchor monitoring		
• WPT		
• NAVTEX (area)		
• Highlight (Highlighted display)		
• User chart (area)		Low

Memo

Refer to the following section for each object.

- AIS target/tracking target
“5.1 Displaying Symbols”
- NAVTEX (symbol/line/area)
“2.3.2.3 NAVTEX”
- Event mark
“6.12 Marking the Position of Own Ship with an Event Mark”
- Information mark/tidal stream mark/Clearing Line/Highlight (highlighted display)
“12.5.8 Creating Mariner's Mark/Line drawing objects (ECDIS screen only) ”
- User chart (symbol)
“12.5.1 Creating a symbol object (Symbol) ”
- EBL1/EBL2/VRM1/VRM2
“4.5 Using the Electronic Bearing Line (EBL) and Variable Range Marker (VRM)
- Parallel index lines 1 to 8
“4.6 Using Parallel Index Lines (PI) ”
- AZ1 and AZ2
“15.2 New Target Alarm Generation Conditions”
- AIS filter
“3.14.5 AIS filter”
- Dragging anchor monitoring
“9.2 Starting and Ending Dragging Anchor Monitoring”

3.10.1 Condition and timing of mouseover display

3.10.1.1 Starting mouseover display

Mouseover display is performed under the following condition and timing.

Condition	The cursor is in AUTO mode and Mouse Over Information is ON in Tooltips/Infotips of View-Options.
Timing	The cursor stops for 500ms.

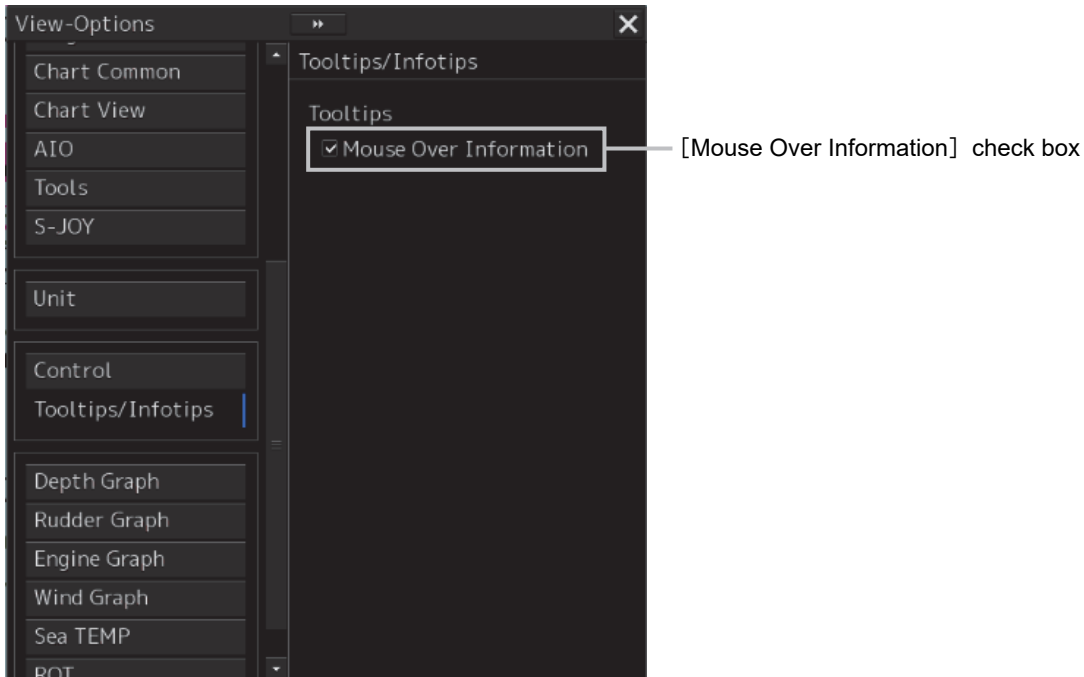

When [View] – [Options]-[Tooltips/Infotips] is selected on the menu, the [Mouse Over Information] check box is displayed. By default, the check box is turned ON.

When the motion mode of the chart is a relative motion display (RM) mode, the fixed object such as land moves.

In this case, mouseover display is not performed simply by hovering the cursor over the object.

By moving the cursor once and hovering the cursor over the object again, mouseover display can be performed.

For the details of the motion mode, refer to “6.6.1 Setting a motion mode”.

3.10.1.2 Terminating mouseover display

Mouseover display terminates when the cursor is moved based on a certain distance or the mouse button is clicked.

3.10.2 How to read mouseover display

3.10.2.1 Example of mouseover display

When mouseover is performed on a user chart (symbol), the following popup window is displayed.

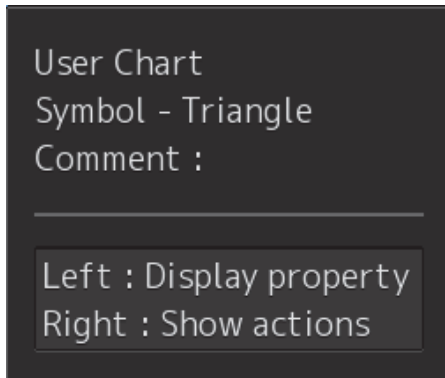

The width and height of the popup window changes according to the number of characters that are displayed.

3.10.2.2 Mouseover display of an AIS target/tracking target

The following information is displayed through mouseover display of an AIS target/tracking target.

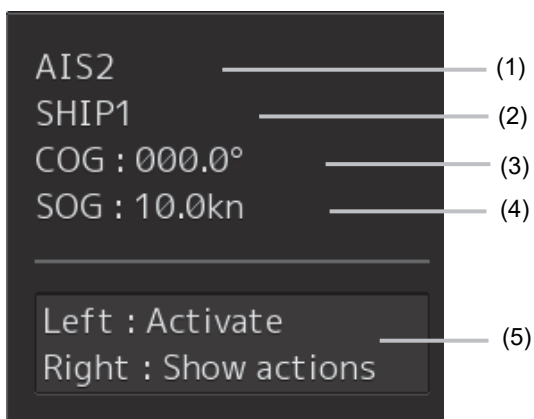

[1] Target ID

A target ID is displayed in the following notation.

AIS:

AIS + target ID

Tracking target (RADAR screen):

TT + target ID

Tracking target (ECDIS screen):

“T1-“+ target ID or “T2-“+ target ID

[2] Ship's name

Displays the name of the target ship.

[3] COG or CTW

Displays the course over the ground (COG) or the course through the water (CTW).

[4] SOG or STW

Displays the speed over the ground (SOG) or the speed through the water (STW).

[5] Operation guide display area

The operations that can be performed for this object are displayed.

In this example, [Left : Activate] indicates that if it is clicked on, the AIS target can be activated. [Right : Show actions] (right: displays the possible operations) indicates that if it is clicked on, a context menu is displayed.

3.10.2.3 Mouseover display of a buoy/light

In mouseover display of a buoy/light, the items containing data among the information that is indicated below are displayed in the sequence indicated below.

The items that are displayed are the same between Buoy and Light other than the title.

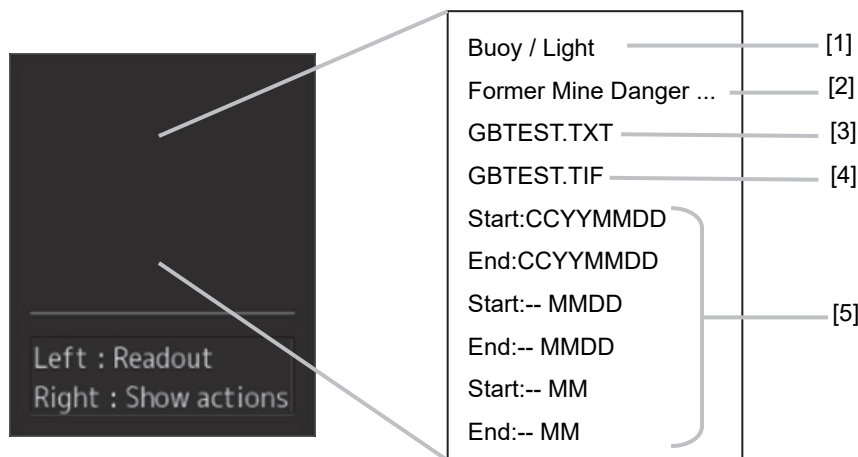

[1] Title (Buoy or Light)

[2] Object information

When the information overflows one line, an ellipsis is shown at the end.

[3] Text information

Displays the text file name of the object.

[4] Image information

Displays the image file name of the object.

[5] Start/end for specifying the duration

Displays the start and end dates of the specified duration when an object display duration is specified.

The display formats are as follows:

[In the case of CCYYMMDD]

CCYY: Year MM: Month DD: Day

<Display example>

Start:CCYYMMDD

End:CCYYMMDD

[In the case of --MMDD]

MM: Month DD: Day every year

<Display example>

Start:-- MMDD

End:-- MMDD

[In the case of --MM]

MM: Month every year

<Display example>

Start:-- MM

End:-- MM

3.11 MOB (Man Over Board)

When a person falls overboard, this monitoring function prevents loss of sight of the position of the person overboard.

The MOB use procedure is as follows.

- 1 Click on the [MOB] button on the right toolbar.

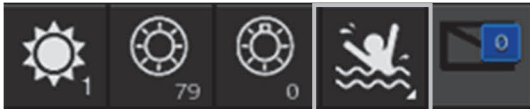

The [Marker] dialog box appears and the MOB marker is displayed on the own ship's position when the button is clicked on.



[Marker] dialog Box

Memo

The [Marker] dialog box appears by clicking [Tools] - [MOB] on the menu

2 Monitor with the screen and the [Marker] dialog box.

The position relationship between the own ship that is moving and the MOB marker is displayed as follows.

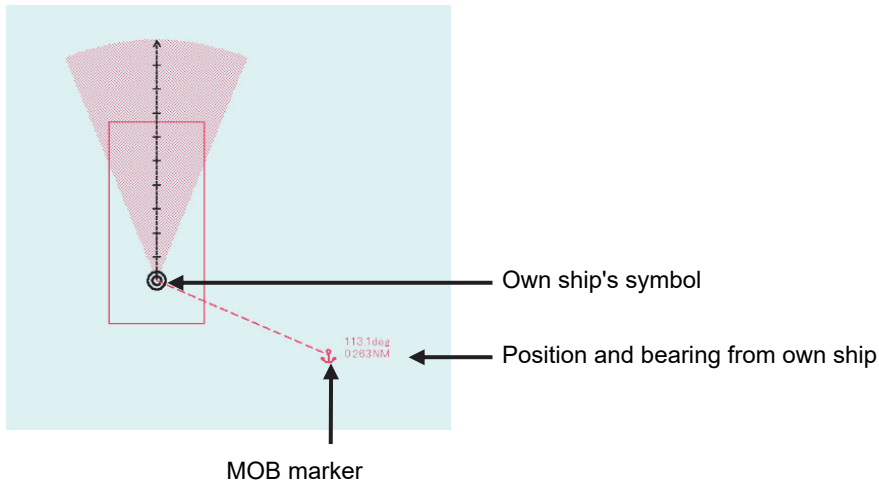

See below for how to reference the [Marker] dialog box.

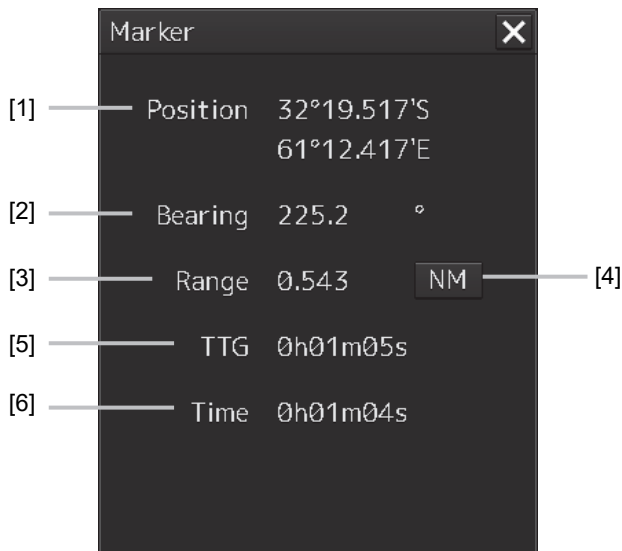

[1] [Position]

Displays the coordinate of the MOB marker.

[2] [Bearing]

Displays the bearing from the own ship to the MOB marker.

[3] [Range]

Displays the range from the own ship to the MOB marker.

[4] NM/Km/sm switching button

Whenever this button is clicked on, the unit of [Range] is switched to NM, km or sm.

Memo

NM denotes nautical mile, sm denotes statute mile, and km denotes kilometer.

[5] [TTG]

Displays the time to reach the MOB marker from the ship speed.

[6] [Time]

Displays the time elapsed after clicking on the [MOB] button.

To exit from MOB

- 1 Click the [X] button in the [Marker] dialog box.**



A confirmation dialog box appears.

- 2 Click on the [OK] button.**

The [Marker] dialog is closed.

The MOB marker is cleared.

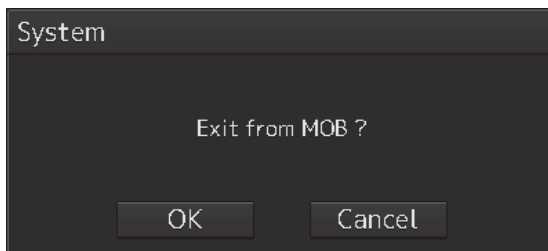

3.12 Setting up the Timer

When [Timer] is selected in the Tools menu, the [Timer] dialog is displayed. In this dialog, the time to generate an alarm can be set up.

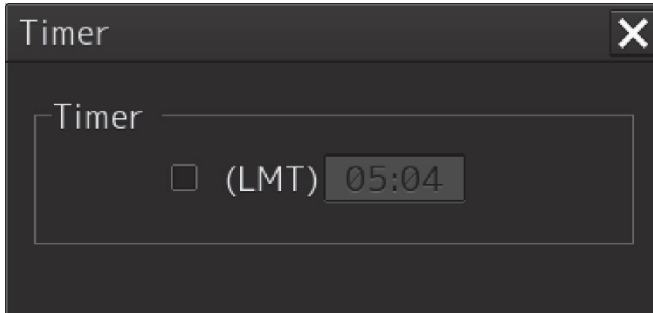

3.12.1 Setting up the timer

To turn on the timer, select the [(LMT)] check box.
To turn off the timer, clear the [(LMT)] check box.

3.12.2 Setting up the time

When you click on the [Timer (LMT)] input box, the numeric value input keyboard appears. Specify the time at which to generate an alarm in a range between 00:00 and 23:59. For the use of the numeric value input keyboard, refer to "3.17.2 Name and function of each section of the keyboard".

3.13 Electronic Bearing Line (EBL) and Variable Range Marker (VRM)

3.13.1 Electronic Bearing Line (EBL) and Variable range marker (VRM)

The electronic bearing line (EBL) and the variable range marker (VRM) are the essential tools for measuring bearings and ranges.

This equipment is equipped with two sets each for EBL (EBL1/EBL2) and VRM (VRM1/VRM2).

An intersecting point mark is displayed at the intersecting point between EBL and VRM.

By setting an intersecting point at any location, the bearing and range from the own ship's position to the location can be measured.

Two sets of EBL and VRM can be operated independently.

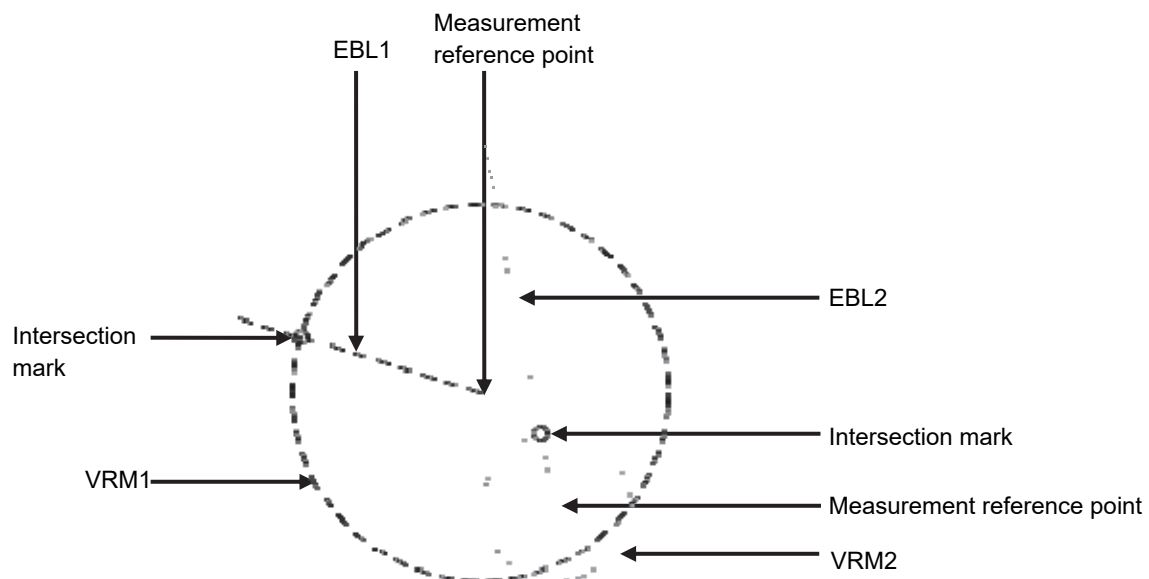

The first EBL and VRM are displayed in long dashed line and the second EBL and VRM are displayed in short dashed line.

Memo

The line colors can be set on the dialog that is displayed by selecting [Settings] - [Color and Brightness] on the menu.

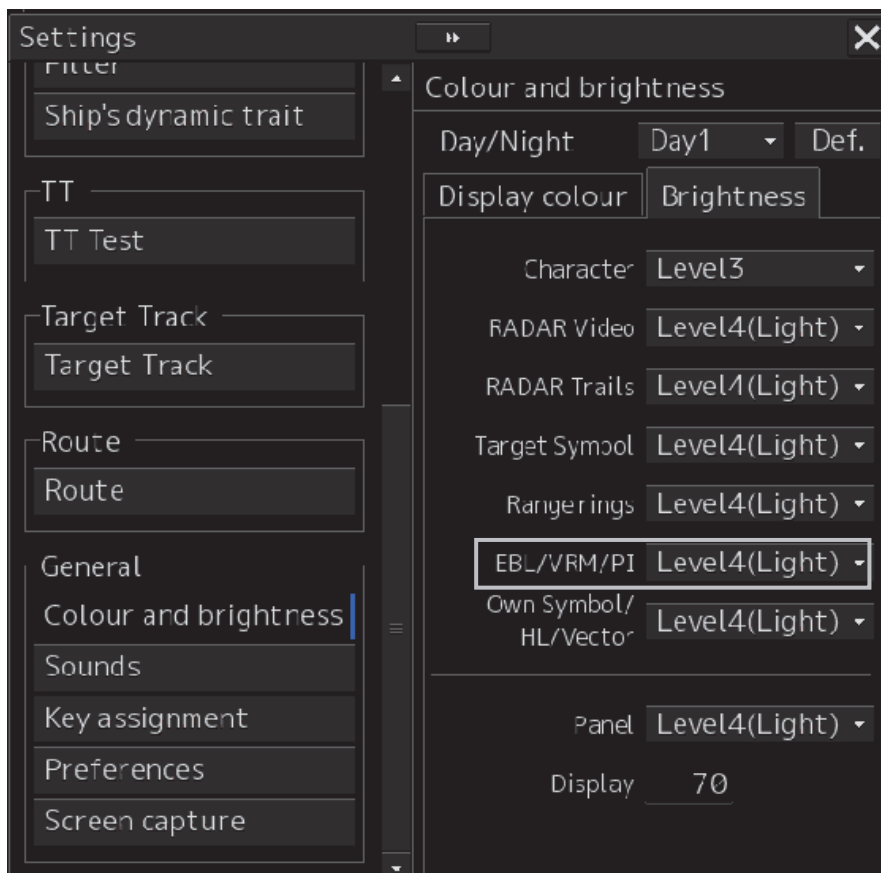

3.13.2 Displaying the EBL and VRM buttons

Use the EBL/VRM button for creation and setting of EBL/VRM and bearing/range of EBL/VRM.

[Displaying from the menu]

Use the [EBL/VRM readout] dialog.

Use the following method to display the dialog.

1 Click on the [Menu] button on the left toolbar.

A menu is displayed.

2 Click on [Tools] - [EBL/VRM] on the menu.

The [EBL/VRM readout] dialog is displayed.

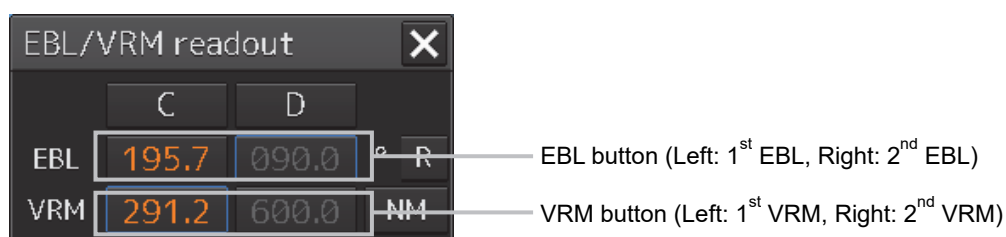

[Closing the [EBL/VRM readout] dialog]

Click on the [X] button.

Memo

The display mode of EBL/VRM that is displayed on the dialog by selecting [View] - [Options] - [Tools] on the menu can be set to display/hidden.

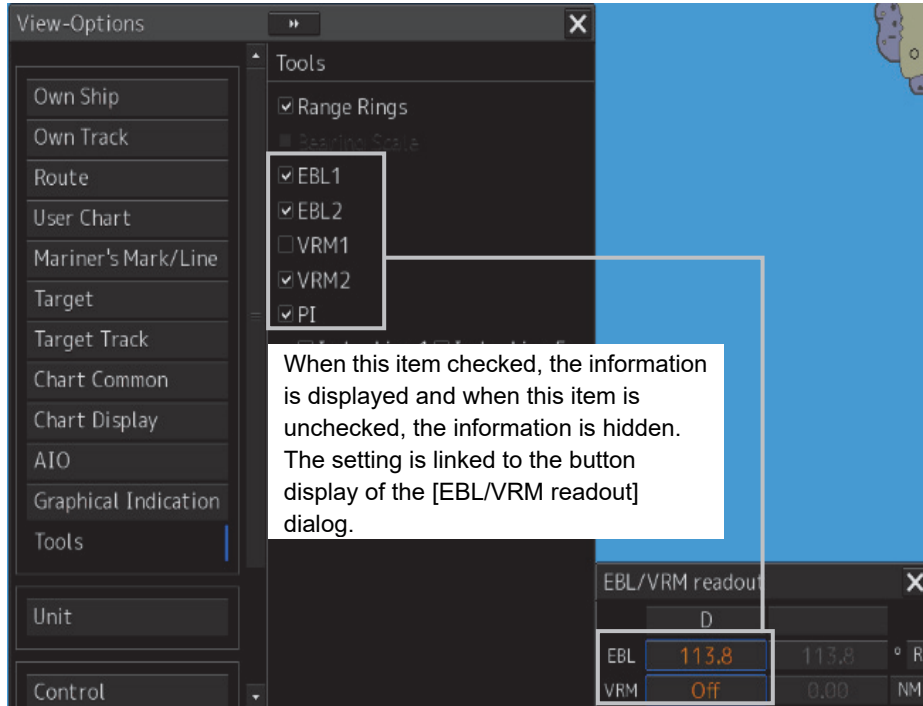

[Displaying by using the [EBL] and [VRM] dials]

By operating the [EBL] and [VRM] dials on the keyboard operation unit, the [EBL/VRM readout] dialog can be displayed.

3.13.3 Basic manipulation of EBL/VRM

3.13.3.1 Switching the control right of EBL/VRM

This equipment is equipped with two sets of EBL (EBL1/EBL2) and VRM (VRM1/VRM2).

To use EBL/VRM, the EBL/VRM to be used must be enabled.

To enable EBL/VRM, click on the EBL/VRM button.

The status of EBL/VRM can be checked by using the EBL/VRM button.

[Button in [OFF] state]

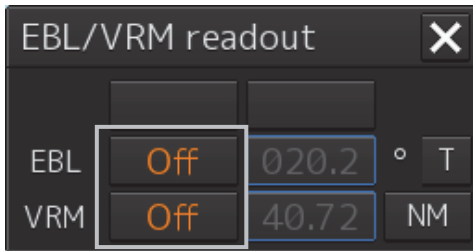

EBL/VRM is disabled and is not displayed on the screen

When the button is clicked on, EBL/VRM is displayed and the manipulation is enabled.

[Numeric value displayed on the button]

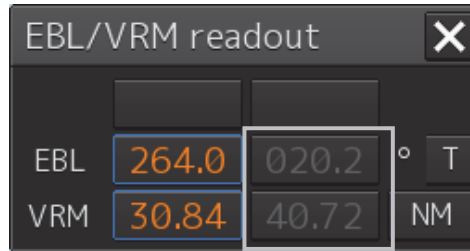

- When the button is enclosed by a blue frame, EBL/VRM is displayed and the manipulation is enabled (with control right).
When this button is clicked on, the blue frame is cleared and the manipulation is disabled (without control right).
- When the button is not enclosed by a blue frame, although EBL/VRM is displayed on the screen, the manipulation is disabled (without control right).
When the button is clicked on, the display is changed to [OFF].
When the button is double-clicked, the button is enclosed by a blue frame and the manipulation is enabled (with control right).

3.13.3.2 Setting up the measurement starting points

The measurement starting points of the EBL/VRM in operation can be changed. Set up the measurement starting points as usage.

1 Enable the manipulation of EBL/VRM by clicking on the EBL/VRM button.

The display of the clicked button changes from [OFF] to the bearing presentation of the measurement starting point.

2 Click on the Measurement Starting Point button of the EBL/VRM in the operational state.

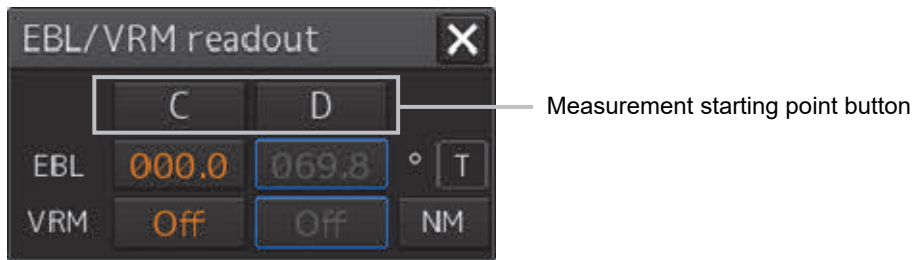

Each time this button is clicked on, the measurement starting point switches in the order of blank field → [C] → [D] → blank field and so on.

Blank field (CCRP): Sets the measurement starting point to the own ship position (CCRP).

C (Carried): Fixes the measurement starting point on the screen.

D (Dropped): Fixes the measurement starting point at longitude and latitude point.

Memo

In the case of [D], it is necessary to connect a navigation unit.

3.13.3.3 Setting the EBL bearing to True/Relative display

The EBL bearing True/Relative display can be changed by using the True/Relative button of EBL of the Navigation Tools (measuring tools).

Setting the EBL numeric value display mode

1 Click on the true/relative button of EBL bearing.

Each time the button is clicked on, display switches between [T] → [R] → [T] in this order.

[T]: Displays EBL bearing in true bearing.

[R]: Displays EBL bearing in relative bearing.

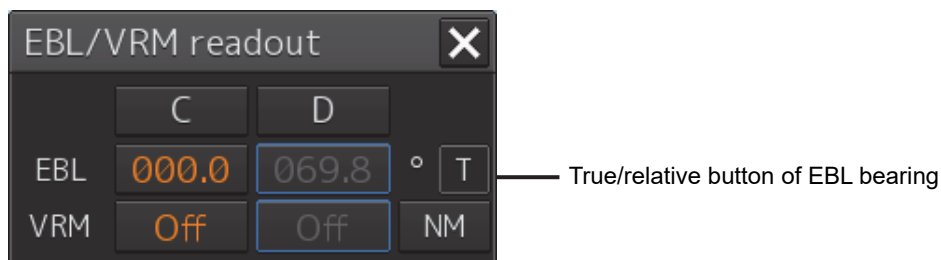

Memo

The true/relative presentation of EBL bearing is common between EBL1 and EBL2.

3.13.3.4 Setting up the range unit of VRM

1 Click on the VRM Range Unit button.

Each time the button is clicked on, display switches in the order of [NM] → [sm] → [km] → [NM]

[NM]: Displays the range in the unit of NM.

[sm]: Displays the range in the unit of sm.

[km]: Displays the range in the unit of km.

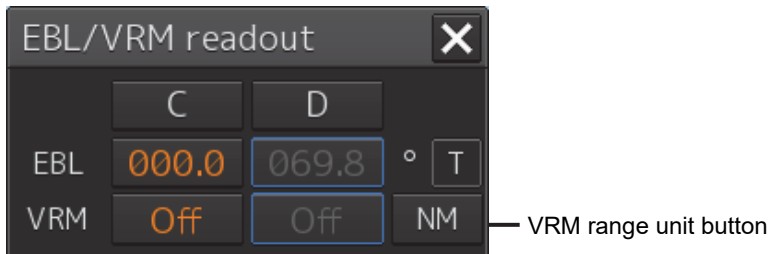

Memo

The VRM range unit is common between VRM1 and VRM2.

NM denotes nautical mile, sm denotes statute mile, and km denotes kilometer.

3.13.3.5 Operating the intersecting point between EBL and VRM

1 Place the cursor on the intersection mark (O) and click the mouse button.

EBL and VRM are set to a movable state.

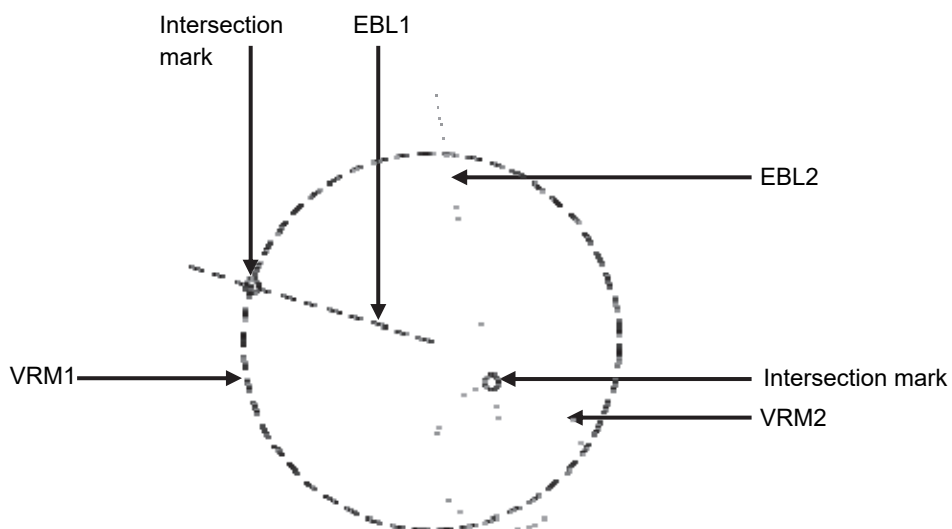

2 Move the cursor to the required target or the coordinate.

EBL and VRM move together with the cursor.

3 Click on the mouse button.

The EBL and VRM are fixed.

3.14 Cursor AUTO Mode

The cursor AUTO mode (referred to as AUTO mode henceforth) is a function that automatically executes the function (operation) that is assigned to the object when the object under the cursor is clicked on.

The AUTO mode is effective for the following objects.

Object	Section that describes the function (operation) to be executed
No object (when the button is clicked on the position without a valid object under the AUTO mode on a chart)	3.14.1 No object
AIS	3.14.2 AIS
TT	3.14.3 TT
Acquisition/Activation Zone (AZ)	3.14.4 (AZ) Acquisition/Activation Zone
AIS filter	3.14.5 AIS filter
User chart	3.14.6 User chartUser chart
Mariner's Mark/Line	3.14.7 Mariner's Mark/Line
Manual update	3.14.8 Manual updating
Buoy object	3.14.9 Buoy object
Light object	3.14.10 Light object
EBL	3.14.11 EBL
VRM	3.14.12 VRM
EBL/VRM intersecting point	3.14.13 EBL/VRM intersecting point
Node Fixed EBL/VRM	3.14.14 Node Fixed EBL/VRM
PI	3.14.15 PII, 4.6 Using Parallel Index Lines (PI)
WPT of monitored route	3.14.16 WPT of Monitored Route
Monitoring dragging anchor	3.14.17 Monitoring dragging anchor
Route planning	3.14.18 Planned route

Note

When using ECDIS in AUTO mode, if there is no object under the cursor, the chart position at the cursor will move to the center of the screen according to "3.13.1". When the ship is under vibration and rough sea conditions, the center of the chart will be moved to an unintended position by inadvertent left-click operation. Confirm the cursor type on the object is changed to other types before left-click operation for AUTO mode operation.

3.14.1 No object

When the button is clicked on the position on the chart without a valid object under the AUTO mode, the following operation is performed.

Executes off-centering (sets the clicked position as the center of the screen).

3.14.2 AIS

[Sleeping AIS target target]

When a sleeping AIS target is clicked on, the AIS target is activated.

[Activated AIS target]

When an Activated AIS target is clicked on, the AIS target value is displayed.

[Numeric displayed AIS target]

When the numeric displayed AIS target is clicked on, the AIS target value display is cancelled.

[AIS-SAR aircraft normal target]

When an AIS-SAR aircraft in the normal state is clicked on, the AIS-SAR aircraft is selected and the AIS-SAR aircraft value is displayed.

[Numeric displayed AIS-SAR aircraft]

When a numeric displayed AIS-SAR aircraft is clicked on, the sleeping target of the AIS-SAR aircraft is displayed and the AIS-SAR aircraft value display is cancelled.

[Sleeping AIS-SAR vessel target]

The same operation as the normal sleeping AIS target is performed.

[Activated AIS-SAR vessel target]

The same operation as the normal activated AIS target is performed.

[Numeric displayed AIS-SAR vessel target]

The same operation as the normal numeric displayed AIS target is performed.

[Activated AIS-SART]

The same operation as the normal activated AIS target is performed.

[Numeric displayed AIS-SART target]

The same operation as the normal numeric displayed AIS target is performed.

[AtoN normal target]

When AtoN target in a normal state is clicked on, the AtoN normal target is selected and the numeric value of AtoN is displayed.

[Numeric displayed AtoN target]

When a numeric displayed AtoN target is clicked on, the AtoN normal target is deselected and the numeric value of AtoN normal target is cancelled.

[AIS-shore base station normal target]

When an AIS-shore base station target in a normal state is clicked on, the AIS-shore base station is selected and the numeric value of AIS-shore base station is displayed.

[Numeric displayed AIS-shore base station normal target]

When an AIS-shore base station in a normal state is clicked on, the AIS-shore base station is deselected and the numeric value of AIS-shore base station is cancelled.

[Activated AIS-MOB]

The same operation as the normal activated AIS target is performed.

[Numeric displayed AIS- MOB target]

The same operation as the normal numeric displayed AIS target is performed.

[Activated EPIRB-AIS]

The same operation as the normal activated AIS target is performed.

[Numeric displayed EPIRB-AIS target]

The same operation as the normal numeric displayed AIS target is performed.

3.14.3 TT

[Tracked target]

When a tracked target is clicked on, a numeric value is displayed.

[Numeric displayed tracked target]

When a numeric displayed tracked target is clicked on, the numeric value display of TT is cancelled.

3.14.4 (AZ) Acquisition/Activation Zone

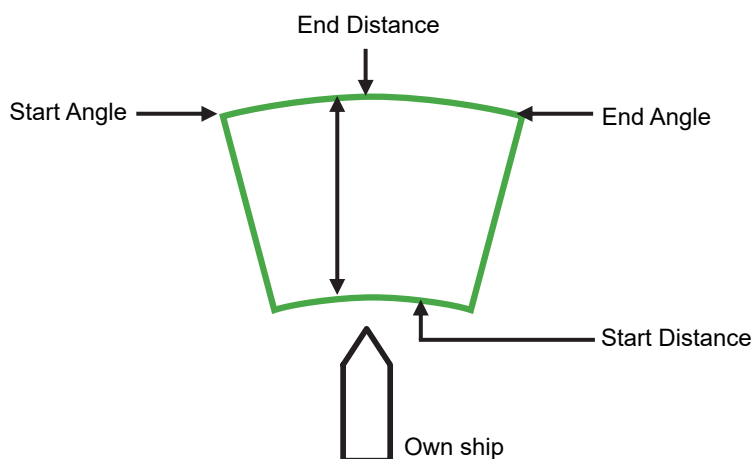

[Start Angle]

When Start Angle is clicked on, the cursor is set to the Start Angle/End Angle change mode.

[End Angle]

When End Angle is clicked on, the cursor is set to the End Angle change mode.

[Start Distance]

When Start Distance is clicked on, the cursor is set to the Start Distance/End Distance change mode.

[End Distance]

When End Distance is clicked on, the cursor is set to the End Distance change mode.

Memo

When Acquisition/Activation Zone is not displayed on the radar screen, AIS automatic activation is disabled. If automatic AIS sleeping targets activation is necessary, please set up the acquisition/activation zone.

3.14.5 AIS filter

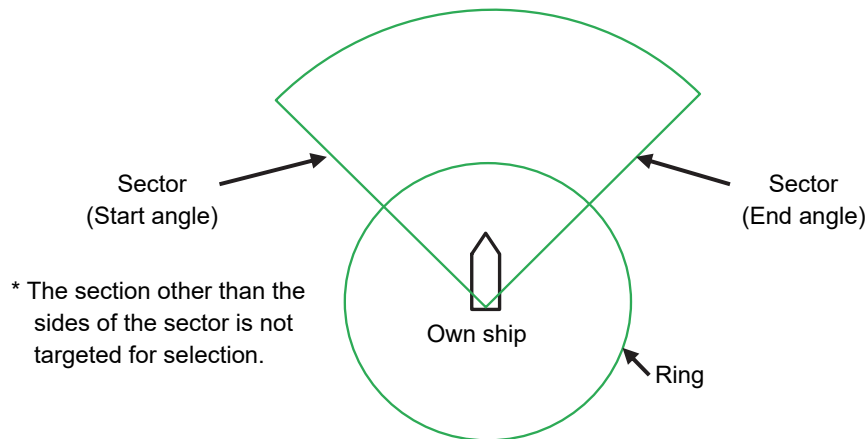

[Sector (start angle)]

When Sector (start angle) is clicked on, the cursor is set to the Sector (start/end angle) change mode.

[Sector (end angle)]

When Sector (end angle) is clicked on, the cursor is set to the Sector (end angle) change mode.

[Ring]

When Ring is clicked on, the cursor is set to the Ring change mode.

Memo

The values of Sector (start angle) and Sector (end angle) indicate relative bearings based on the ship's heading as the standard.

3.14.6 User chart

The operation of an object in the unselected state is different from that of an object in the selected state.

3.14.6.1 Non-selected object

When an object created on the user chart is clicked on, the object is selected and the property screen of the object is displayed.

3.14.6.2 Selected object

The operation varies according to the object.

(1) Symbol

When the selected symbol is clicked on, a symbol move mode is set.

When the right button is clicked, the symbol move mode is cancelled.

(2) Simple line

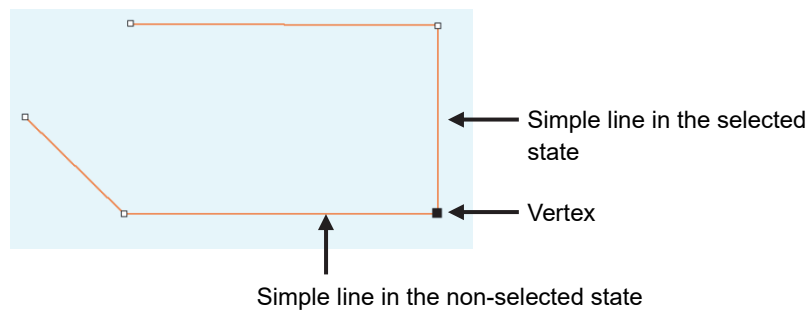

[Selecting vertex]

<Non-selected state>

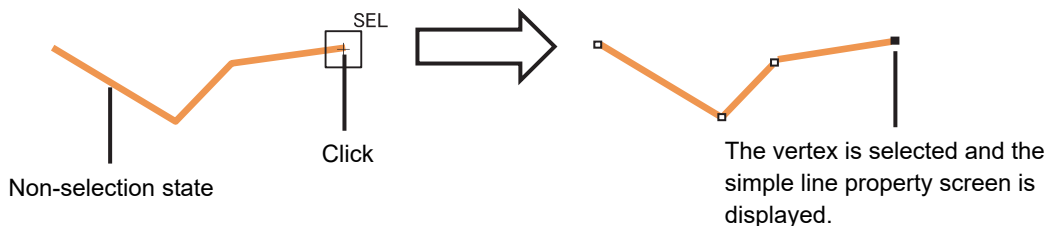

<Selected state>

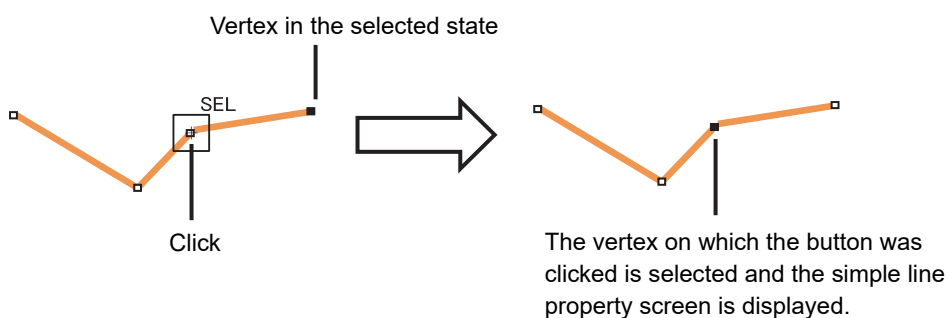

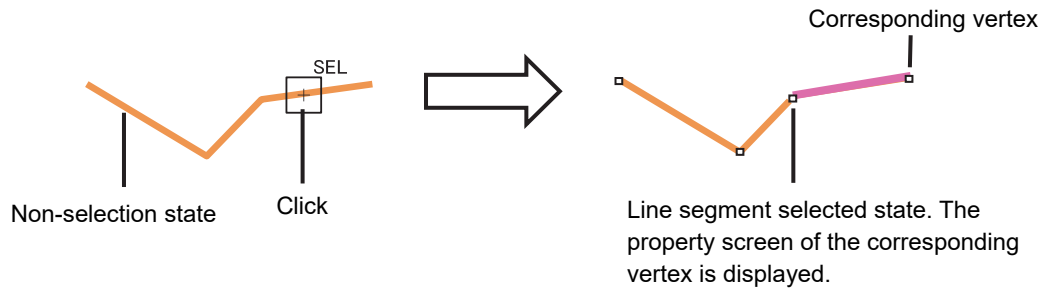
[Selecting a line segment]**[Moving a vertex]**

When the middle point of simple line in the selected state is clicked on, vertex move mode of simple line is set.

[Inserting a vertex]

When a line segment of simple line in the selected state is clicked on, vertex insertion mode of simple line is set.

Memo

A vertex can also be inserted by using [Insert Vertex] on the context menu that is displayed by clicking the right button on the simple line in the selected state.

When the insertion point is the starting point or the ending point, a vertex can be inserted with [Add Vertex].

[Cancelling operation]

By clicking the right button, the vertex addition, move, or insertion mode can be cancelled.

(3) Line-Circle**[Moving Line-Circle]**

When the circumference of the line-circle in the selected state is clicked on, move mode of line-circle is set.

[Changing a radius]

When a square of four corners of the line-circle in the selected state is clicked on, radius set mode of line-circle is set.

[Cancelling operation]

By clicking the right button, the line-circle move or radius change mode can be cancelled.

(4) Line-Ellipse**[Moving line-ellipse]**

When the circumference of the line-ellipse in the selected state is clicked on, move mode of line-ellipse is set.

[Changing vertical/horizontal width]

When a square of four corners of the line-ellipse in the selected state is clicked on, a vertical/horizontal width change of line-ellipse mode is set.

[Cancelling operation]

By clicking the right button, the line-ellipse move or vertical/horizontal width change mode can be cancelled.

(5) Arc

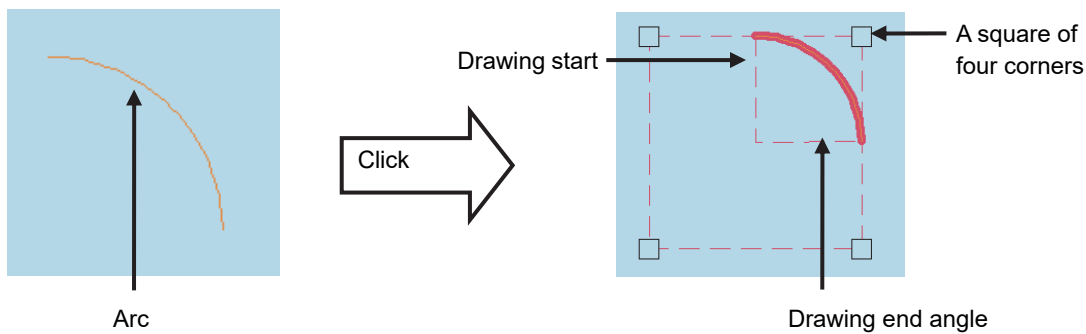

[Moving an arc]

When the arc in the selected state is clicked on, move mode of arc is set.

[Changing a radius]

When a square of four corners of the arc in the selected state is clicked on, radius set mode of arc is set.

[Drawing start angle]

When a drawing start angle of the arc in the selected state is clicked on, drawing start angle set mode of arc is set.

[Drawing end angle]

When a drawing end angle of the arc in the selected state is clicked on, drawing end angle set mode of arc is set.

[Cancelling operation]

By clicking the right button, the arc move, radius change, drawing start angle change, or drawing end angle change mode can be cancelled.

(6) Polygon

[Moving a vertex]

When a vertex of the polygon in the selected state is clicked on, vertex move mode of polygon is set.

[Inserting a vertex]

When a line segment of the polygon in the selected state is clicked on, vertex insertion mode of polygon is set.

Memo

A vertex can also be inserted by using [Insert vertex] on the context menu that is displayed by clicking the right button on the selected polygon.

[Moving a polygon]

When the inside of the polygon in the selected state is clicked on, move mode of polygon is set.

[Cancelling operation]

By clicking the right button, the vertex move, insertion, or polygon move mode can be cancelled.

(7) Area-Circle

[Moving Area-Circle]

When the circumference of the area-circle in the selected state is clicked on, an area-circle move mode is set.

[Changing a radius]

When a square formed by four corners of area-circle in the selected state is clicked on, an area-circle radius setting mode is set.

[Cancelling operation]

By clicking the right button, the area-circle move or radius change mode can be cancelled.

(8) Area-Ellipse

[Moving area-ellipse]

When the circumference or inside of the area-ellipse in the selected state is clicked on, an area-ellipse move mode is set.

[Changing a radius]

When a square formed by four corners of area-ellipse in the selected state is clicked on, an area-ellipse radius setting mode is set.

[Cancelling operation]

By clicking the right button, the area-ellipse move or radius change mode can be cancelled.

(9) Sector

[Moving a sector]

When a circumference or inside of the sector in the selected state is clicked on, a fan move mode is set.

[Changing a radius]

When a square formed by four corners of the sector in the selected state is clicked on, a sector radius setting mode is set.

[Drawing start angle]

When a drawing start angle of the sector in the selected state is clicked on, a sector drawing start angle setting mode is set.

[Drawing end angle]

When a sector drawing end angle in the selected state is clicked on, a sector drawing end angle setting mode is set.

[Cancelling operation]

By clicking on the right button, the sector move, radius change, drawing start angle change or drawing end angle change mode can be cancelled.

(10) Text

[Moving text]

When the text object in the selected state is clicked on, move mode of the text object is set.

[Cancelling operation]

By clicking the right button, the text move mode can be cancelled.

(11) Arrow

[Moving an arrow]

When a line segment of the arrow in the selected state is clicked on, move mode of the arrow is set.

[Moving a start point]

When a start point of the arrow in the selected state is clicked on, start point move mode of the arrow is set.

[Moving an end point]

When an end point of the arrow in the selected state is clicked on, end point move mode of the arrow is set.

[Cancelling operation]

By clicking the right button, the arrow move or start point/end point move mode can be cancelled.

3.14.7 Mariner's Mark/Line

3.14.7.1 Object in the non-selected state

When the object that is created by using Mariner's Mark/Line is clicked on, the object is selected and the property screen of the object is displayed.

3.14.7.2 Object in selected state

The operation varies according to the object.

(1) Event mark in the selected state

When an event mark is clicked on, the selected state of the event mark is cleared.

(2) Information Mark

When Information Mark in the selected state is clicked on, move mode of Information Mark is set. By clicking the right button, the Information Mark move mode can be cancelled.

(3) Tidal Stream

When Tidal Stream in the selected state is clicked on, move mode of Tidal Stream is set. By clicking the right button, the Tidal Stream move mode can be cancelled.

(4) Clearing Line

[Moving Clearing Line]

When a line segment of Clearing Line in the selected state is clicked on, move mode of Clearing Line is set.

[Moving a start point]

When a start point of Clearing Line in the selected state is clicked on, start point move mode of Clearing Line is set.

[Moving an end point]

When an end point of Clearing Line in the selected state is clicked on, end point move mode of Clearing Line is set.

[Cancelling operation]

By clicking the right button, the Clearing Line move or start point/end point move mode can be cancelled.

(5) Highlight

[Moving a vertex]

When a vertex of a highlight in the selected state is clicked on, vertex move mode of highlight is set.

[Inserting a vertex]

When a line segment of a highlight in the selected state is clicked on, vertex insertion mode of highlight is set.

Memo

A vertex can also be inserted by using [Insert vertex] on the context menu that is displayed by clicking the right button on a highlight in the selected state.

[Moving a highlight]

When an inside of a highlight in the selected state is clicked on, entire shift mode of highlight is set.

[Cancelling operation]

By clicking the right button, the vertex move, insertion, or highlight move mode can be cancelled.

(6) Plotted Position

[Moving a Plotted position]

When Plotted position in the selected state is clicked on, a Plotted position mode move is set.

[Cancelling operation]

By clicking the right button, the Plotted position move mode can be cancelled.

3.14.8 Manual updating

3.14.8.1 Unsaved object

The operation of AUTO mode of unsaved objects is the same as for the user chart.

3.14.8.2 Saved object

When setting an edit mode by clicking on the saved object, the property screen of the saved object is displayed.

3.14.8.3 C-MAP chart

When the C-MAP chart is updated manually and any of the following conditions is satisfied, the updated object is deleted automatically.

- The database has been updated.

3.14.9 Buoy object

When a buoy object is clicked on, a pick cursor is displayed at the clicked point and the [Chart Info] tab of the [Pick Report] dialog box is displayed.

Memo

The pick cursor indicates a square frame that is displayed at the point from which the chart information was read and the chart object information inside of the frame is displayed in the [Pick Report] dialog.

3.14.10 Light object

When a light object is clicked on, a pick cursor is displayed at the selected point and the [Chart Info] tab of the [Pick Report] dialog box is displayed.

Memo

The pick cursor indicates a square frame that is displayed at the point from which the chart information was read and the chart object information inside of the frame is displayed in the [Pick Report] dialog.

3.14.11 EBL

When EBL is clicked, the mode becomes one in which EBL is operated alone.

3.14.12 VRM

When VRM is clicked, the mode becomes one in which VRM is operated alone.

3.14.13 EBL/VRM intersecting point

When the EBL/VRM intersection point is clicked, the mode becomes one in which EBL and VRM are operated simultaneously.

3.14.14 Node Fixed EBL/VRM

When Node Fixed EBL/VRM is clicked on, the clicked point becomes the EBL/VRM intersecting point, and an EBL/VRM (1step) drawing mode is set. (The start point follows the own ship's position.)

3.14.15 PI

Four PI setting modes are available and the operation of the cursor AUTO mode varies depending on the setting.

For the details, refer to "4.6 Using Parallel Index Line (PI)".

3.14.16 WPT of Monitored Route

When a WPT of a monitored route is clicked on, the detail information of the WPT is displayed.

3.14.17 Monitoring dragging anchor

3.14.17.1 Object in the unselected state

When a monitoring dragging anchor object is clicked on, the clicked object is set to the selected state and the [Anchor Watch] dialog box is displayed.

3.14.17.2 Selected state

Dragging anchor monitoring circle

[Changing a radius]

When a square of the four corners of a dragging anchor monitoring circle in the selected state is clicked on, radius setting mode of dragging anchor monitoring circle is set.

[Cancelling operation]

By clicking the right button, the dragging anchor monitoring circle move or radius change mode can be cancelled.

Dragging anchor monitoring polygon

[Moving a vertex]

When a vertex of a dragging anchor monitoring polygon in the selected state is clicked on, a vertex move mode of dragging anchor monitoring polygon is set.

[Inserting a vertex]

When a line segment of a dragging anchor monitoring polygon in the selected state is clicked on, a vertex insertion mode of dragging anchor monitoring polygon is set.

Memo

A vertex can also be inserted by using [Insert vertex] on the context menu that is displayed by clicking the right button on a dragging anchor monitoring polygon in the selected state.

[Cancelling operation]

By clicking the right button, the vertex move, insertion or dragging anchor monitoring polygon move mode can be cancelled.

3.14.18 Planned route

[WPT]

When WPT in the unselected state is clicked on, WPT is in the selected state and WPT edition mode is set.

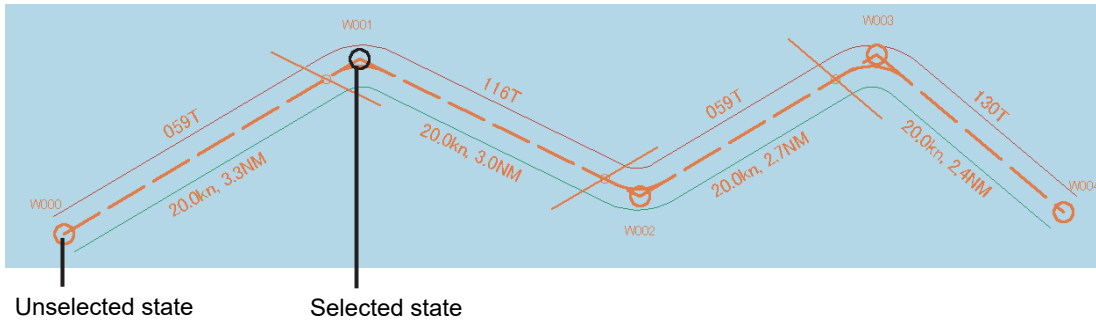

By clicking on the right button, the WPT move mode can be cancelled.

[Leg]

When Leg in the unselected state is clicked on, WPT is in the selected state and WPT insert mode is set.

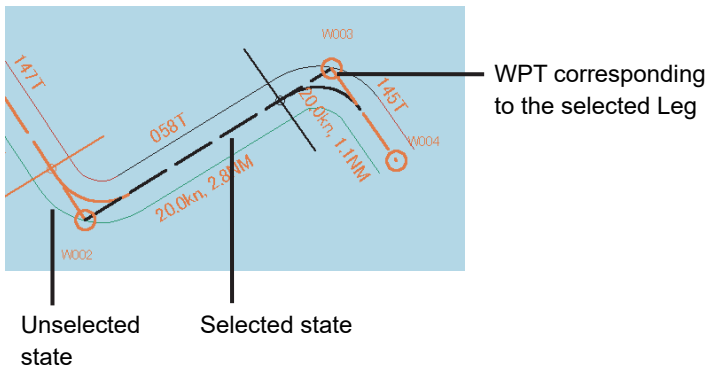

By clicking the right button, the WPT insertion mode can be cancelled.

[PORT]

When PORT in the unselected state is clicked on, PORT is in the selected state and PORT width change mode is set.

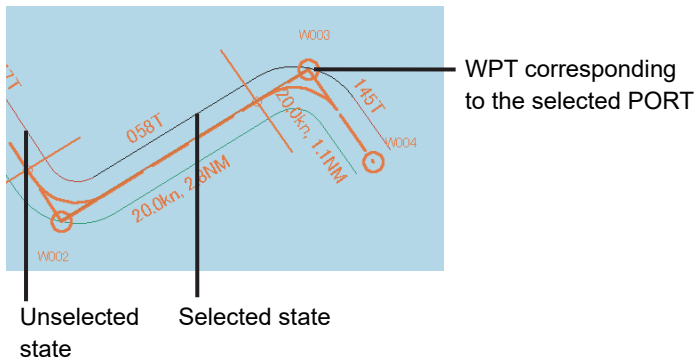

By clicking the right button, the PORT width change mode can be cancelled.

[STBD]

When STBD in the unselected state is clicked on, STBD is in the selected state and STBD width change mode is set.

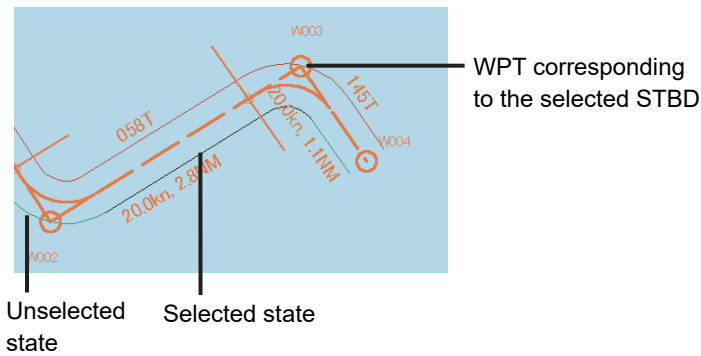

By clicking the right button, the STBD width change mode can be cancelled.

3.15 Saving the screen that is currently displayed

The image that is displayed on the screen can be saved as a PNG file.

Use the following procedure to save screen images.

- 1 Click on the Disclosure button on the left toolbar.



Normally, hidden buttons are displayed.

- 2 Click on the screen capture button.



The screen that is currently displayed is saved and the next confirmation dialog box is displayed.

When the screen contents cannot be saved:

When the screen contents cannot be saved due to insufficient disk free space, an error dialog is displayed.

In this case, secure sufficient disk free space and save the contents again.

3.16 [MULTI] Dial

3.16.1 Functions of [MULTI] dial

By turning the [MULTI] dial, the functions that are assigned to the [MULTI] dial can be operated. Assignment to the [MULTI] dial can be changed.

3.16.2 Functions assigned to [MULTI] dial

3.16.2.1 Displaying a screen for setting the function that is assigned

By pushing the [MULTI] dial, the setting screen for the function that is currently assigned can be displayed.

Assigned function name



3.16.2.2 Changing the function that is assigned

1 Press the [MULTI] dial.

The [Key Assignment] dialog box of the assigned function is displayed.

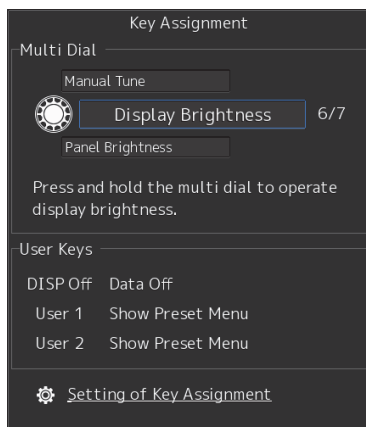

2 Select a function to be assigned from [Multi Dial] by turning the [MULTI] dial.

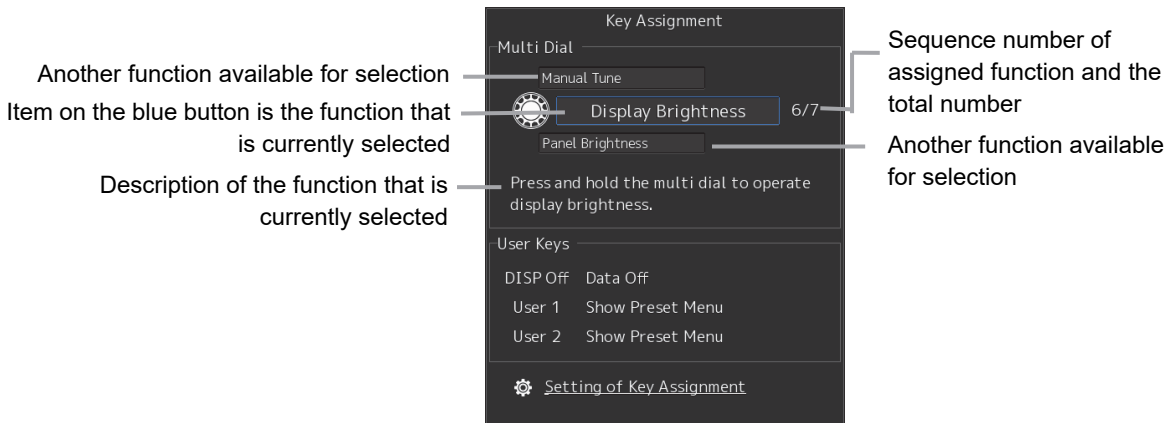

The table below lists the functions that can be assigned.

No.	Function name	Function outline
1	Vector Time	Selection of a vector length
2	C UP Angle	Change of the course-up angle
3	Own Track Color	Selection of an own track color
4	Display Brightness	Adjustment of brightness of the display panel
5	Panel Brightness	Adjustment of brightness of the operation panel
6	Gain	Adjustment of sensitivity
7	Sea	Removal of sea clutter
8	Rain	Removal of rain and snow clutter

3 Press the [MULTI] dial.

The selected function is set to the assigned function.

3.17 Basic Operations of the Software Keyboard

Use a software keyboard for inputting numeric values and characters in various setting operations. This section describes the basic operations of a software keyboard.

3.17.1 Starting a software keyboard

When the mouse button is clicked on a numeric input text box on such as a dialog box, a numeric input software keyboard is displayed.

When the mouse button is clicked on a character input text box, a character input software full keyboard is displayed.

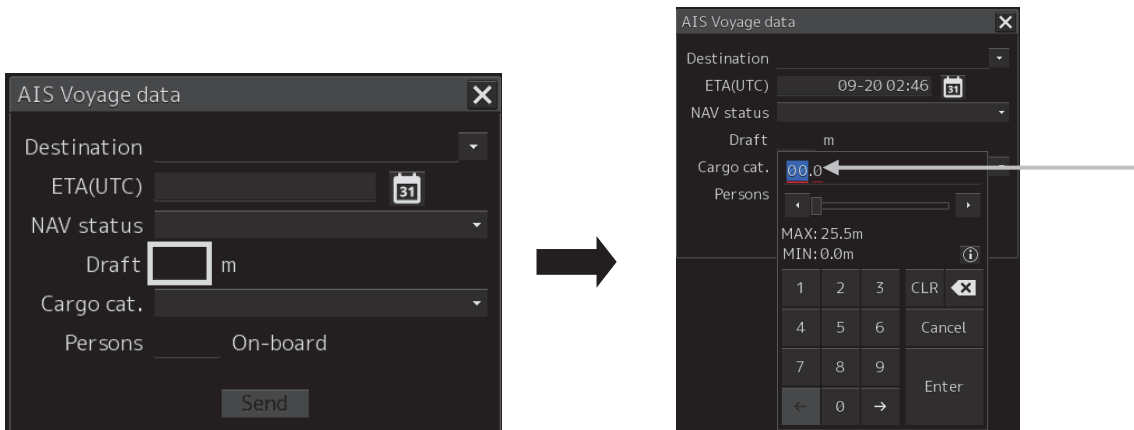

The mouse cursor moves to the inside of the software keyboard.

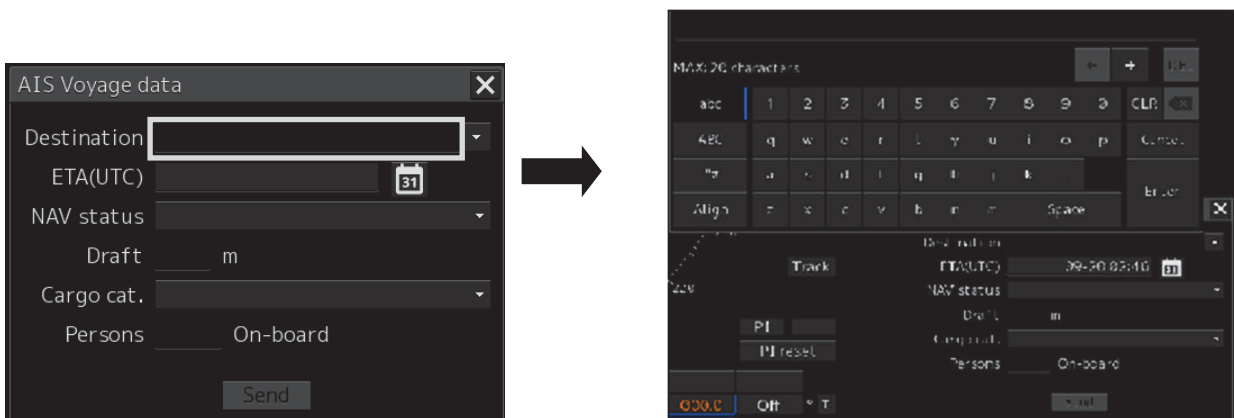

3.17.2 Name and function of each section of the keyboard

Numeric value input software keyboard

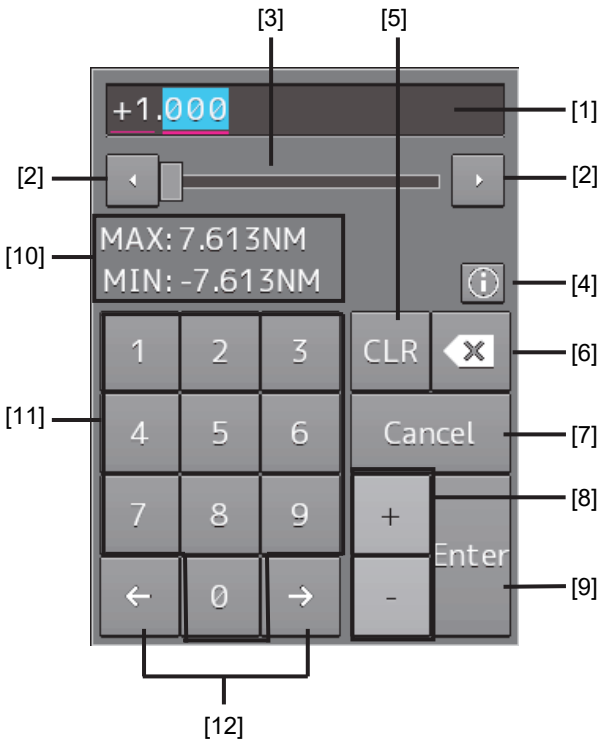

Software full keyboard for character input

* The description of the functions common to those of a numeric value input software keyboard is omitted.

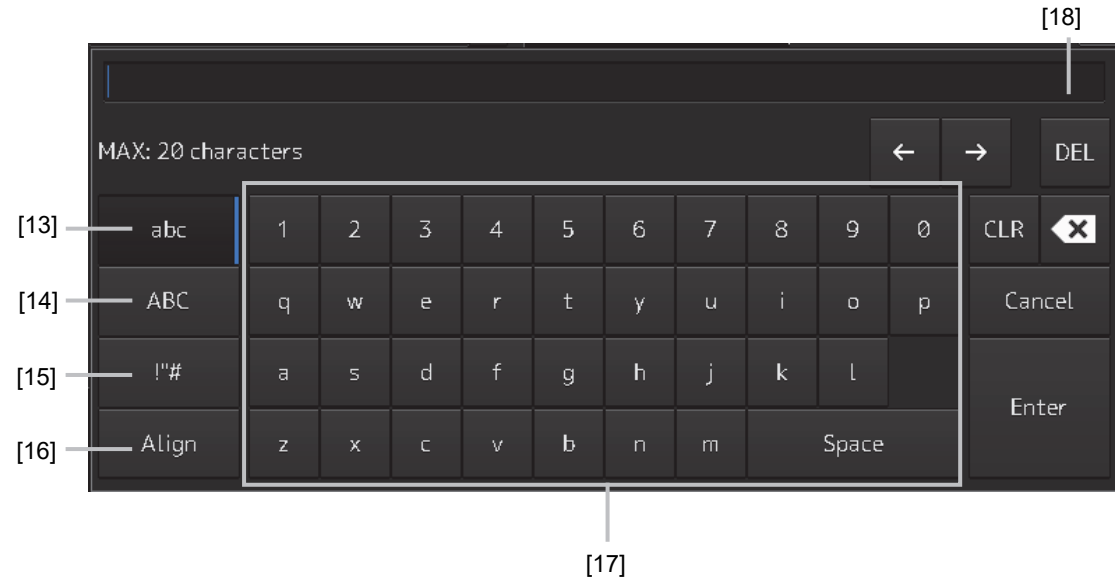

[1] Input value display section

Displays the value that is input/edited through the software keyboard.

[2] Spin button

- When the right spin button is clicked on, the minimum unit value that can be set is added to the value that is displayed. When the left spin button is clicked on, the minimum unit value that can be set is subtracted from the value that is displayed.

35° 00.000' N



36° 00.000' N

Example of addition

- When the mouse button is held down on the right spin button, the value is added consecutively. When the mouse button is held down on the left spin button, the value is subtracted consecutively.
- When the value set by the right spin button operation exceeds the maximum value, the minimum value is set subsequently. When the value set by the left spin button operation becomes lower than the minimum value, the maximum value is set subsequently.

[3] Numeric value slider

When the value adjustment button on the value slider is clicked on, the input value increases or decreases.

[4] Operation guide display button

Displays an operation guide.

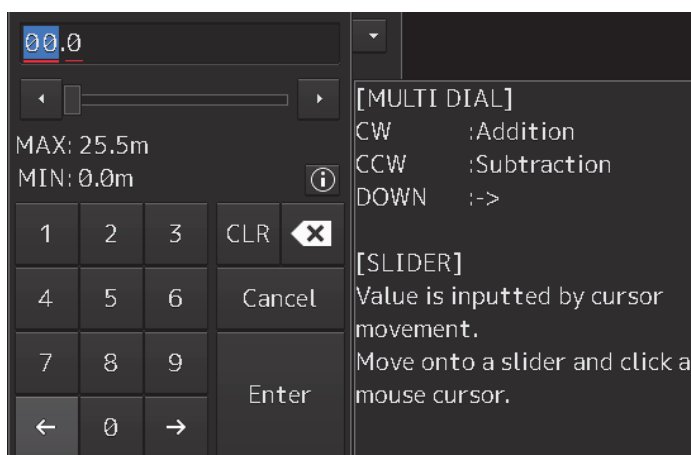

To close the operation guide, click on the operation guide display button again or click on a location other than the operation guide.

[5] [CLR] key

Clears the input value that is currently selected.

[6] Back Space key

Clears the input value on the left-side of the cursor position.

[7] [Cancel] key

Cancels the input operation and closes the software keyboard.

[8] Option key

Displays the following keys according to the type of the software keyboard.

- Signed keyboard: + key and - key
- Latitude software keyboard: Direction key [N key and S key)
- Longitude software keyboard: Direction key [E key and W key)

[9] [Enter] key

Determines the input operation.

[10] Input range display section [format display section)

Displays the values and character types that can be input.

[11] Numeric keys

Use the keys for input of numeric values.

[12] Arrow keys

When there are multiple input sections, the active part can be moved to the left/right by clicking on the arrow key.

Example:



When the [left arrow key) is clicked on, the input section moves to "12".

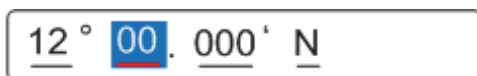

When the [right arrow key) is clicked on, the input section moves to "000".

**[13] Lowercase character switching key**

Changes the character input key mode to the lowercase character mode.

[14] Uppercase character switching key

Changes the character input key mode to the uppercase character mode.

[15] Symbol switching key

Changes the character input key mode to the symbol mode.

[16] Key alignment switching key

Switches the character key alignment between QWERTY alignment and alphabetic alignment.

[17] Character input key

Use this key for character input.

[18] [DEL] key

Deletes the character on the left-side of the cursor.

3.17.3 Numeric value input example

In this example, "12°34.567' S" (south latitude 12°34.567') is input as the latitude.

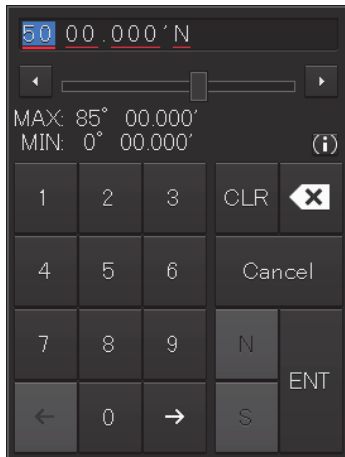

1 Start up the latitude software keyboard.

35° 00.000' N

2 Enter "1".

1° 00.000' N

3 Enter "2".

12° 00.000' N

The active part moves to the right by one position.

4 Enter "3".

12° 3.000' N

- 5 Enter "4".

12 ° 34 . 000 ' N

The active part moves to the right by one position.

- 6 Enter "5" and "6".

12 ° 34 . 56 ' N

- 7 Set the input part at the right end as the active part (by clicking on "N" in this example).

12 ° 34 . 560 ' N

- 8 Click on the [S] key of the Option key.

"N" changes to "S".

12 ° 34 . 560 ' S

- 9 When the right arrow key is clicked, input is determined and the software keyboard is closed.

Inputting a single-digit value

Enter a value and click on another input part or move the active part by using the right arrow key.

Example:

35 ° 00 . 000 ' N



Enter 1.

1 ° 00 . 000 ' N



The value that is input by clicking on another input part or the right arrow key becomes a single-digit value and the value is determined. 0 is input in the blank space.

01 ° 00 . 000 ' N

Inputting blank space in the decimal fraction section [3 digits)

After a value is input and the [Enter] key is clicked on, the input of the decimal fraction section is determined.

Example

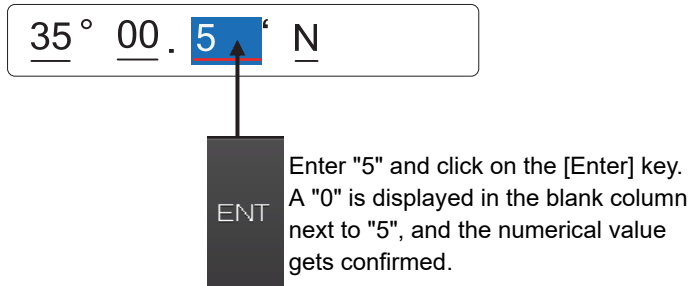

3.17.4 Character input example

This section describes character input by using a full keyboard.

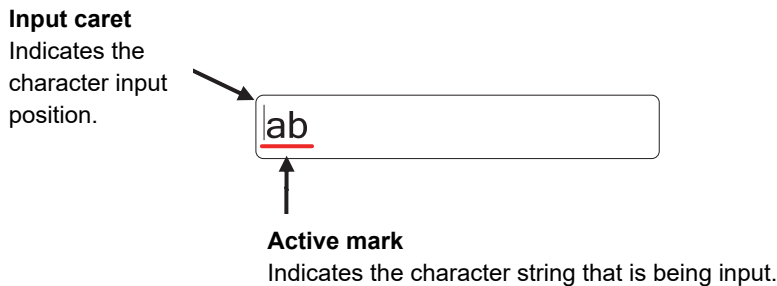

Input example

1 Start up a full keyboard.

When a value (character) has been input in the text box, the full character string is selected at startup.



2 Delete the character string by clicking the Back Space key.



3 Input any character string.



4 Determine the input by clicking on the [Enter] key.

Character modification example

- 1 Move the cursor to the left-end (or right-end) of the character string to be modified and click the mouse button.



The input caret moves to the clicked position.



- 2 Click the mouse button on the input caret position and select the character string to be modified by dragging with the trackball.

*When the character string is selected, the input caret is cleared.



- 3 Perform the following operation in the selected state.

[Deleting a selected section]



When the Back Space key is clicked on, the selected section is deleted.



[Replacing a selected section]

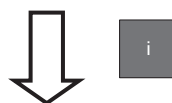

Input any character in the selected state. (In this example, "i" is input.)



[Canceling a selected state]



Under a selected state, click on another section inside of the active mark to cancel the selection. The input caret moves to the clicked position.



- 4 After modification is determined, determine the input by clicking on the [Enter] key.

3.18 Setting a Date and a Time (Calendar Operation)

Set a date and a time on the calendar input screen.

The following calendar types are available.



Calendar picker

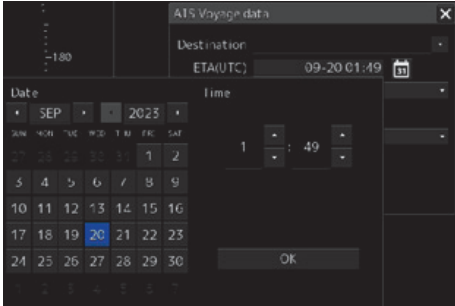

Calendar picker + Time picker

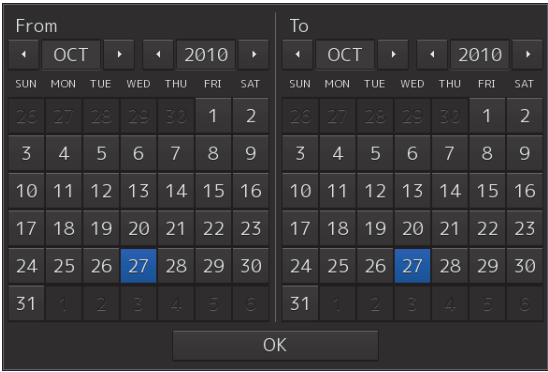

From-To calendar picker

3.18.1 Details and usage of a calendar picker and a time picker

3.18.1.1 Details of a calendar

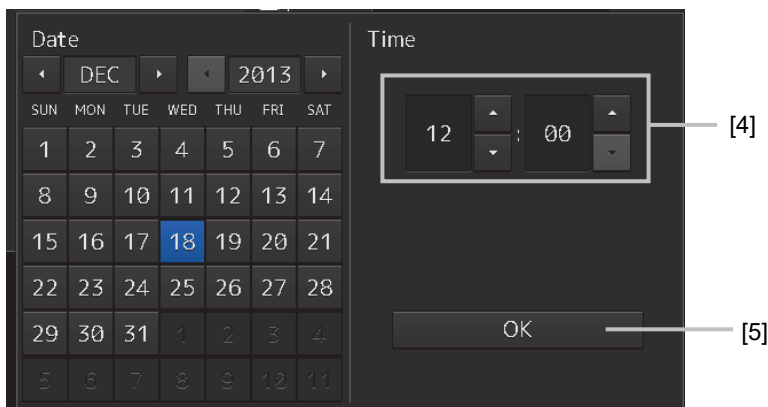
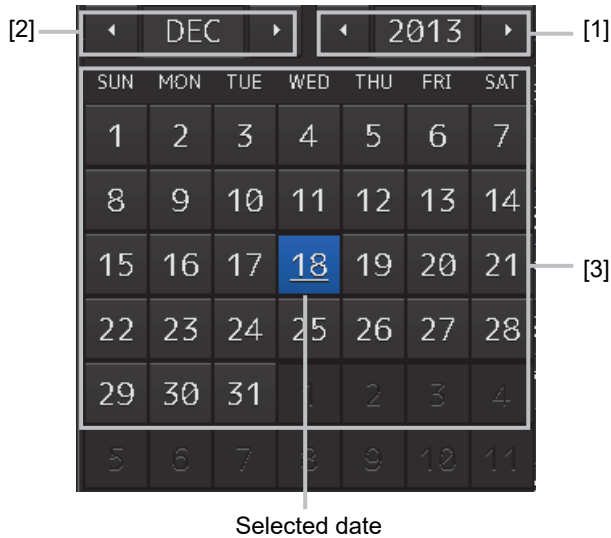

[1] Year selection spin button

Selects a year to be displayed in the date selection box.

- When the right spin button is clicked on, the year is changed in the ascending order.
- When the left spin button is clicked on, the year is changed in the descending order.

[2] Month selection spin button

Selects a month to be displayed in the date selection box.

- When the right spin button is clicked on, the month is changed in the ascending order.
- When the left spin button is clicked on, the month is changed in the descending order.

[3] Day selection box

Selects a day.

[4] Time selection spin button

Sets an hour, a minute, and a second.

- When the upper spin button is clicked on, the hour, minute, and second are changed in the ascending order.
- When the lower spin button is clicked on, the hour, minute, and second are changed in the descending order.

[5] [OK] button

Completes the setting and closes the calendar.

3.18.1.2 How to use a calendar

- 1 Click on  (calendar) button next to the date setting box.

A calendar is displayed.

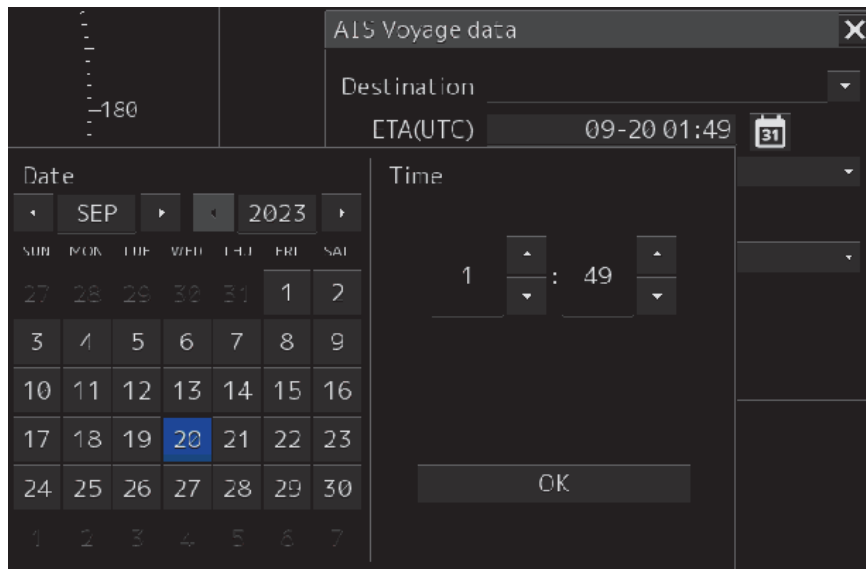

- 2 Set a year and a month by using the year selection spin button and the month selection spin button respectively.
- 3 Click on the day to be set from the day selection box.
* In the case of a calendar picker only, the day is set at this stage and the calendar picker is closed.
- 4 Set a time by clicking on the time spin button of the time picker.
- 5 Click on the [OK] button.
The setting is completed and the calendar is closed.

3.19 Help

Help information on the operation of this equipment can be displayed.
For the details of installation of Help, refer to “19.7 Updating Help data”.

Memo
The Preface, Section 1 and Appendix A are not displayed in the Help.

1 Click on the [Menu] button on the left toolbar.

The menu is displayed.

2 Click on the [Help] button on the menu.

The [Help] dialog box appears.



[1] Backward button

The display of the content display pane goes backwards by one.

[2] Forward button

The display of the content display pane goes forwards by one.

[3] [Contents] tab

Displays the contents. The contents are displayed in the content pane.

For the usage method, refer to “**Searching the required information from the contents**”.

[4] Content pane

The contents are displayed in tree format. When an item is clicked on, the related contents are displayed in the content display pane.

[5] Home button

Displays the home screen of the [Help] dialog box.

[6] [Search] tab

Searches the character string in Help.

For the procedure, refer to "Searching terminologies".

[7] Content display pane

Displays the contents of the item that was clicked on.

[8] [×] button.

Closes the [Help] dialog box.

Searching the required information from the contents

1 Click on the [Contents] tab.

The contents are displayed on the contents pane.

2 Click on the item containing the required information.

The contents of the item that was clicked on are displayed on the contents display pane.

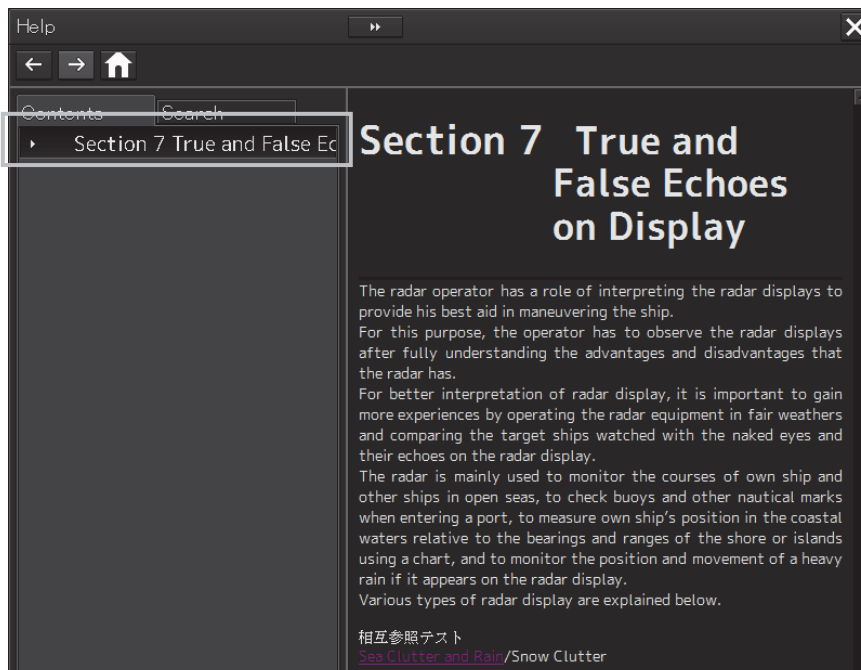

Searching terminologies

1 Click on the [Search] tab.

A search character input box is displayed.

2 Enter a required terminology and click on the [Search] button.

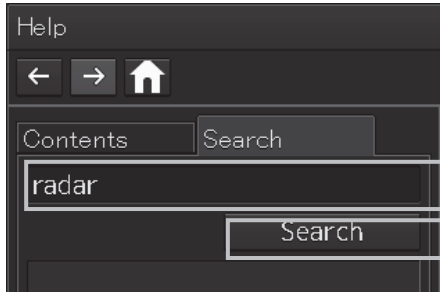

Search is performed within Help. When the applicable terminology is hit, the item containing the terminology is displayed on the contents pane.

3 Click on the item containing the required information.

The contents of the item that is clicked on are displayed on the contents display pane.

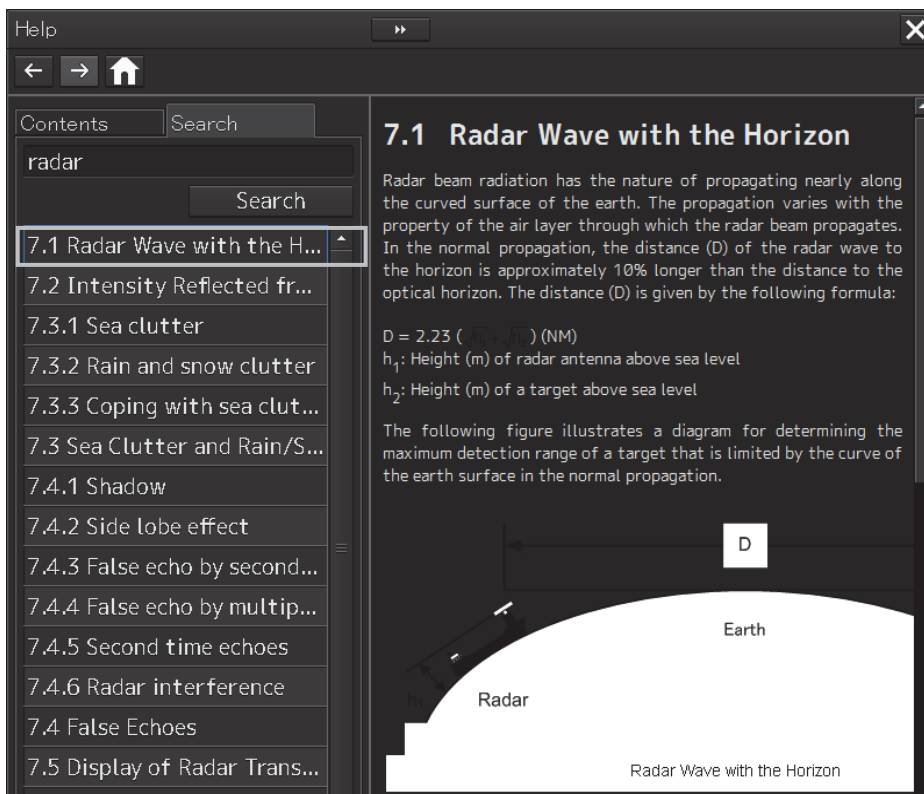

3.20 Password Input

Equipment settings are protected by a password. To open the dialog box of the protected setting function, the password input is necessary.

Use the following procedure to enter a password.

- 1 Click on the [Menu] button on the left toolbar.



The menu is displayed.

- 2 Change over to the second page of the menu using the page switching button of the menu.
- 3 Click on the [Code Input] button on the Menu.

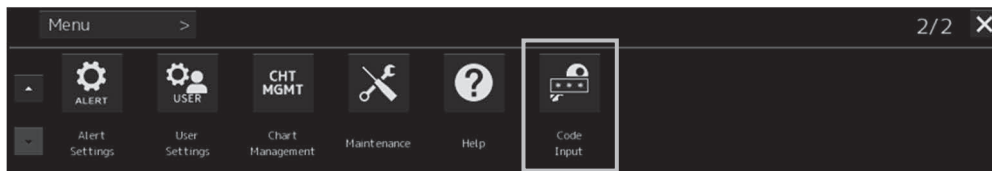

The password input dialog box appears.

- 4 Enter "0" (zero) and click on the [Enter] key.

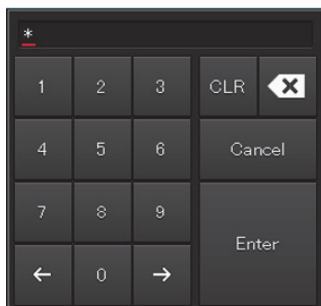

- 5 Display the menu by clicking again the [Menu] button on the left toolbar, and change over to the second page using the page switching button.

The [Service] button is displayed in the menu.

- 6 Click on the [Service] button.

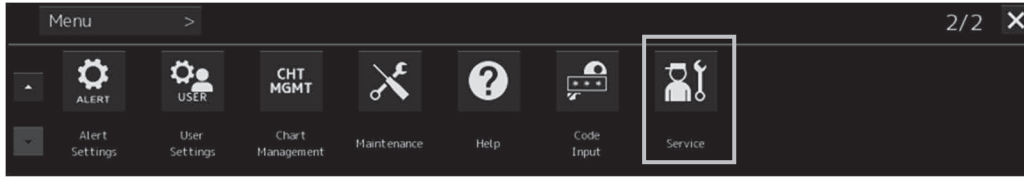

Check that service-related menus are displayed in the sub-menu.

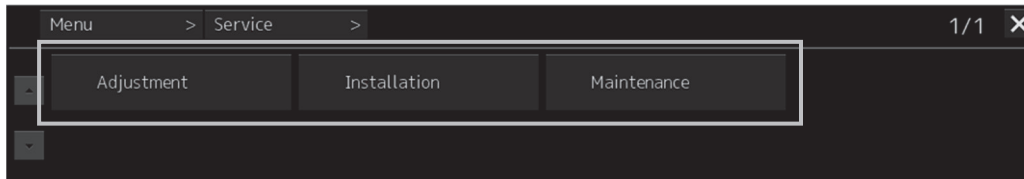

Subsequently, service-related menus can be set.

3.21 Managing Files with File Manager

The file manager function enables the copying of route files and user chart from the hard disk of this equipment to external storage media such as DVD or from external storage media to the hard disk of this equipment.

3.21.1 Displaying the [File Manager] dialog box

- 1 Click on the [Menu] on the left toolbar.**
The menu is displayed.
- 2 Click on the [Tools] - [File Manager] button on the menu.**
The [File Manager] dialog box appears.

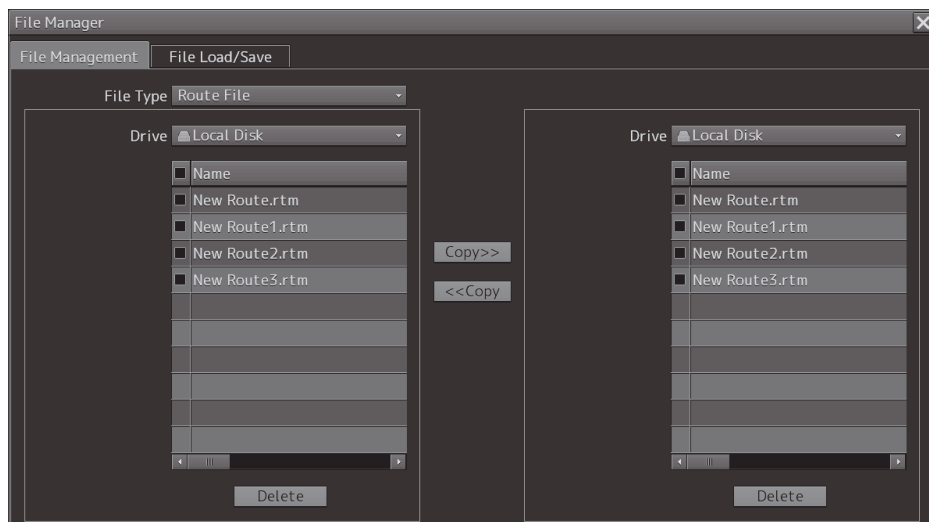

3.21.2 File management

The [File Management] tab enables file management.

File management copies files between SSD of this equipment and external storage media and deletes files.

This section describes file management by using the example copying a file in the file list of the drive that is specified in the [Drive] list on the left hand side of the dialog box to the drive that is specified in the [Drive] list on the right hand side. .

1 Click on the [File Management] tab.

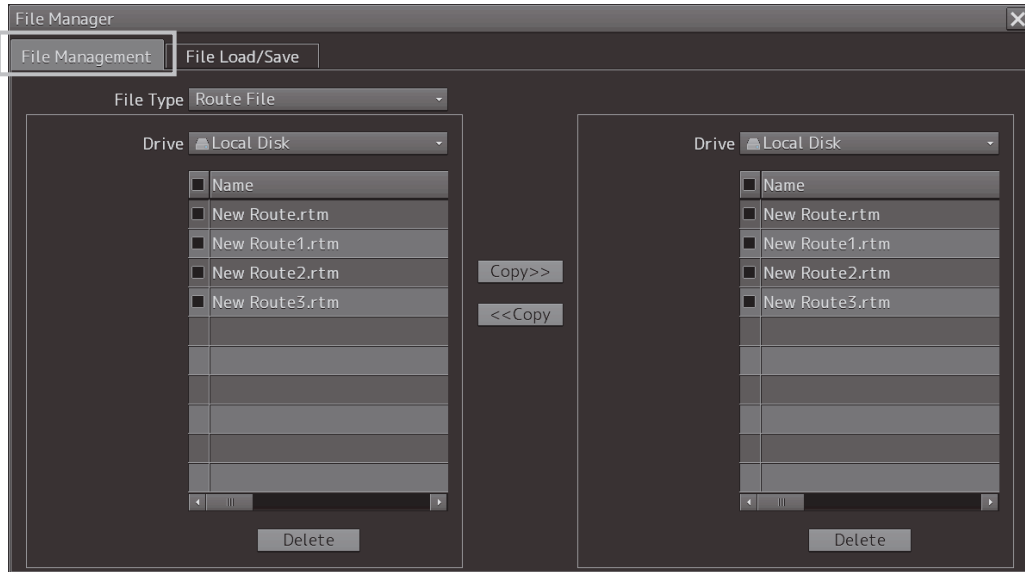

2 Select the drive that contains the file to be copied from the [Drive] combo box.

Files in the drive are displayed in the list.

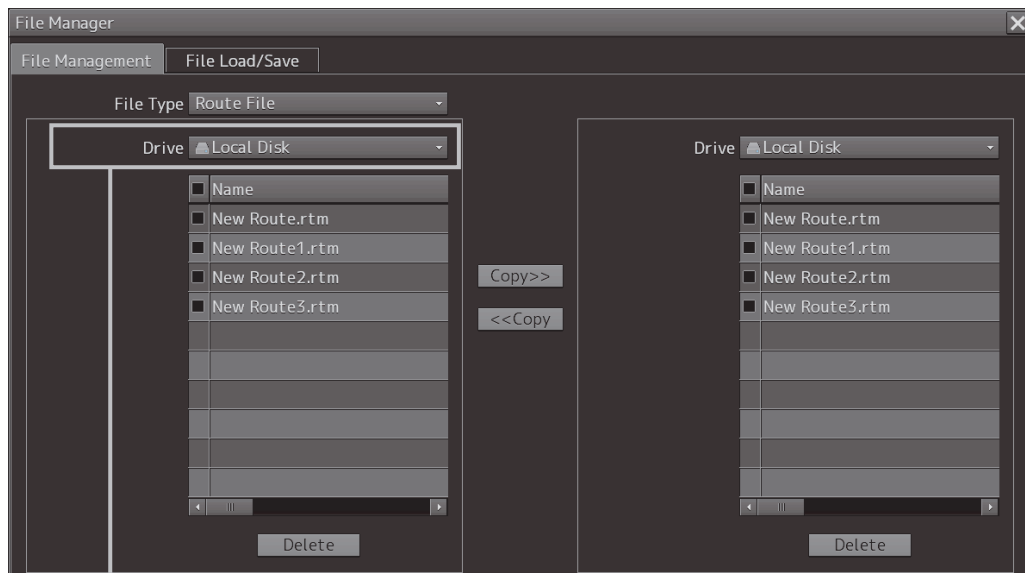

[Drive] combo box

The following file types can be displayed by the file manager.

No.	File type	File extension	Contents
1	Route File	rtm	Route
2	User Chart	uchm	Chart map
3	Target Track	ttr	Track of other ship [including the GPS buoy]
4	Screen Shot (AUTO)	png	Automatically generated screen shot
5	Screen Shot (User)	png	Manually created screen shot
6	Preferences	ini	Personal setting
7	Voyage Log	pbl, index, pbo, rot, pbt	Playback data
8	Logbook	lgb, lgblst	Logbook (for up to 3 months)

3 Select the files to be copied by checking them.

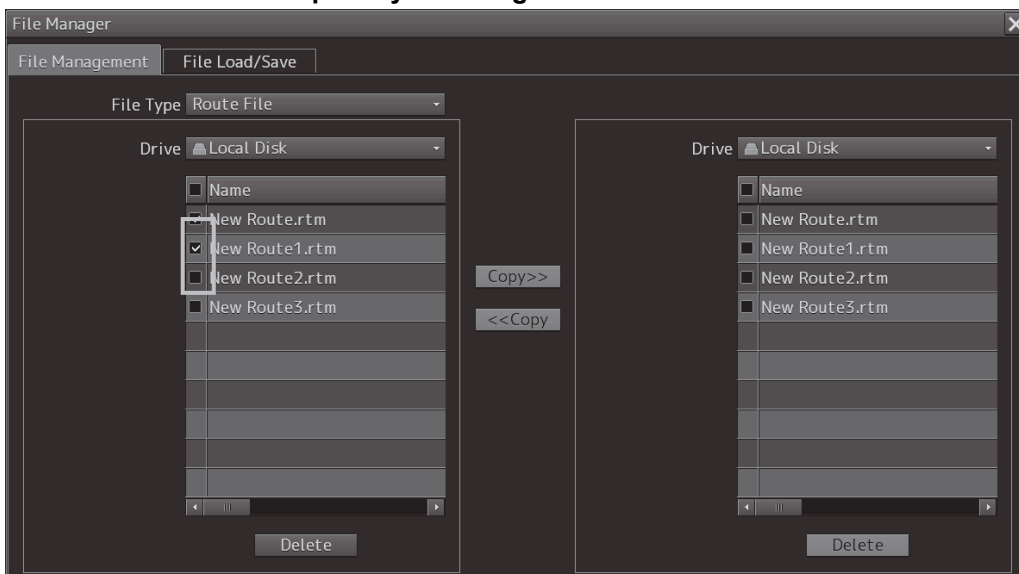

- 4 Select a drive of the storage destination from the [Drive] combo box and select a copy location from the folder tree that is displayed.

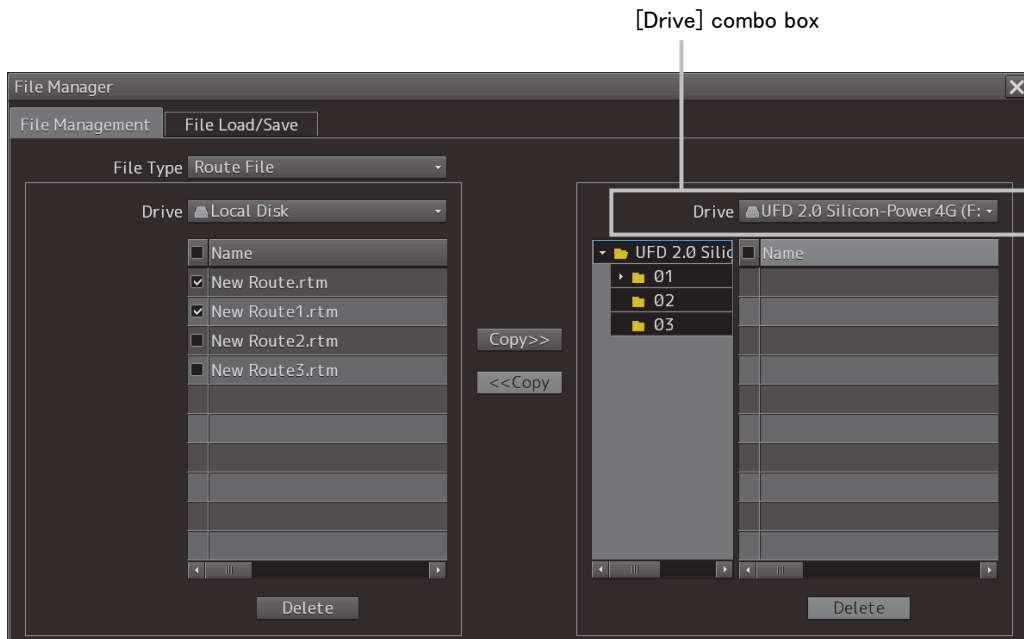

- 5 Click on the [Copy>>] (copy to the right) button.

The files are copied.

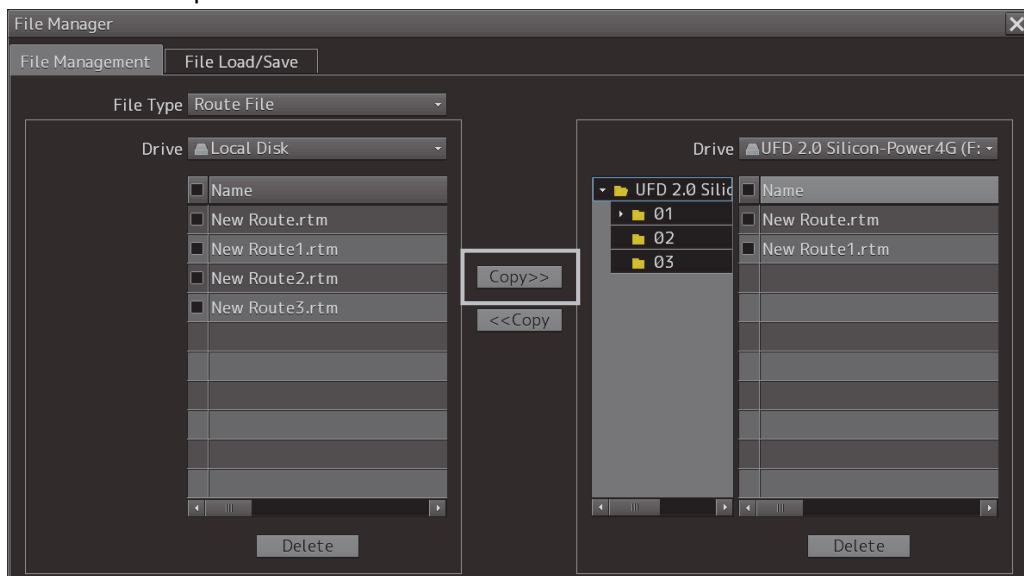

When the drive of the copy source and the drive of the copy destination are reversed, click on the [<<Copy] (copy to the left) in Step 5.

Deleting a file

- 1 Click on the [Delete] button.
A deletion confirmation dialog is displayed.
- 2 To delete the file, click on the [OK] button.

3.21.3 Loading and saving files

The [File Load/Save] tab enables loading and saving files.

3.21.3.1 Loading files

- 1 Click on the [File Load/Save] tab.

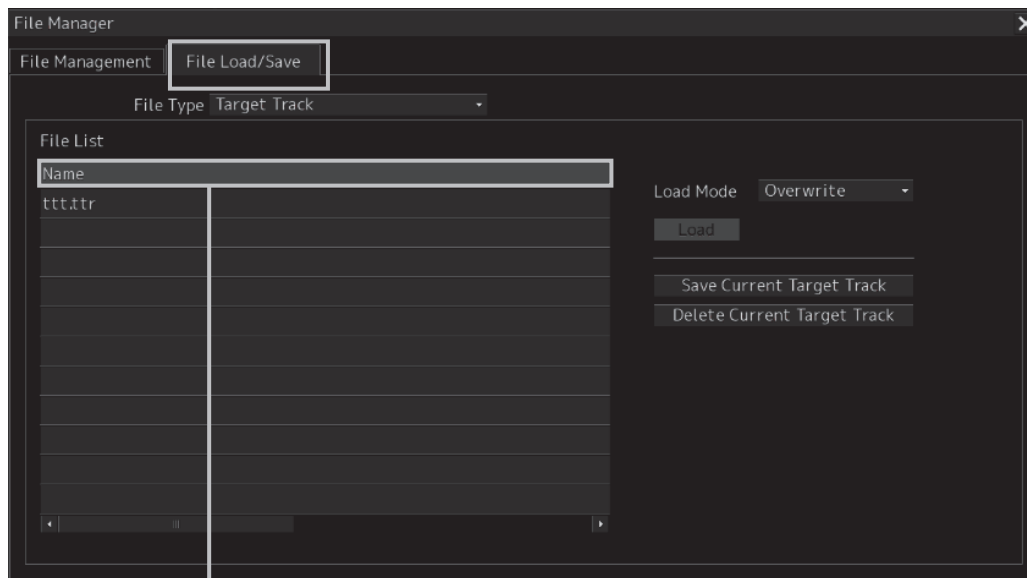

[Name] (file name)

2 Check [Display] of the file to be loaded.

Memo

Only one file can be selected each time.

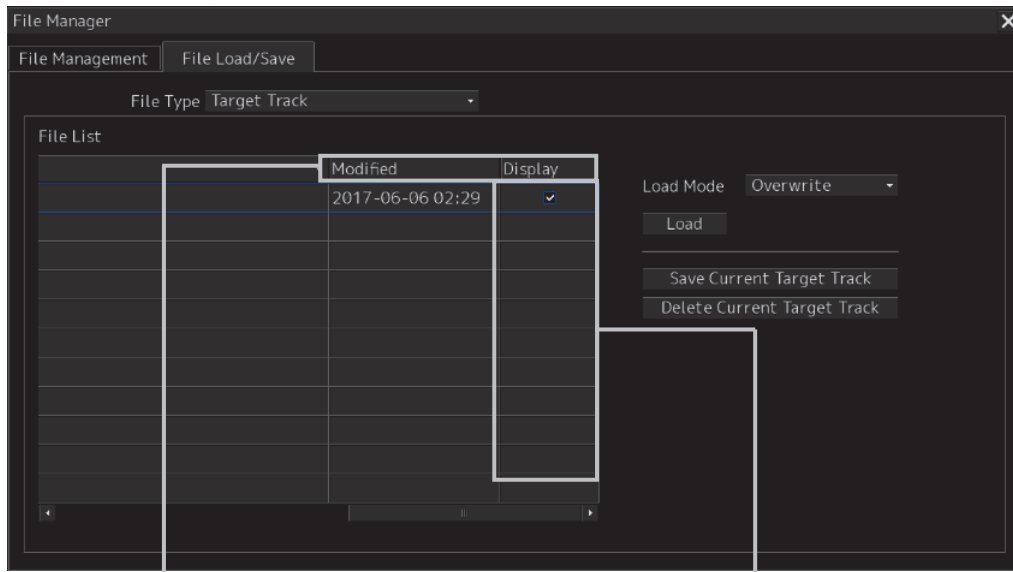

[Modified] (last modified date)

[Display] (column check box)

Each title is sorted in the ascending/descending order whenever the button is clicked on.

Temporarily displays the Track of the line that was checked.

When the line is unchecked, the line is hidden.

3 Select the file loading mode from the [Load Mode] combo box.

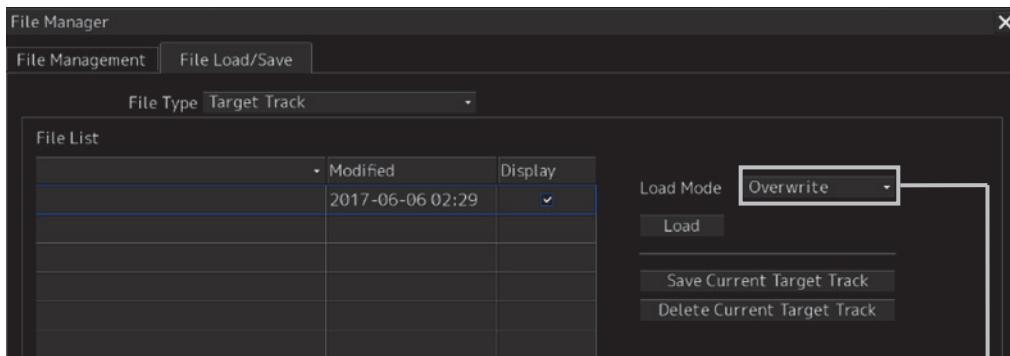

One of the following modes is displayed.

- [Overwrite]
- [Add]

4 Click on the [Load] button.

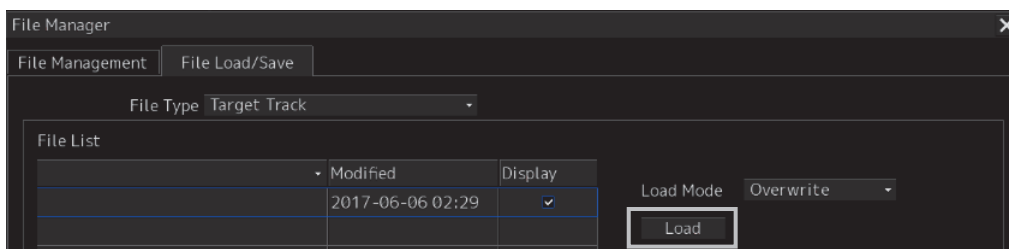

A confirmation dialog box appears.

- 5 Click on the [OK] button.

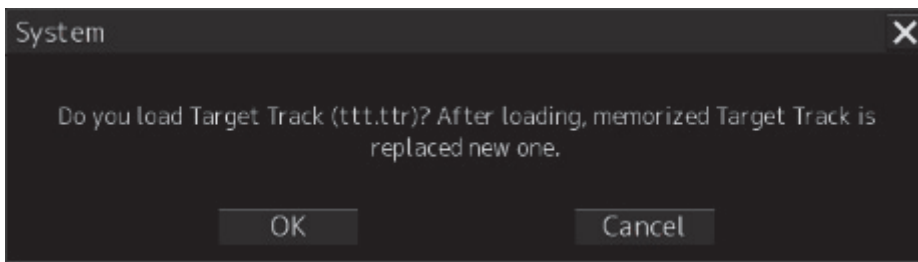

The selected file is loaded.

3.21.3.2 Saving files

- 1 Click on the [File Load/Save] tab.
- 2 Select a file type from the [File type] combo box.
- 3 Click on the [Save Current Target Track] button.

Memo

The name of the Save Current Target Track button varies according to the file type.

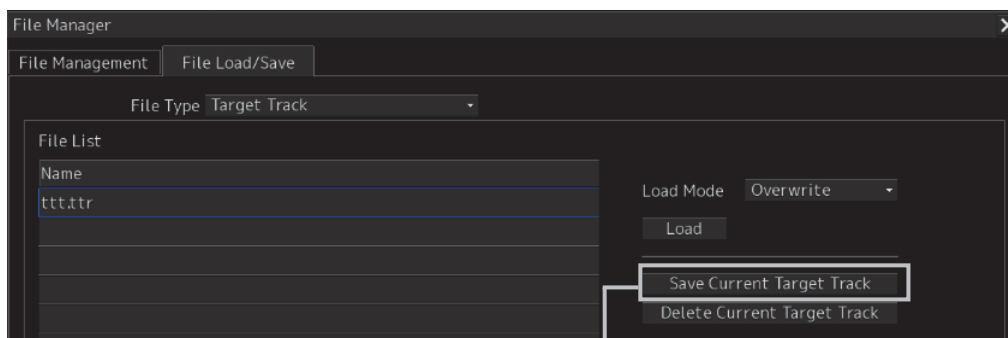

[Save Current Target Track] (save button)

A confirmation dialog box appears

- 4 Enter a name under which the file is saved in the input box and click on the [OK] button.

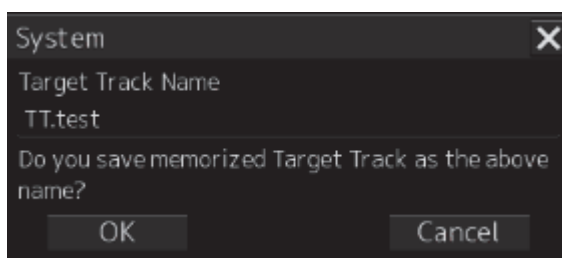

The Target Track that is stored is saved.

3.21.3.3 Deleting data

- 1 Click on the [File Load/Save] tab.
- 2 Select a file type from the [File type] combo box.
- 3 Click on the [Delete Current Target Track] button.

Memo

The name of the Delete Current Target Track button varies according to the file type.

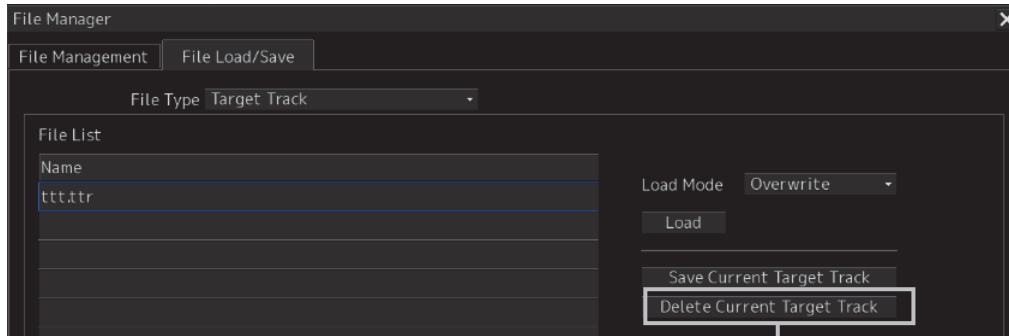

[Delete Current Target Track] (delete button)

A confirmation dialog box appears.

- 4 Click on the [OK] button.

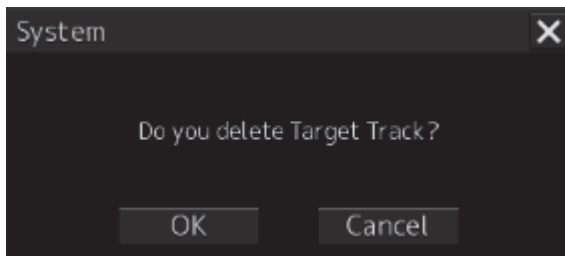

The Target Track data that is stored is deleted.

3.22 Returning to a Task Menu by Ending the Operation

- 1 Click on the [MENU] on the left toolbar.
The menu is displayed.



- 2 Change over to the second page of the menu using the page switching button of the menu.
- 3 Click on the [Code Input] button on the menu.

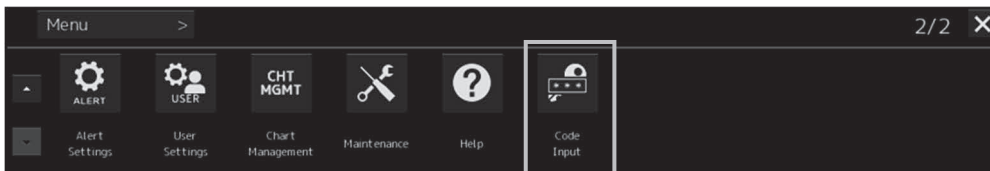



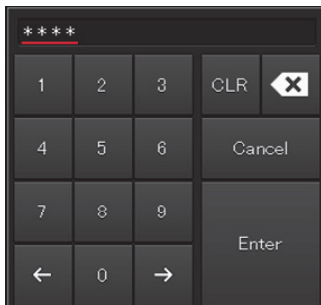

The password input dialog box appears.

- 4 Enter 9999 and click on the [Enter] key.

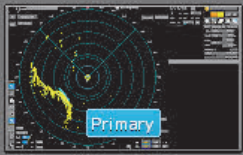

Returns to the task menu.

Task Menu

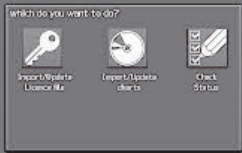
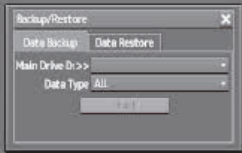
 Collision Avoidance (RADAR)	 Route Planning Route Monitoring (ECDIS)	 Navigation Data Monitoring (Conning Display)
 Playback	 Chart Maintenance	 Data Backup/Restore

Password

3.23 Terminating this equipment

WARNING





When turning off the power supply, do not hold down the power button of the operation unit. Otherwise, the equipment is not terminated normally, possibly causing a failure.

1 Press the power supply button on the operation unit.

The power is turned off and the light of power supply button goes off.

3.24 Using a DVD Drive

 **CAUTION**

 Do not leave the disc in the DVD drive.
Malfunctions of the drives may result.

A DVD drive is installed in the panel of this equipment.
Use the drive by removing the panel.

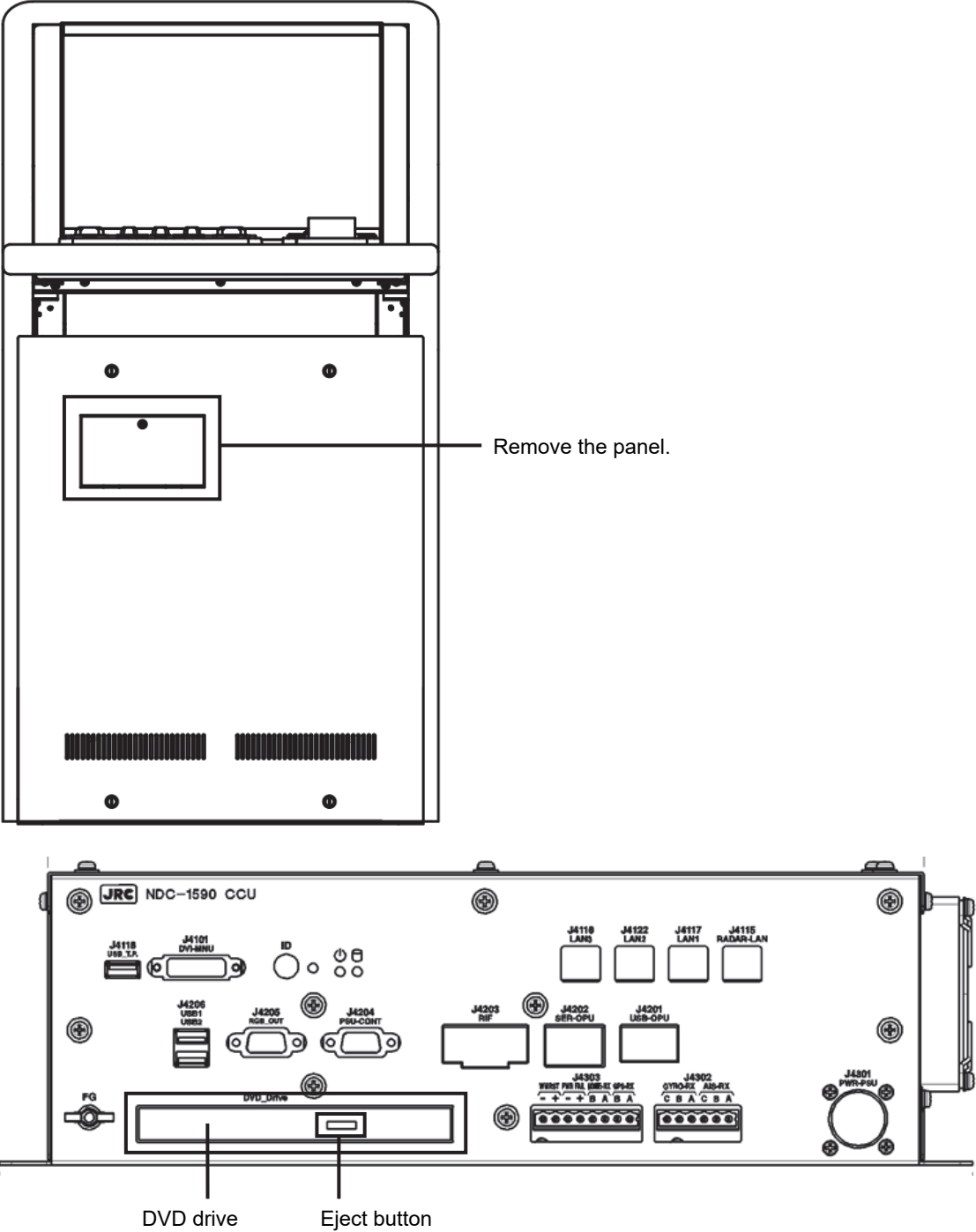

Note

Do not remove a DVD disk while the access lamp of the DVD drive is lit.

Section 4 Range and Bearing Measurement Methods

4.1 List of Measuring Tools

This equipment is equipped with the following measuring tools to measure the range and bearing.

Measuring tool	Function	Related section
Cross-Hair Cursor (Cursor)	Used to measure the range and bearing from the own ship's position.	4.3 Using the Cross-hair Cursor
Range Rings	Displays concentric circles having CCRP (Consistent Common Reference Point) as the center at constant intervals in order to be used as guidance for measuring the range.	4.4 Using the Range Rings
Electronic Bearing Lines (EBL1/EBL2)	Displays a straight line that specifies an arbitrary bearing in order to measure the bearing from own ship. The MFD is equipped with two electronic bearing lines (EBL1 and EBL2).	4.5 Using the Electronic Bearing Line (EBL) and Variable Range marker (VRM)
Variable Range Markers (VRM1/VRM2)	Displays a circle that specifies an arbitrary range in order to measure the range from own ship. The MFD is equipped with two variable range markers (VRM1 and VRM2).	
Parallel Index Lines (PI)	Displays a group of straight lines at equal intervals in order to be used for complex measurement and guidance for route.	4.6 Using Parallel Index Lines (PI)
EBL Maneuver	Displays a predictable track when own ship is turned in order to be used as guidance for maneuvering.	4.7 Using the EBL Maneuver
Node Fixed EBL/VRM	Connects the own ship's position and the specified fixed position with EBL and VRM markers. Since the connection is maintained even if own ship advances, the bearing and range of own ship against the fixed position is always available.	4.8 Connecting Own Ship and the Specified Fixed Position with EBL and the VRM Marker (Node Fixed EBL/VRM Function)
Manual position fix (LOPs)	Measures the own ship's position with LOP (Line Of Position) and plots it on the chart. The own ship's position can be jumped to the plotted position.	4.9 Measuring the Own Ship's Position Manually (LOPs Fixing Function of Manual position fix)
Manual position fix (Position Offset)	Enables offsetting the own ship's position with manual operation.	4.10 Offsetting the Own Ship's Position Manually (Position Offset Function of Manual position fix)

4.2 Target Position

The radar transmits the pulse-modulated radio waves. The transmitted waves are received in the target after being reflected (echoed). On the screen, the waves spread in the pulse width range direction based on the target position as the front edge.

When measuring a target or setting a mark/line on the target, place the cursor on the front edge of the echo.

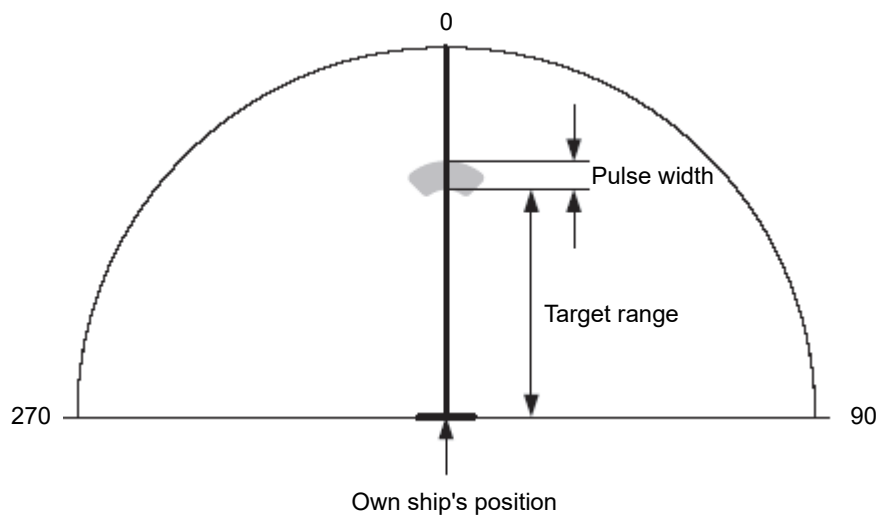
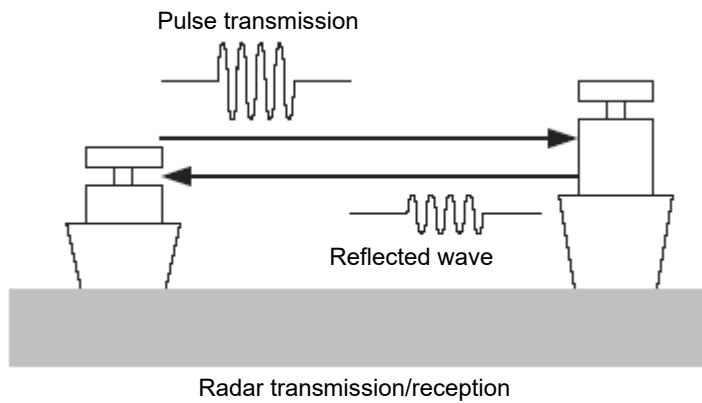

Relationship of range between the echo and the target and the pulse width

4.3 Using the Cross-hair Cursor

When moving the cursor into a window, it changes to a cross-hair cursor. With the cross-hair cursor, the bearing and position of a target can be measured.

The information that is measured by the cursor is displayed in the cursor readout information area.

4.3.1 Cursor readout information area display position

Use the following method to display the information.

1 Click the [Menu] button on the left toolbar.

The menu is displayed.

2 Click on [Tools] - [Cursor Readout] on the menu.

The [Cursor readout] dialog box appears.

The display mode of the [Cursor readout] dialog can be switched between standard display and expanded display by clicking on the Disclosure button.

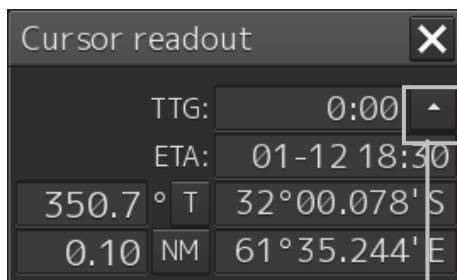

Disclosure button

Standard display

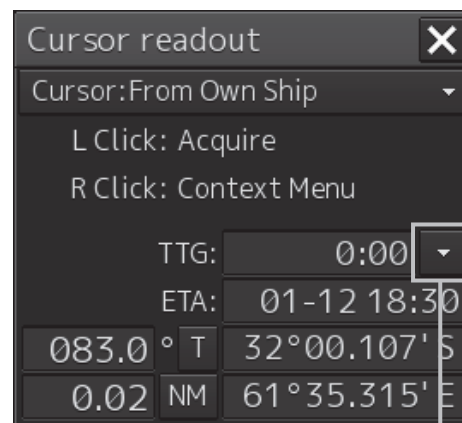

Disclosure button

Expanded display

To close the [Cursor readout] dialog box

Click the [X] button.

4.3.2 Measuring the bearing and the range from the own ship's position to the target by using the cross-hair cursor

The measurement method is as follows.

- 1** Click the [Menu] button on the left toolbar.
The menu is displayed.
- 2** Click on [Tools] - [Cursor Readout] on the menu.
The [Cursor readout] dialog box appears.

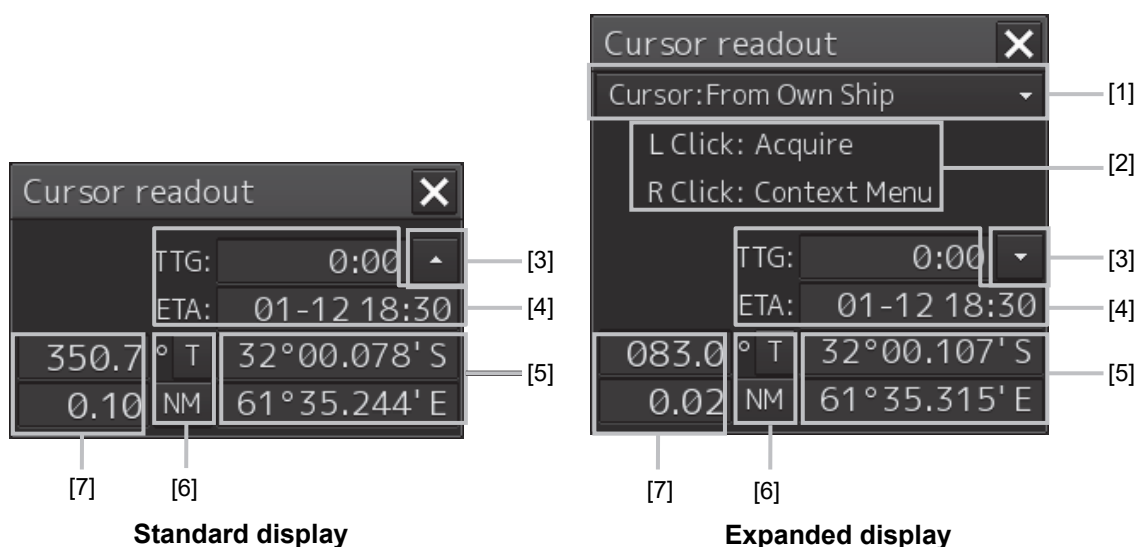

[1] Cursor bearing/range reference point switching combo box

Set a cursor bearing/range reference point.

- * Only [Cursor:From Own Ship] which makes own ship's position a bearing/range reference point to the cursor can be selected.

[2] Operation hint

Displays the operation hint of the trackball button.

[3] Disclosure button

By clicking on the button, the display mode of the [Cursor readout] dialog can be switched between standard display and expanded display.

[4] TTG display and ETA display

Displays TTG and ETA from the ship's own position to the cursor position.

[5] Latitude and longitude of the cursor position

Displays the latitude and longitude of the cursor position.

[6] Cursor bearing True/Relative display and cursor range unit display

For the details, refer to "4.3.2.1 Switching the cursor bearing between True/Relative" and "4.3.2.2 Switching the cursor range unit".

[7] Cursor bearing display and cursor range display

Displays the bearing and range from CCRP to the cursor.

4.3.2.1 Switching the cursor bearing between True/Relative

The cursor bearing mode can be switched between True/Relative in the [Cursor readout] dialog box.

- 1** Display the [Cursor readout] dialog box.
- 2** Click on the cursor bearing True/Relative switching button.

Whenever the button is clicked on, the display is switched between [T] and [R].

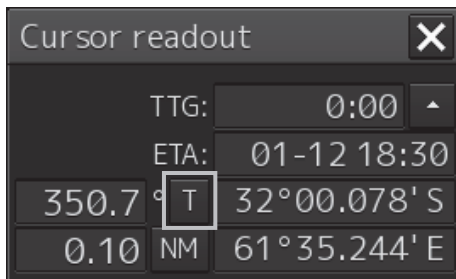

[T]: Displays the cursor bearing in True mode.

[R]: Displays the cursor bearing in Relative mode.

4.3.2.2 Switching the cursor range unit

The cursor range unit can be switched in the [Cursor readout] dialog box.

- 1** Display the [Cursor readout] dialog box.
- 2** Click on the cursor range unit switching button.

Whenever the button is clicked on, the display is switched to [NM], [sm], or [km].

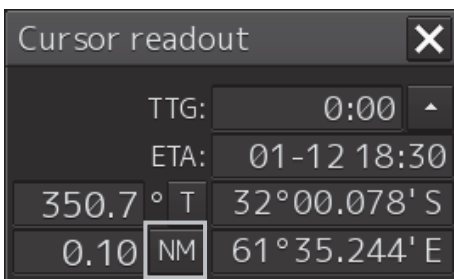

[NM]: Displays the range in the unit of NM.

[sm]: Displays the range in the unit of sm.

[km]: Displays the range in the unit of km.

Memo

NM indicates nautical miles, sm indicates surface miles, and km indicates kilometers.

4.4 Using the Range Rings

Range rings are multiple concentric circles displayed on the screen.

Using range rings on the screen, the range to a target can be measured by determining at which scale interval the target is positioned.

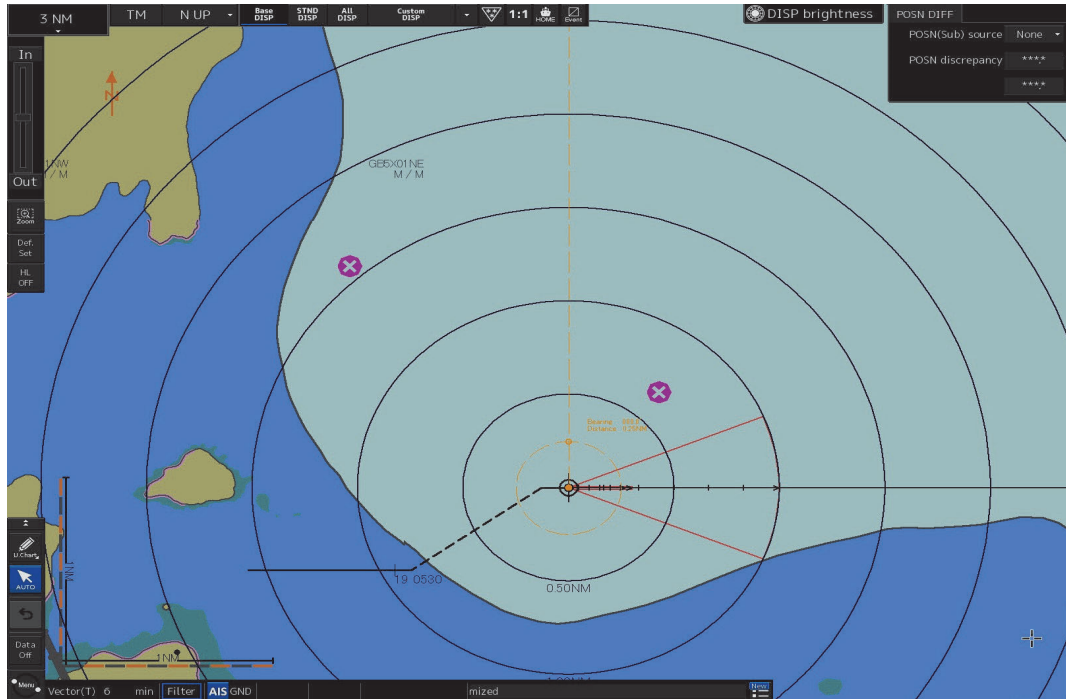

*For clarity, the color of the range rings is displayed in black.

The display of range rings can also be turned on/off on the switching range rings button on the left toolbar.

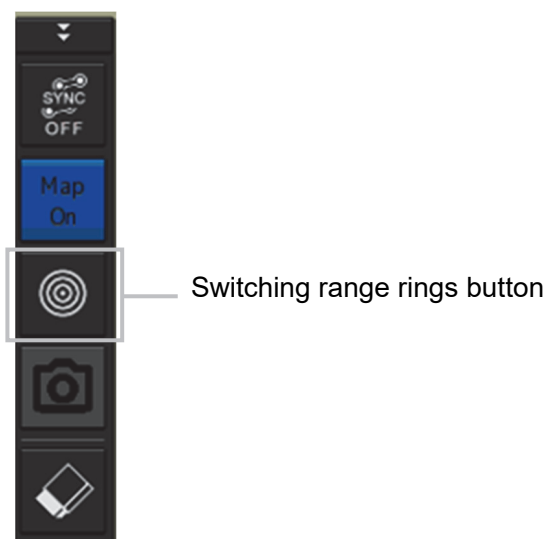

The display of range rings can also be turned on/off according to the following procedure.

1 Click the [Menu] button on the left toolbar.

The menu is displayed.

2 Click [View] - [Options] - [Tools] on the menu.

The [View-Options] dialog box appears.

3 Click [Range Rings].

Whenever the button is clicked on, the display is switched between On and Off.

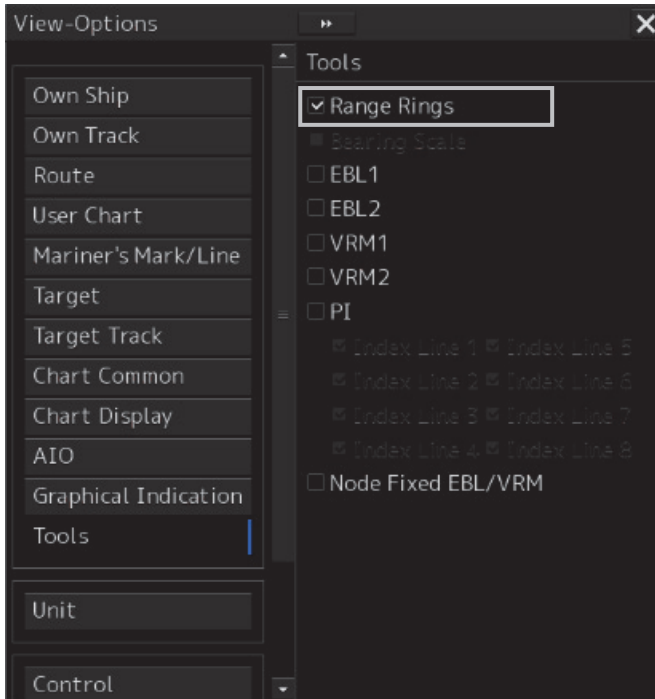

Memo

The green color can be set in the dialog which is displayed by selecting [Settings] - [General] - [Color and Brightness] on the menu.

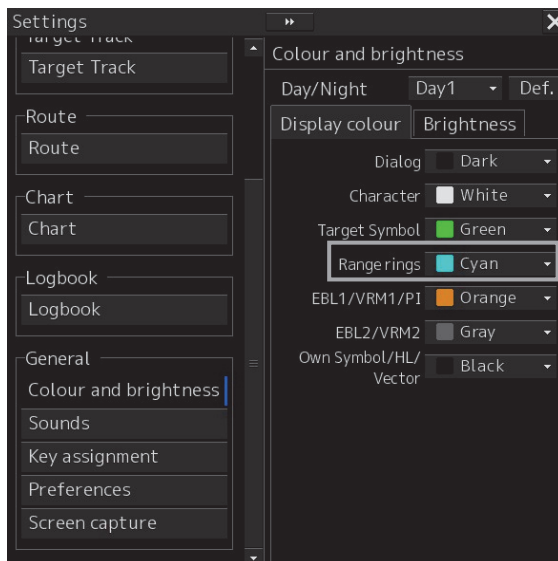

4.5 Using the Electronic Bearing Line (EBL) and Variable Range marker (VRM)

4.5.1 Measuring a range and a bearing with EBL and VRM

4.5.1.1 Measuring in the trackball operation unit

When the cursor is in AUTO mode, EBL and VRM can be operated on the trackball operation unit. This section describes the manipulation under EBL1 and VRM1; however, the same manipulation can be performed under EBL2 and VRM2 also.

- 1 Enable the manipulation of EBL1 by clicking on the [EBL1] button.

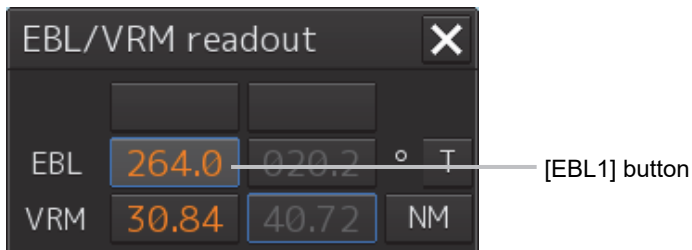

- 2 Align the cursor with a target and click on the mouse button.
The bearing of the target is displayed on the [EBL1] button.

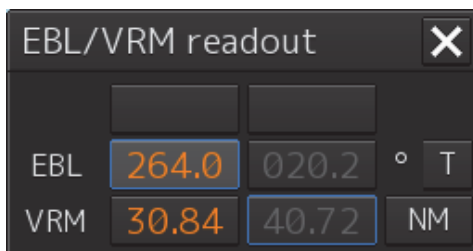

- 3 Enable the manipulation of VRM1 by clicking on the [VRM1] button.

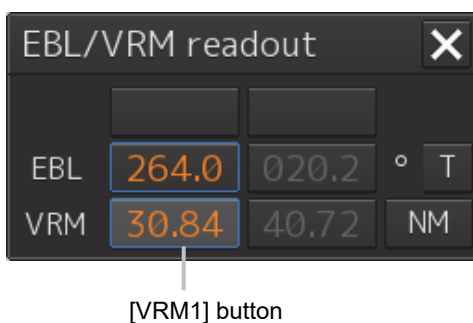

4 Align the cursor with a target and click on the mouse button.

The range of the target is displayed on the [VRM1] button.

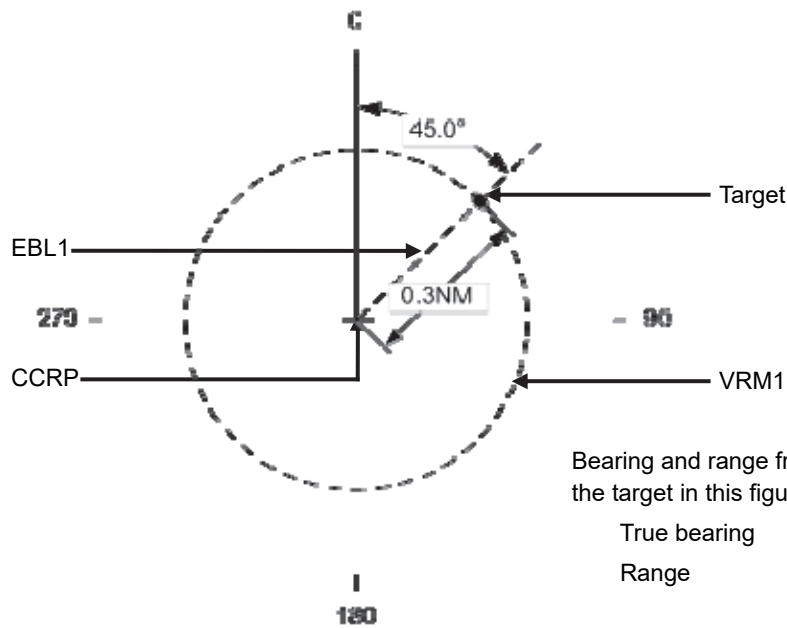
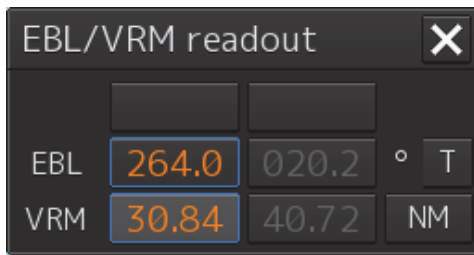

Bearing and range from the own ship's position to the target in this figure:

True bearing	45.0°
Range	0.30 NM

4.5.1.2 Measuring with the [EBL] or [VRM] dial on the keyboard operation unit

1 Press the [EBL] dial.

The context menu is displayed.

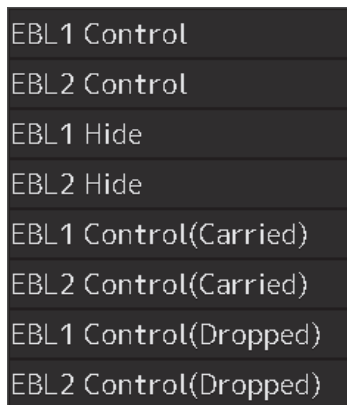

2 By turning the dial, select either [EBL1 Control] or [EBL2 Control].

3 Press the [EBL] dial.

If [EBL1 Control] is being selected, manipulation of EBL1 is enabled.

If [EBL2 Control] is being selected, manipulation of EBL 2 is enabled.

4 By turning the [EBL] dial, align the EBL with a target.

The bearing of the target is displayed on the [EBL1] button.

5 Press the [VRM] dial.

The context menu is displayed.



6 By turning the dial, select either [VRM1 Control] or [VRM2 Control].

7 Press the [VRM] dial.

If [VRM1 Control] is being selected, manipulation of VRM1 is enabled.

If [VRM2 Control] is being selected, manipulation of VRM2 is enabled.

8 By turning the [VRM] dial, align the VRM with a target.

The range of the target is displayed on the [VRM1] button.

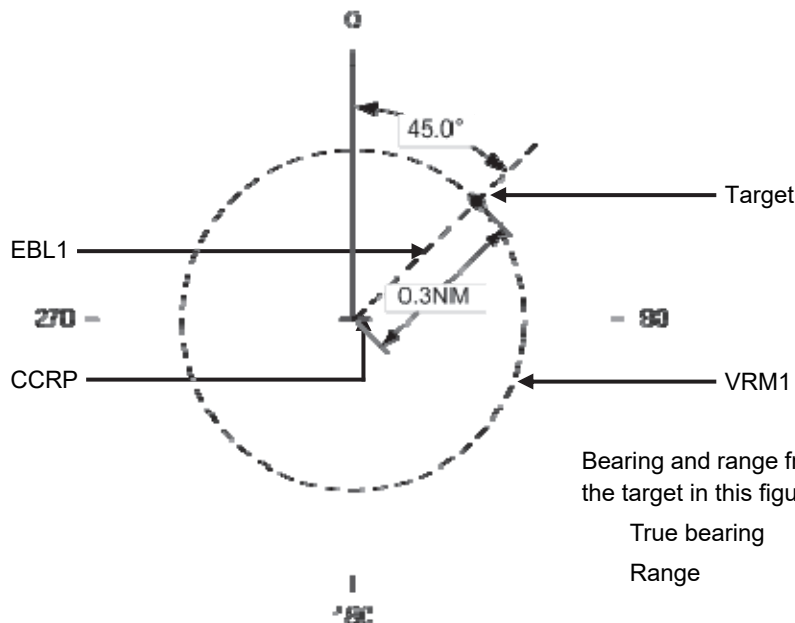

Bearing and range from the own ship's position to the target in this figure:

True bearing	45.0°
Range	0.30 NM

To clear the EBL:

1 Press the [EBL] dial.

The context menu is displayed.

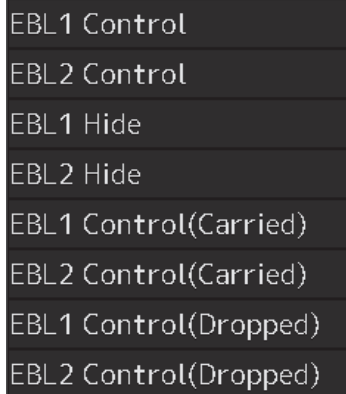

2 By turning the dial, select either [EBL1 Hide] or [EBL2 Hide].

3 Press the [EBL] dial.

If [EBL1 Hide] is being selected, the selection of EBL1 is cleared.

If [EBL2 Hide] is being selected, the selection of EBL2 is cleared.

To change the measurement starting point of the EBL:

The measurement starting point can be changed from the own ship's position to another.

1 Press the [EBL] dial.

The context menu is displayed.

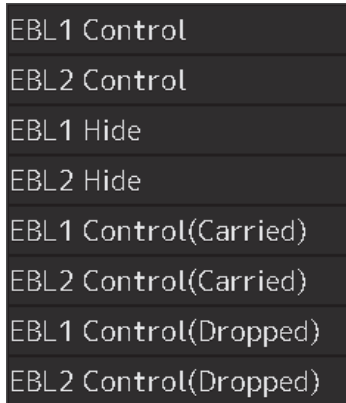

2 By turning the dial, select either [EBL1 Control (Carried)] and [EBL1 Control (Dropped)] or [EBL2 Control (Carried)] and [EBL2 Control (Dropped)].

3 Press the [EBL] dial.

If [EBL1 Control (Carried)] and [EBL1 Control (Dropped)] is being selected, manipulation of EBL1 is enabled.

If [EBL2 Control (Carried)] and [EBL2 Control (Dropped)] is being selected, manipulation of EBL2 is enabled.

4 Move the cursor to change the measurement starting point.

5 The measurement starting point is fixed by clicking on it.

To clear the VRM:

1 Press the [VRM] dial.

The context menu is displayed.



2 By turning the dial, select either [VRM1 Hide] or [VRM2 Hide].

3 Press the [VRM] dial.

If [VRM1 Hide] is being selected, the selection of VRM1 is cleared.

If [VRM2 Hide] is being selected, the selection of VRM2 is cleared.

4.5.2 Measuring between arbitrary two points

The range and bearing between arbitrary two points can be measured as follows.

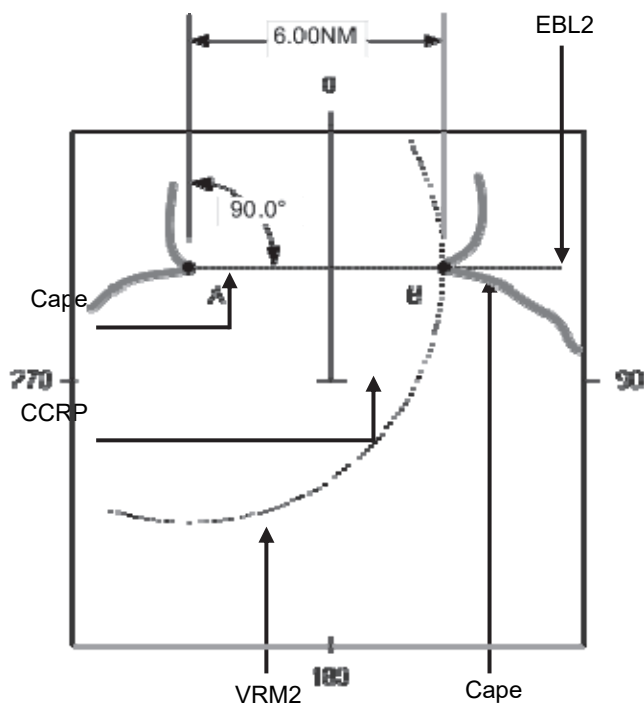

Here, the manipulation with EBL2/VRM2 is explained. The same operation can be performed with EBL1/VRM1.

- 1 Click on the measurement starting point button of EBL2/VRM2 and select [D].

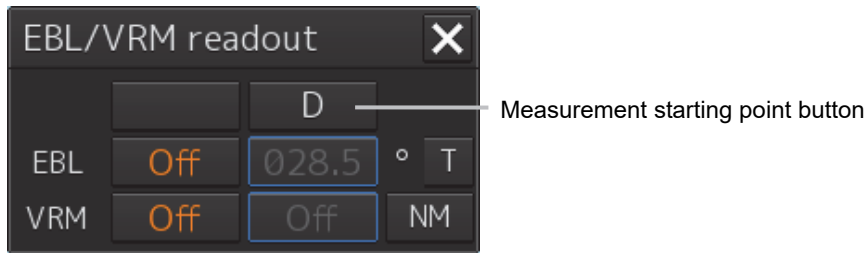

- 2 Enable the manipulation of EBL2 by clicking on the EBL2 button.

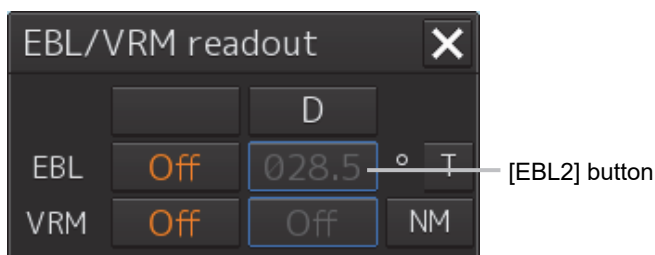

- 3 Align the cursor with “point A” of the two points to be measured and then click it on.
- 4 Enable the movement of EBL2 by clicking on the EBL2 line.
- 5 Align the cursor with bearing “point B” of the two points to be measured and then click it on.
- 6 Click the [VRM2] button to make VRM2 operable.

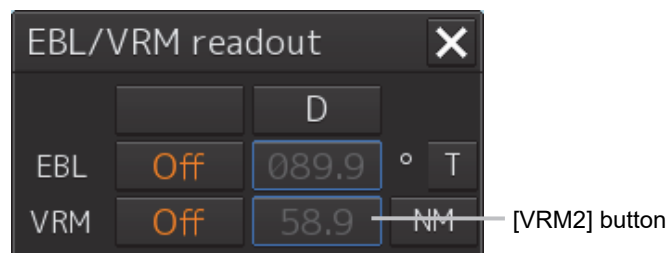

- 7 Move the intersecting point marker on the dotted line of EBL2 by the cursor and align it with point B.

The range and bearing between the two points are displayed.

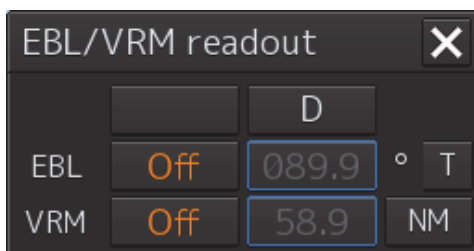

4.5.3 Manipulating EBL/VRM with the context menu

EBL/VRM can be manipulated with the context menu that appears by clicking on the screen.

The context menu of EBL/VRM consists of "Dropped EBL/VRM" that manipulates EBL/VRM by using an arbitrary position as the measurement starting point, and "CCRP EBL/VRM" that manipulates EBL/VRM by using the position of own ship as the measurement starting point.

Context menu	Related section
[Dropped EBL/VRM] - [Make EBL1/VRM1] or [Make EBL2/VRM2]	4.5.3.1 Manipulating EBL/VRM with [Dropped EBL/VRM] - [Make EBL1/VRM1] or [Make EBL2/VRM2]
[Dropped EBL/VRM] - [Make EBL1] or [Make EBL2]	4.5.3.2 Manipulating EBL with [Dropped EBL/VRM] - [Make EBL1] or [Make EBL2]
[Dropped EBL/VRM] - [Make VRM1] or [Make VRM2]	4.5.3.3 Manipulating VRM with [Dropped EBL/VRM] - [Make VRM1] or [Make VRM2]
[Dropped EBL/VRM] - [Move base point of EBL1/VRM1] or [Move base point of EBL2/VRM2]	4.5.3.4 Manipulating EBL/VRM with [Dropped EBL/VRM] - [Move base point of EBL1/VRM1] or [Move base point of EBL2/VRM2]
[CCRP EBL/VRM] - [Make EBL1/VRM1] or [Make EBL2/VRM2]	4.5.3.5 Manipulating EBL/VRM with [CCRP EBL/VRM] - [Make EBL1/VRM1] or [Make EBL2/VRM2]
[CCRP EBL/VRM] - [Make EBL1] or [Make EBL2]	4.5.3.6 Manipulating EBL with [CCRP EBL/VRM] - [Make EBL1] or [Make EBL2]
[CCRP EBL/VRM] - [Make VRM1] or [Make VRM2]	4.5.3.7 Manipulating VRM with [CCRP EBL/VRM] - [Make VRM1] or [Make VRM2]

[Dropped EBL/VRM]

On this context menu, EBL/VRM can be manipulated by using the measuring reference point as any position.

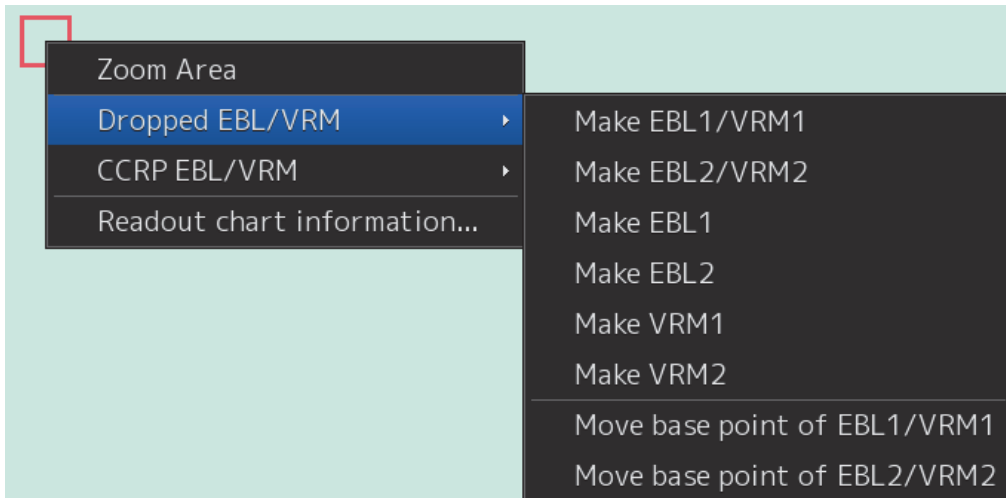
**[CCRP EBL/VRM]**

On this context menu, EBL/VRM can be manipulated by using the measuring reference point as the own ship's position.

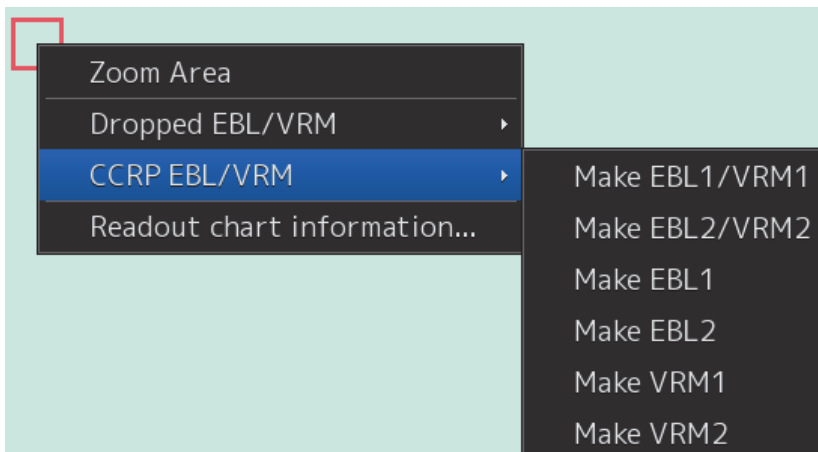

4.5.3.1 Manipulating EBL/VRM with [Dropped EBL/VRM] - [Make EBL1/VRM1] or [Make EBL2/VRM2]

The manipulations of EBL1/VRM1 and EBL2/VRM2 are the same. Here, the manipulation of EBL1/VRM1 is explained as an example.

- 1** Right-click on the screen to display the context menu.

2 Select [Dropped EBL/VRM] - [Make EBL1/VRM1] on the context menu.

EBL1 is displayed and then the measurement starting point appears on the cursor.

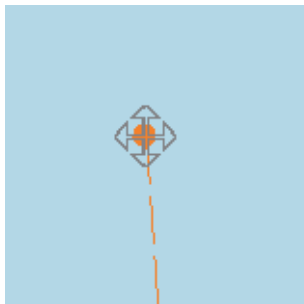

3 Move the cursor and click on at an arbitrary position.

The measurement starting point is fixed.



4 Move the cursor and click on at an arbitrary position.

The EBL1 bearing and the VRM1 range are fixed.

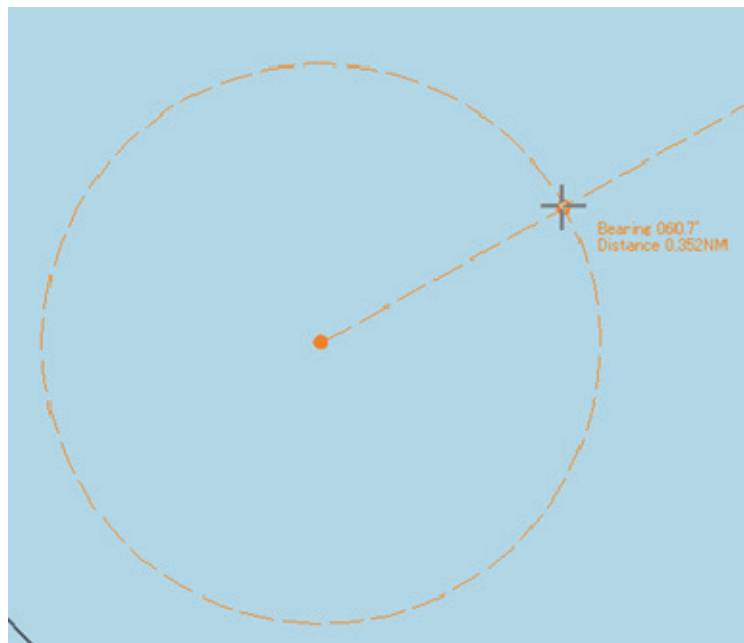

4.5.3.2 Manipulating EBL with [Dropped EBL/VRM] - [Make EBL1] or [Make EBL2]

The manipulations of EBL1 and EBL2 are the same. Here, the manipulation of EBL1 is explained as an example.

- 1 Right-click on the screen to display the context menu.**
- 2 Select [Dropped EBL/VRM] - [Make EBL1] on the context menu.**
EBL1 is displayed and then the measurement starting point appears on the cursor.
- 3 Move the cursor and click on at an arbitrary position.**
The measurement starting point is fixed.
- 4 Move the cursor and click on at an arbitrary position.**
The EBL1 bearing is fixed.

4.5.3.3 Manipulating VRM with [Dropped EBL/VRM] - [Make VRM1] or [Make VRM2]

The manipulations of VRM1 and VRM2 are the same. Here, the manipulation of VRM1 is explained as an example.

- 1 Right-click on the screen to display the context menu.**
- 2 Select [Dropped EBL/VRM] - [Make VRM1] on the context menu.**
VRM1 is displayed and then the measurement starting point appears on the cursor.
- 3 Move the cursor and click on at an arbitrary position.**
The measurement starting point is fixed.
- 4 Move the cursor and click on at an arbitrary position.**
The VRM1 range is fixed.

4.5.3.4 Manipulating EBL/VRM with [Dropped EBL/VRM] - [Move base point of EBL1/VRM1] or [Move base point of EBL2/VRM2]

The manipulations of [Move base point of EBL1/VRM1] and [Move base point of EBL2/VRM2] are the same. Here, the manipulation of [Move base point of EBL1/VRM1] is explained as an example.

- 1 Right-click on the screen to display the context menu.**
- 2 Select [Dropped EBL/VRM] - [Move base point of EBL1/VRM1] on the context menu.**
EBL1 and VRM1 are displayed, and then the measurement starting point appears on the cursor.
- 3 Move the cursor and click on at an arbitrary position.**
The measurement starting point of EBL/VRM is fixed.

4.5.3.5 Manipulating EBL/VRM with [CCRP EBL/VRM] - [Make EBL1/VRM1] or [Make EBL2/VRM2]

The manipulations of EBL1/VRM1 and EBL2/VRM2 are the same. Here, the manipulation of EBL1/VRM1 is explained as an example.

- 1 Right-click on the screen to display the context menu.**
- 2 Select [CCRP EBL/VRM] - [Make EBL1/VRM1] on the context menu.**
EBL1 and VRM1 is displayed, and then the measurement starting point appears on own ship.

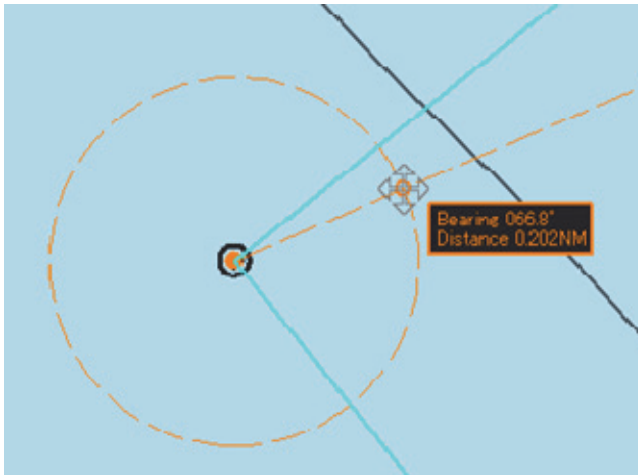

- 3 Move the cursor and click on at an arbitrary position.**
The EBL1 bearing and the VRM1 range are fixed.

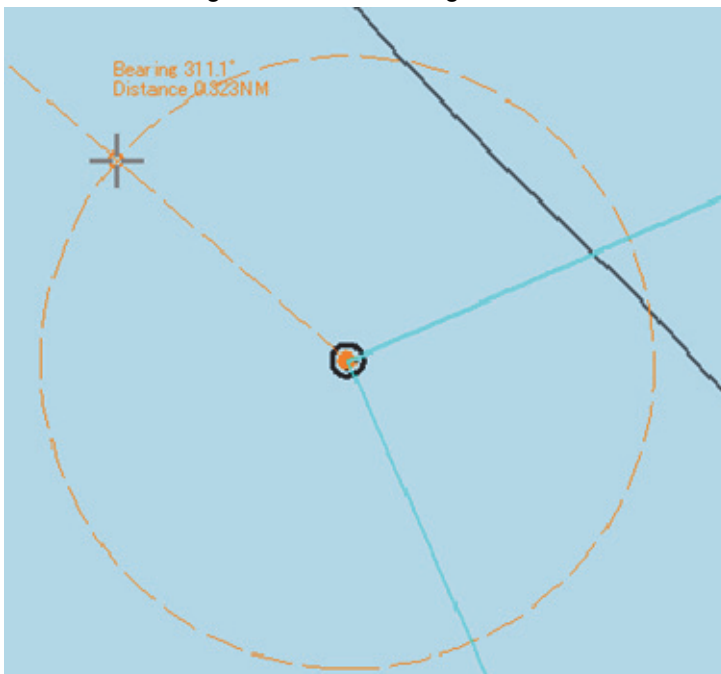

4.5.3.6 Manipulating EBL with [CCRP EBL/VRM] - [Make EBL1] or [Make EBL2]

The manipulations of EBL1 and EBL2 are the same. Here, the manipulation of EBL1 is explained as an example.

- 1 Right-click on the screen to display the context menu.**
- 2 Select [CCRP EBL/VRM] - [Make EBL1] on the context menu.**
EBL1 is displayed, and then the measurement starting point appears on own ship.
- 3 Move the cursor and click on at an arbitrary position.**
The EBL1 bearing is fixed.

4.5.3.7 Manipulating VRM with [CCRP EBL/VRM] - [Make VRM1] or [Make VRM2]

The manipulations of VRM1 and VRM2 are the same. Here, the manipulation of VRM1 is explained as an example.

- 1 Right-click on the screen to display the context menu.**
- 2 Select [CCRP EBL/VRM] - [Make VRM1] on the context menu.**
VRM1 is displayed, and then the measurement starting point appears on own ship.
- 3 Move the cursor and click on at an arbitrary position.**
The VRM1 range is fixed.

4.6 Using Parallel Index Lines (PI)

4.6.1 Description of a parallel index line

Parallel index lines (PI) refer to straight lines at equal interval that are displayed on the screen.

By using parallel index lines, complicated measurement is enabled relating to the bearing and the range by using the own ship's position as the reference point.

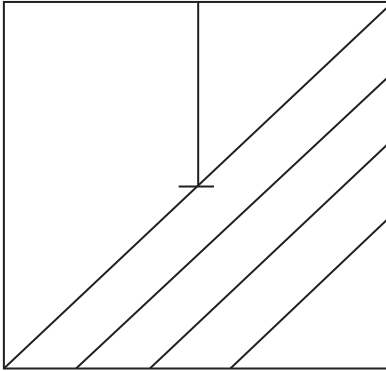

Example of Display

4.6.2 Displaying parallel index lines

4.6.2.1 Displaying parallel index lines in the trackball operation unit

- 1 Click on the [Menu] button on the left toolbar.

The menu is displayed.

- 2 Click on [Tools] - [PI].

The [PI Menu] dialog box appears.

To clear parallel index lines:

- 1 Set the [Display for All Lines] button to Off by clicking on it.

The parallel index lines disappear.

4.6.2.2 Displaying parallel index lines in the keyboard operation unit

1 Press the [PI] key.

Operation when the [PI] key is pressed:

- When the [Display for All Lines] button is set to Off, PI is set to On and the [PI Menu] dialog box is displayed.
- When the [Display for All Lines] button is set to On and the [PI Menu] dialog is displayed, the [PI Menu] dialog is closed. PI remains On.
- When the [Display for All Lines] button is set to On and the [PI Menu] dialog is not displayed, PI is set to Off.

2 Set PI on the [PI Menu] dialog.

For the [PI Menu] dialog, refer to "4.6.2.3 Description of the [PI Menu] dialog". The [PI Menu] dialog setting method varies according to the PI operation mode. For the details, refer to the description of each operation mode, "4.6.3 Setting all the parallel index lines concurrently (All mode)", "4.6.4 Setting parallel index lines individually (Individual mode)", "4.6.5 Displaying lines at equal interval on the left and right sides of the own ship's position (Track mode)", and "4.6.6 Displaying two intersecting lines (Equiangular mode)".

4.6.2.3 Description of the [PI Menu] dialog

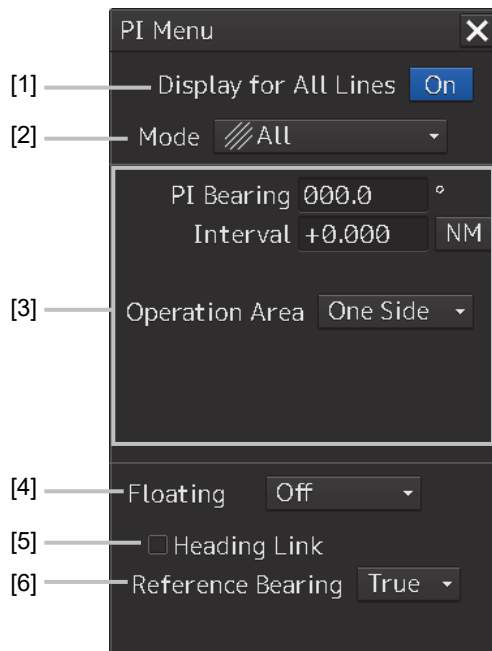

Note

The parallel index line cursor can be operated with the EBL/VRM dial of the keyboard operation unit only when the [PI Menu] dialog is displayed. Even if the dialog is closed, the parallel index lines remain displayed, however, the bearing and interval cannot be operated. To reset the bearing and the interval, set by redisplaying the [PI Menu] dialog.

[1] [Display for All Lines] (Display for all PI lines) button

Use this button to switch display for all PI lines to ON/OFF.

The button ON/OFF state is maintained even if the dialog box is closed.

The parallel index lines that are displayed by setting the [Display for All Lines] button to On are those that are selected on the [View-Options] dialog that is displayed by selecting [View] - [Options] - [Tools] on the menu.

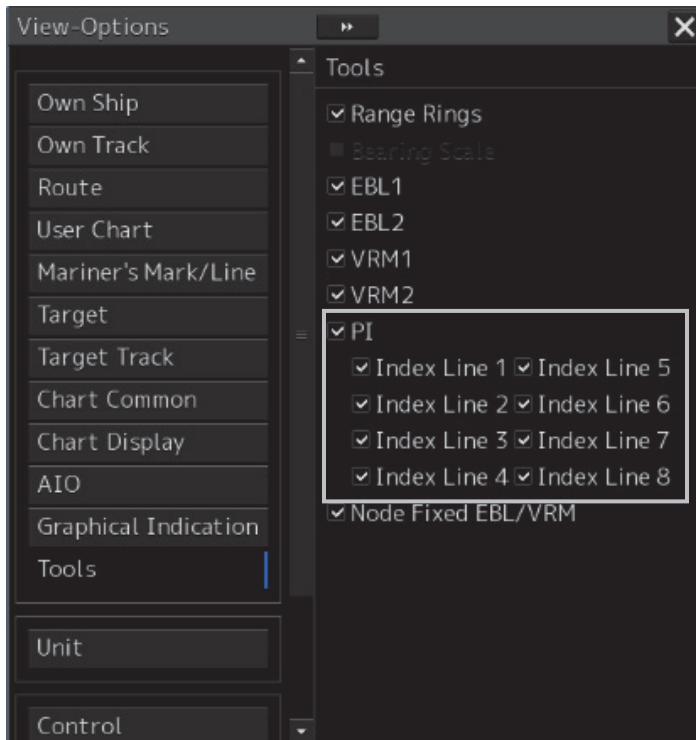

- When the operation mode is Individual and the [Display for All Lines] button is set to On, the parallel index lines that were selected in the [View-Options] dialog (Index Line 1 to Index Line 8) are displayed on the screen.
- When the operation mode is Track or Equiangular and the [Display for All Lines] button is set to On, the parallel index lines that were selected in the [View-Options] dialog (Index Lines 1, 3, 5, and 7 correspond to groups 1, 2, 3, and 4 respectively) are displayed.
- When the operation mode is All, the line at the center of the screen becomes Index Line1 and the parallel lines from the center to the outer section correspond to Index Line2, 3.... When [Operation Area] is set to [Both Side], the parallel index lines forming pairs on opposite sides with each other based on Index Line1 correspond to Index Line2, 3... towards the outer section.

[2] [Mode] (operation mode switching) combo box

Select an operation mode.

When the operation mode is selected, the dialog box of the selected operation mode is displayed.

For the details of the operation mode, refer to "4.6.3 Setting all the parallel index lines concurrently (All mode)", "4.6.4 Setting parallel index lines individually (Individual mode)", "4.6.5 Displaying lines at equal interval on the left and right sides of the own ship's position (Track mode)" and "4.6.6 Displaying two intersecting lines (Equiangular mode)".

[3] Parameter setting area by operation mode

Set parameters in each operation mode.

The settings differ depending on the operating mode.

Refer to "4.6.3 Setting all the parallel index lines concurrently (All mode)", "4.6.4 Setting parallel index lines individually (Individual mode)", "4.6.5 Displaying lines at equal interval on the left and right sides of the own ship's position (Track mode)" and "4.6.6 Displaying two intersecting lines (Equiangular mode)".

[4] [Floating] combo box

Move the center of the parallel index line.

Select the Floating mode from the list.

- [Off]: Sets the starting point of the parallel index line to the CCRP position.
- [Screen Fix]: Moves the center of the parallel index line and fixes it on the screen.
- [L/L Fix]: Moves the center of the parallel index line and fixes it based on the latitude and longitude.
(Connection of a navigation unit is required.)

[5] [Heading Link] (Heading link setting)

Set whether the parallel index line is linked to the ship's heading.

- When this item is checked, the parallel index line is linked to the ship's heading.
- When this item is unchecked, the parallel index line is not linked to the ship's heading.

Different values can be set for the angle of the parallel index lines when this item is checked and the angle of the parallel index lines when the item is unchecked.

[6] [Reference Bearing] (Reference bearing selection)

Set a reference bearing of the bearing value display of the parallel index line.

- [True]: Displays in true bearing (based on the North).
- HL: Displays in the heading line reference.
- Index Line 1 to Index Line 8: Displays by using the Index Line as the reference. (Only when the operation mode is "Individual")
- Group 1 to Group 4: Displays by using the Group as the reference. (Only when the operation mode is "Track")

Memo

[Reference Bearing] (reference bearing selection) is not displayed in Equiangular mode as the operation mode.

Switching the Floating mode

When [Screen Fix] or [L/L Fix] is selected in switching the Floating mode, the cursor mode changes.

- When the screen is clicked on, the fixed position or the coordinates on the screen are determined, and the cursor is changed to the normal cursor.
- When [Screen Fix] or [L/L Fix] is re-selected after the determination, the cursor changes to the center selection cursor for parallel index lines.

4.6.3 Setting all the parallel index lines concurrently (All mode)

When the operation mode is set to [All], all the parallel index lines are operated concurrently. All the lines are in parallel.

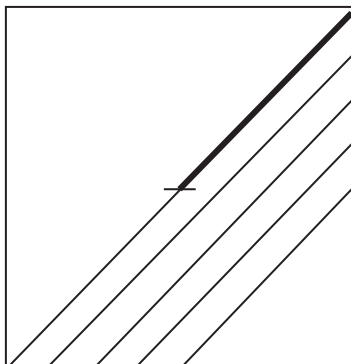

Display Example

- 1 Select [All] from the [Mode](operation mode) combo box.

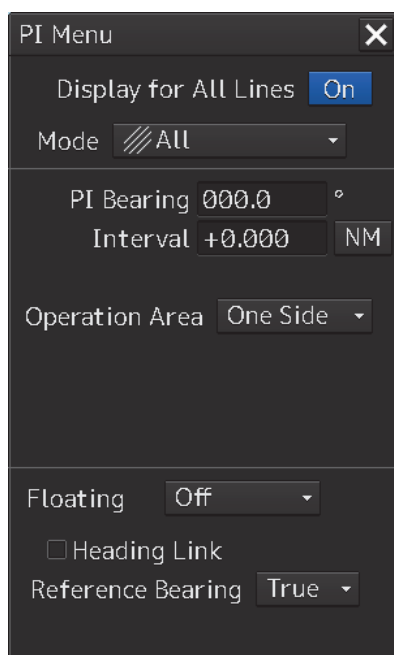

- 2 Enter a direction of the parallel index lines in [PI Bearing] (parallel index line bearing adjustment).

The setting is applied to the bearings of all the parallel index lines.

Memo

The bearing can also be adjusted by turning the [EBL] dial clockwise/counterclockwise. When the dial is turned clockwise, the bearing is adjusted in the plus direction, and when the dial is turned counterclockwise, the bearing is adjusted in the minus direction. The set value is displayed in the input box.

3 Enter a display interval of the parallel index lines in [Interval] (parallel index line interval adjustment).

The setting is applied to all the lines.

The input range is the diagonal length of the screen

Memo

The bearing can also be adjusted by turning the [VRM] dial clockwise/counterclockwise. When the dial is turned clockwise, the bearing is adjusted in the plus direction and when the dial is turned counterclockwise, the bearing is adjusted in the minus direction. The set value is displayed in the input box.

Whenever the unit display switching button on the right side of [Interval] is clicked on, the unit (NM/km/sm) of the value displayed is switched.

Memo

NM denotes nautical mile, sm denotes statute mile, and km denotes kilometer.

4 Select the area for displaying the parallel index line from the [Operation Area] (operation area selection) combo box.

When [One Side] is selected, 8 parallel index lines are displayed on one side of the reference point of own ship or the point set arbitrarily.

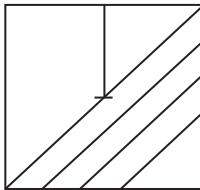

When [Both Side] is selected, 15 parallel index lines are displayed on both sides of the reference point of own ship or the point set arbitrarily.

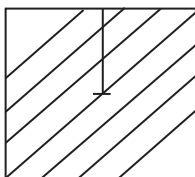

4.6.3.1 Changing the bearing/interval of parallel index lines in the trackball operation unit (All mode)

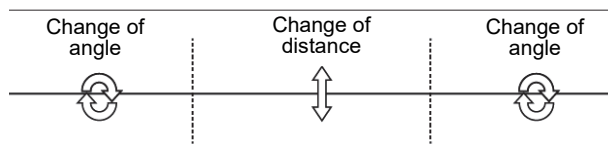
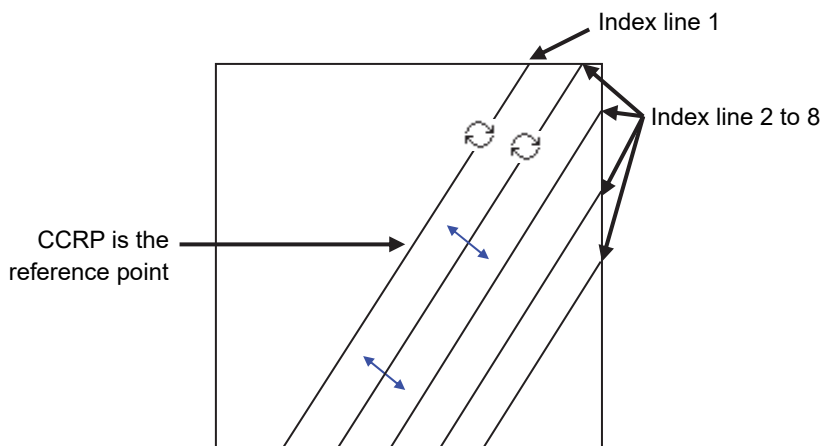

Dividing the line segment that can be clicked into 3 equal sections

[Changing the bearing with index line 1]

When index line 1 is clicked on, the shape of the cursor changes to .

All the index lines rotate centering on the index line reference position (starting point).

[Changing the bearing at a clickable trisectional end segment position of index lines 2 to 8]

When one of the index lines 2 to 8 is divided into three equal segments and the mouse button is clicked on both ends of the line segments, the cursor shape changes to .

Index lines 2 to 8 move, forming a circle centering on the reference position while the index line reference position (starting point) is fixed.

[Changing the interval at a clickable trisectional center segment position of index lines 2 to 8]

When one of the index lines 2 to 8 is divided into three equal segments and the mouse button is clicked on the middle line segments, the cursor shape changes to .

Index lines 2 to 8 move in parallel to index line 1.

Memo

If a clickable segment is 2 cm or less, the change of interval mode is always activated.

4.6.4 Setting parallel index lines individually (Individual mode)

By setting the operation mode to [Individual], the bearing and the interval of parallel index lines can be set individually.

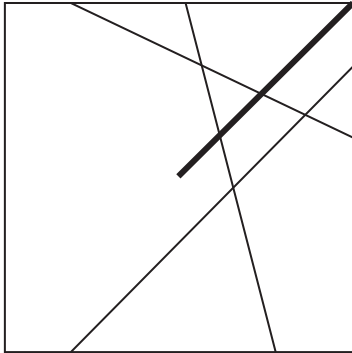

Display Example

- 1 Select [Individual] from the [Mode] (operation mode) combo box.

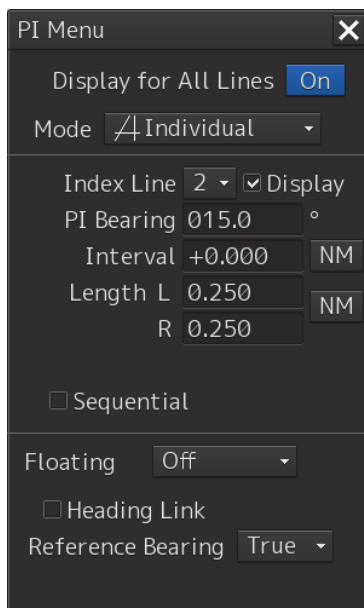

- 2 Select a parallel index line (1 to 8) to be set from the [Index Line] (parallel index line selection) combo box
- 3 Select [Display].
The selected parallel index line is displayed.
- 4 Enter the bearing of the parallel index line in [PI Bearing] (parallel index line bearing adjustment).

Memo

The bearing can also be adjusted by turning the [EBL] dial clockwise/counterclockwise. When the dial is turned clockwise, the bearing is adjusted in the plus direction, and when the dial is turned counterclockwise, the bearing is adjusted in the minus direction. The set value is displayed in the input box.

5 Enter the interval of the parallel index line in [Interval] (parallel index line interval adjustment).

The input range is the diagonal length of the screen

Memo

The interval can also be adjusted by turning the [VRM] dial to the left/right. The interval can be increased by turning the dial to the right and the interval can be reduced by turning the dial to the left. The set value is displayed in the input box.

Whenever the unit display switching button on the right side of [Interval] is clicked on, the unit (NM/km/sm) of the numeric value that is displayed is switched.

Memo

NM denotes nautical mile, sm denotes statute mile, and km denotes kilometer.

6 Set [Length] (adjustment of parallel index line length).

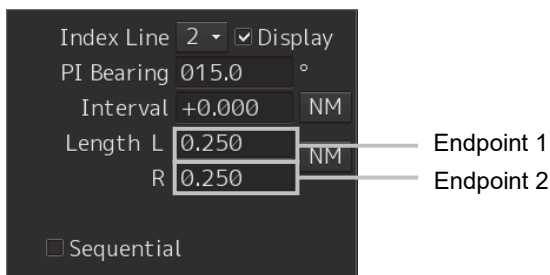

Adjust the length of the parallel index line by changing the positions of endpoint 1 and endpoint 2.

- Define endpoint 1 as the point on the left side when PI center is viewed from the own ship and endpoint 2 as the point on the right side.

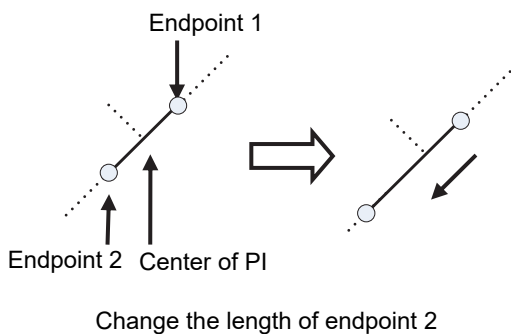

- Set the mode to the endpoint change mode by pressing the [VRM] dial and turn the [VRM] dial to change the position of an endpoint.

Clockwise: + (Direction from the center of PI to outside)

Counterclockwise: - (Direction towards the center of PI)

The input range is as follows.

- The minimum length of a parallel index line from the left end to the right end is 2 cm.
- The maximum length is the diagonal line of the screen.

Memo

A negative value can also be set for Length.

- In the case of the left end, the left direction from the center becomes a positive value and the right direction from the center becomes a negative value.
- In the case of the right end, the right direction from the center becomes a positive value and the left direction from the center becomes a negative value.

Whenever the unit display switching button on the right side of [length] is clicked on, the unit (NM/km/sm) of the numeric value that is displayed is switched.

Memo

NM denotes nautical mile, sm denotes statute mile, and km denotes kilometer.

Setting parallel index lines consecutively

When [Sequential] is checked and [Screen Fix] or [L/L Fix] is selected at floating mode switching, the parallel index lines to be set are changed in the sequence of Index Line1→2→...→8→1... and setting can be performed consecutively.

Note

The index lines that are set to be hidden by selecting [View] - [Options] - [Tools] on the menu are skipped during operation.

4.6.4.1 Changing the bearing/interval/end point of parallel index lines in the trackball operation unit (Individual mode)

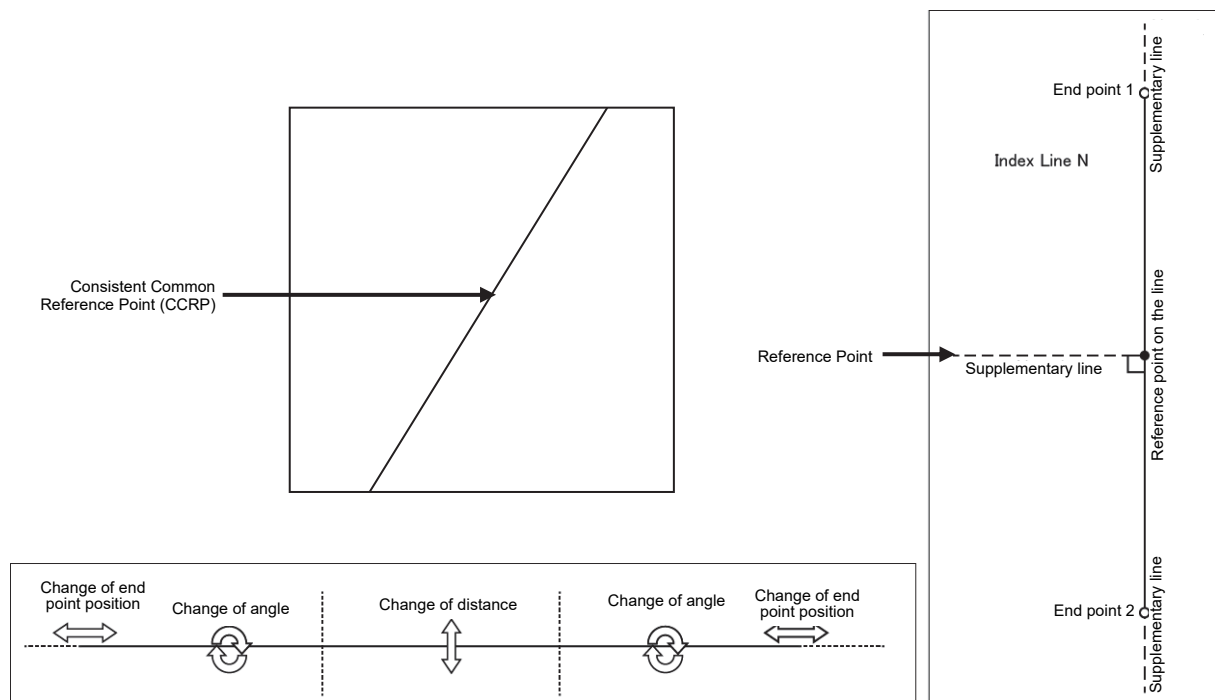

Dividing the line segment that can be clicked into 3 equal sections

End points 1 and 2

[Changing the bearing at a clickable trisectional segment position on both sides]

- 1 Place the cursor on the lines on both sides of the lines that were created by dividing one of the index lines 1 to 8, which can be clicked, into 3 equal sections and click the button.**

The shape of the cursor changes to  and when the mouse button is clicked, the bearing of the parallel index lines can be changed.

- 2 Move the cursor to the bearing to be set.**

The bearing of the parallel index lines changes together with the cursor.

- 3 Click the mouse button.**

The parallel index lines are fixed.

[Changing the distance at a clickable trisectional middle position]

- 1 Place the cursor on the middle line of the lines that were created by dividing one of the index lines 1 to 8, which can be clicked, into 3 equal sections and click the button.**
The shape of the cursor changes to  and when the mouse button is clicked, the interval of the parallel index lines can be changed.
- 2 Move the cursor to the interval to be set.**
The interval of the parallel index lines changes together with the cursor.
- 3 Click the mouse button.**
The parallel index lines are fixed.

Memo

If a clickable segment is 2 cm or less, the change of interval mode is always activated.

[Changing the positions of end points 1 and 2]

- 1 Set the cursor on the broken-line display section on the end point side to be moved on one of the index lines 1 to 8.**
The shape of the cursor changes to  and when the mouse button is clicked, the position of end point 1 or end point 2 can be changed.
- 2 Move the cursor to the bearing to be set.**
The position of end point 1 or 2 changes together with the cursor.
- 3 Click the mouse button.**
The position of end point 1 or 2 is fixed.

4.6.5 Displaying lines at equal interval on the left and right sides of the own ship's position (Track mode)

When the operation mode is set to [Track], lines are displayed on both the left and right sides at equal intervals.

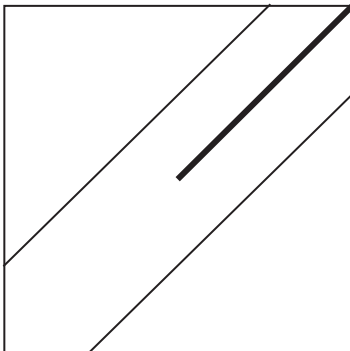

Display Example

1 Select [Track] from the [Mode] (operation mode) combo box.

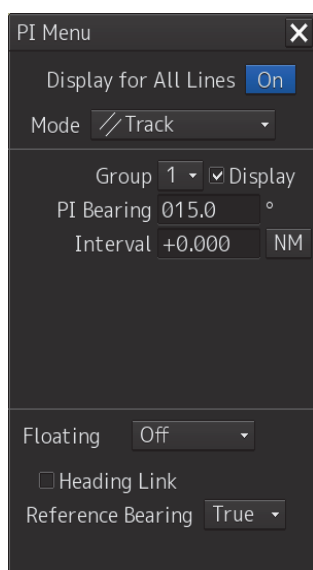

2 Select a parallel line cursor group (1 to 4) from the [Group] (parallel line cursor group) combo box.

Since in [Track] mode, parallel index lines always form pairs, set in group units.

3 Select [Display].

The selected parallel index line is displayed.

4 Enter the bearing of the parallel index line group in [PI Bearing] (parallel index line bearing adjustment).

Memo

The bearing can also be adjusted by turning the [EBL] dial clockwise/counterclockwise. When the dial is turned clockwise, the bearing is adjusted in the plus direction, and when the dial is turned counterclockwise, the bearing is adjusted in the minus direction. The set value is displayed in the input box.

5 Enter the interval of the parallel index line group in [Interval] (parallel index line group interval adjustment).

The maximum length is the diagonal line of the screen.

Memo

The bearing can also be adjusted by turning the [VRM] dial clockwise/counterclockwise. When the dial is turned clockwise, the bearing is adjusted in the plus direction and when the dial is turned anti-clockwise, the bearing is adjusted in the minus direction. The set value is displayed in the input box.

Whenever the unit display switching button on the right side of [Interval] is clicked on, the unit (NM/km/sm) of the numeric value that is displayed is switched.

Memo

NM denotes nautical mile, sm denotes statute mile, and km denotes kilometer.

4.6.5.1 Changing the bearing/interval of parallel index lines with the trackball (Track mode)

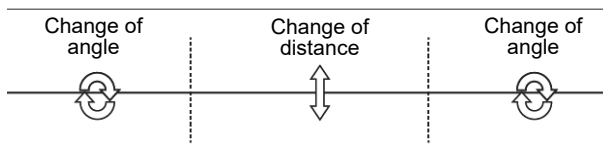
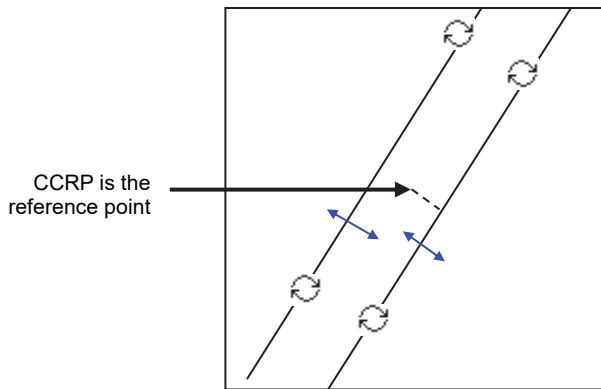

Dividing the line segment that can be clicked into 3 equal sections

[Changing the bearing at a clickable trisectional end segment position]

- 1 Place the cursor on the lines on both sides of the lines that were created by dividing one of the index lines 1 to 8, which can be clicked, into 3 equal sections and click the button.**
The shape of the cursor changes to  and when the mouse button is clicked, the bearing of the parallel index lines can be changed.
- 2 Move the cursor to the bearing to be set.**
The bearing of the parallel index lines changes together with the cursor.
- 3 Click the mouse button.**
The parallel index lines are fixed.

[Changing the distance at a clickable trisectional middle position]

- 1 Place the cursor on the middle line of the lines that were created by dividing one of the index lines 1 to 8, which can be clicked, into 3 equal sections and click the button.**
The shape of the cursor changes to  and when the mouse button is clicked, the interval of the parallel index lines can be changed.
- 2 Move the cursor to the interval to be set.**
The interval of the parallel index lines changes together with the cursor.
- 3 Click the mouse button.**
The parallel index lines are fixed.

4.6.6 Displaying two intersecting lines (Equiangular mode)

When the operation mode is set to [Equiangular], two intersecting lines are displayed.

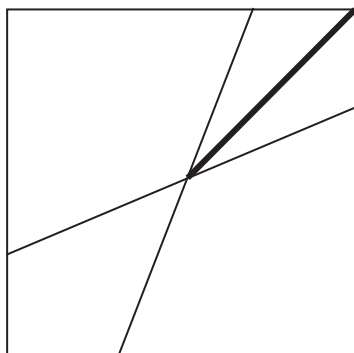

Display Example

- 1 Select [Equiangular] from the [Mode] (operation mode) combo box.

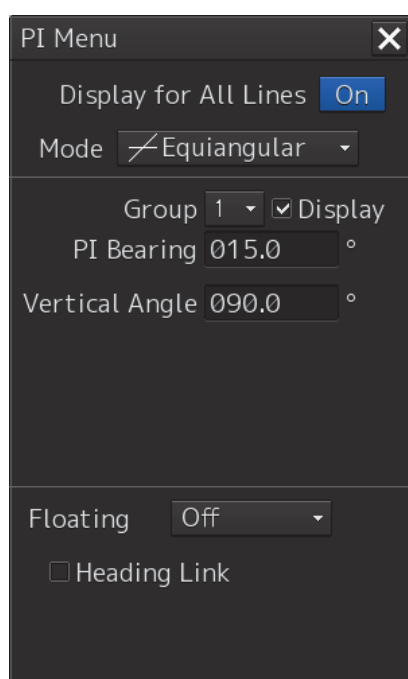

- 2 Select a parallel index line group (1 to 4) from the [Group] (parallel index line group).
Since parallel index lines form pairs in [Equiangular] mode, set in group units.
- 3 Select [Display].
The selected parallel line cursor group is displayed.

- 4** Enter the bearing of the parallel index line group in [PI Bearing] (parallel index line bearing adjustment).

Memo

The bearing can also be adjusted by turning the [EBL] dial clockwise/counterclockwise. When the dial is turned clockwise, the bearing is adjusted in the plus direction, and when the dial is turned counterclockwise, the bearing is adjusted in the minus direction. The set value is displayed in the input box.

- 5** Enter the vertical angle of the parallel index line group in [Vertical angle] (parallel index line vertical angle adjustment).

4.6.6.1 Changing the bearing of two intersecting lines in the trackball operation unit (Equiangular mode)

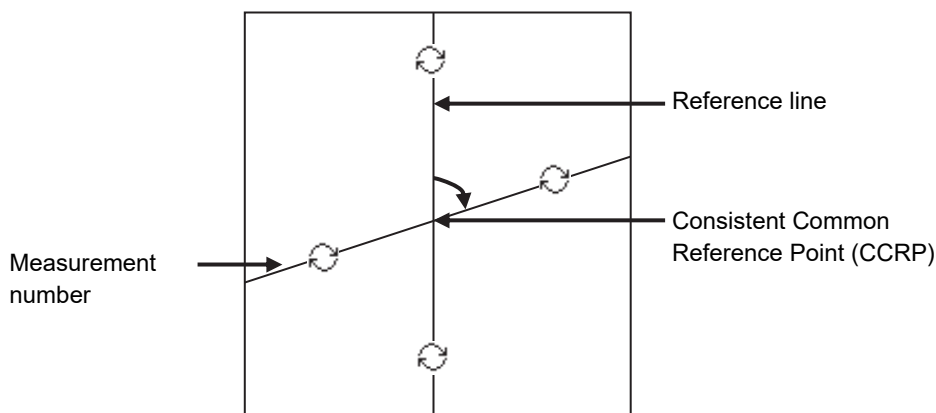

[Changing the bearing of index lines 1 to 8]

- 1** Place the cursor on index lines 1 to 8 and click the mouse button.
The shape of the cursor changes to  and when the mouse button is clicked, the bearing of the two intersecting lines can be changed.
- 2** Move the cursor to the bearing to be set.
The bearing of the two intersecting lines changes together with the cursor.
- 3** Click the mouse button.
The two intersecting lines are fixed.

4.6.7 Setting parallel index lines in the keyboard operation unit

The bearing and interval of parallel index lines can be set with the [EBL] and [VRM] dials.

- 1 Press the [PI] key to display the [PI Menu] dialog box.**
- 2 By turning the [EBL] dial, set up bearing.**
Turning the [EBL] dial to the right changes the bearing of parallel index lines in the right bearing [1] and turning it to the left changes in the left bearing [2].
- 3 By turning the [VRM] dial, set up the interval of parallel index lines.**
Turning the [VRM] dial to the left narrows the interval of parallel index lines [3] and turning it to the right widens the interval [4].

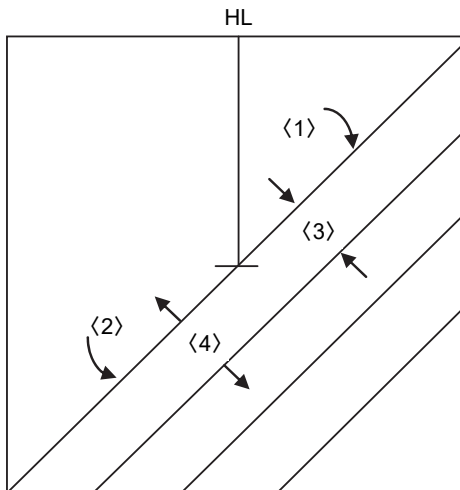

- 4 Press the [PI] key to close the [PI Menu] dialog box.**
The parallel index lines are fixed.

The operation and motion of the parallel index differ depending on the motion mode in the [PI Menu] dialog.

4.6.7.1 Operation in All mode

[Operating the [EBL] dial]

By using the [EBL] dial, the bearing of the index lines can be changed.

[Operating the [VRM] dial]

By using the [VRM] dial, the interval of the index lines can be changed.

4.6.7.2 Operation in Individual mode

In Individual mode, the index line that is selected in the [Index Line] combo box is operated.

[Using the [EBL] dial]

By using the [EBL] dial, the bearing of the index line can be changed.

Setting parallel index lines consecutively by using the [EBL] dial

When [Sequential] is checked, the floating mode is set. When [Screen Fix] or [L/L Fix] is selected, the parallel index line to be set is switched in the sequence of Index Line1→2→...→8→1..., enabling consecutive setting.

Note
The index lines that are set to be hidden by selecting [View] - [Options] - [Tools] on the menu are skipped during operation.

[Operating the [VRM] dial]

By using the [VRM] dial, the interval of the index lines can be changed.

The reference point for changing the interval can be an end point 1 or 2 of the index line or the reference point on the line.

Whenever the [VRM] dial is pressed, the reference point is selected in the sequence of "end point 1→end point 2→reference point on the line→..."

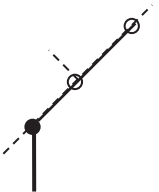
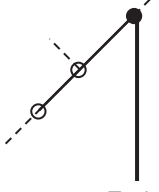
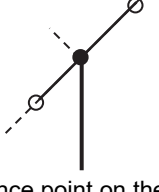
End point 1	End point 2	Reference point on the line
 <p>End point 1</p>	 <p>End point 2</p>	 <p>Reference point on the line</p>
As a result of the selection, the distance from the reference point to the end point 1 on the line changes.	As a result of the selection, the distance from the reference point to the end point 2 on the line changes.	As a result of selection, the interval from the reference point to the index line changes.

4.6.7.3 Operation in Track mode

The index lines of the group that is selected in [Group] combo box are operated in Track mode.

[Operating the [EBL] dial]

By using the [EBL] dial, the bearing of the index lines can be changed.

[Operating the [VRM] dial]

By using the [VRM] dial, the interval of the index lines can be changed.

4.6.7.4 Operation in Equiangular mode

The index lines of the group that is selected in [Group] combo box are operated in Equiangular mode.

[Operating the [EBL] dial]

By pressing the [EBL] dial, the "Group reference line (PI Bearing)" and the "Group measurement line" can be set.

Whenever the [EBL] dial is pressed, the "Group reference line (PI Bearing)" and the "Group measurement line" are selected alternately.

Memo

A measurement line can be set across the reference line. (When a measurement line is set across the reference line by rotating the dial in the minus direction, the measured bearing data changes as $0^{\circ} \rightarrow 359.9^{\circ}$.)

When the reference line is set by using the EBL dial, the value of the measured bearing data is maintained and the measurement line follows concurrently.

[Operation the [VRM] dial]

In Equiangular mode, the [VRM] dial is disabled.

4.7 Using the EBL Maneuver

The EBL Maneuver is the function that displays a predictable track when own ship is turned under certain conditions.

By displaying a maneuver curve that has been drawn by taking safety into consideration, it can be used as the guideline for turning.

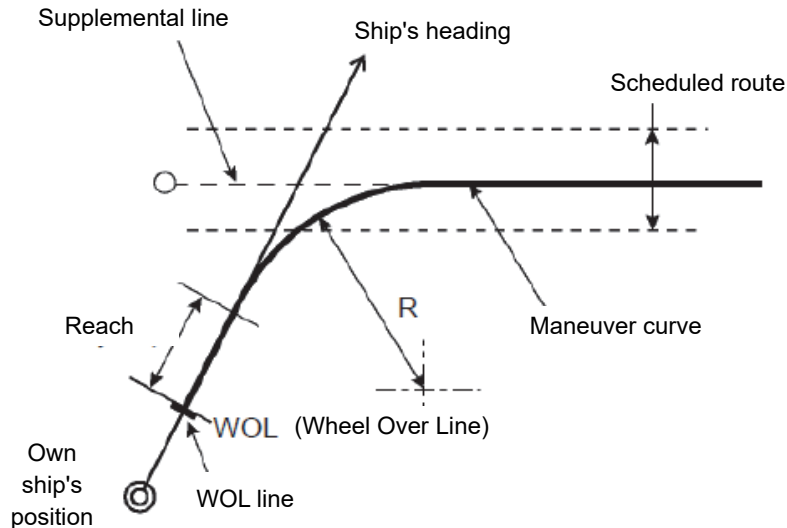

4.7.1 Displaying the [EBL Manoeuvre Setting] dialog box

- 1** Click on the [Menu] bar on the left toolbar.
The menu is displayed.
- 2** Click on the [Tools] - [EBL Manoeuvre] button on the menu.
The [EBL Manoeuvre Setting] dialog box appears.



4.7.2 Clearing the display of maneuver curve

1 Click on the [Display Manoeuvre curve] button.

The [Display Manoeuvre curve] button display is set to [OFF] and the maneuver curve is cleared from the screen.

4.7.3 Setting the creation conditions of the EBL Maneuver

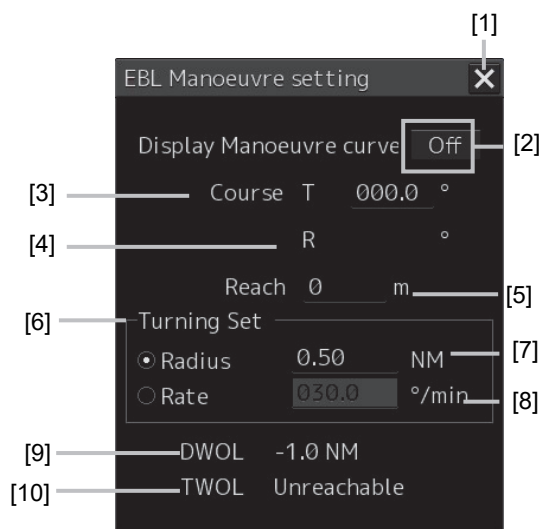

[1] [X] button

Use this button to close the [EBL Manoeuvre] dialog box.

[2] [Display Maneuver curve] (Maneuver curve display) button

When this button is set to ON, the cursor mode changes to the maneuver curve creation mode.

[3] [Course T] (Bearing of the acquisition line (true bearing))

The bearing of the acquisition line is displayed in true bearing. The line can also be set.

The input range is from 0.0 to 359.9°.

[4] [Course R] (Bearing of the acquisition line (relative bearing))

The bearing of the acquisition line is displayed in relative bearing.

[5] [Reach] (Distance from steering to turning)

The distance (reach) from steering to turning is displayed. The line can also be set.

The input range is from 0 to 2000 m (integer value).

[6] [Turning Set] (Turning mode)

Select a turning mode from either [Radius] (constant turn radius) or [Rate] (constant turn rate).

[7] [Radius] (Constant turn radius)

Set a constant turn radius to be used for the Radius turn mode.

The input range is from 0.10 to 9.99NM.

[8] [Rate] (Constant turn rate)

Set a constant turn speed to be used in Rate turn mode.

The input range is from 20.0 to 720°/min.

[9] [DWOL] (Distance to WOL)

The distance up to WOL is displayed.

[10] [TWOL] (Expected traveling time to reach WOL)

The expected traveling time to reach WOL is displayed.

When the ship's speed is 0 or the speed information of the own ship is invalid and the TWOL value is invalid, "***h**m**s" is displayed.

4.7.4 Creating an EBL manoeuvre curve

- 1 Set the function to [ON] by clicking on the [Display Manoeuvre curve] (EBL maneuver curve) button.

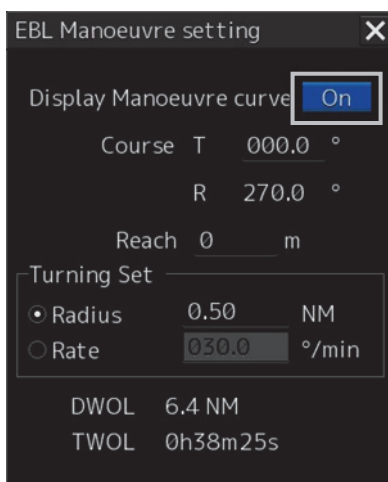

A supplemental line, a manoeuvre curve, and a WOL for creating a manoeuvre curve are displayed and the manoeuvre curve creation mode is set.

The bearing of the supplementary line can be changed by turning the EBL dial during creation of a manoeuvre curve.

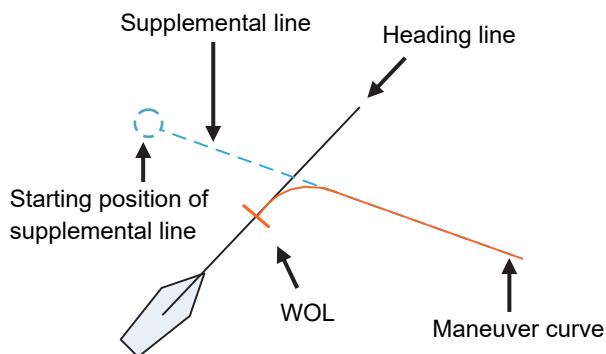

2 Determine a supplemental line starting position by clicking.

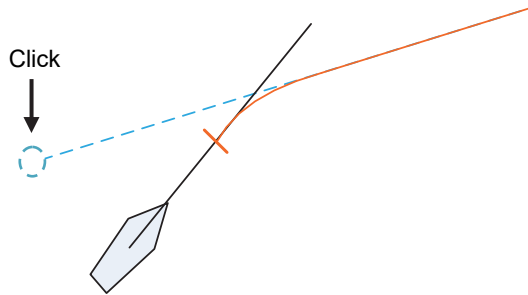

Note

When the WOL position is behind the own ship, the color of WOL changes to red and the supplemental line starting point can no longer be determined by clicking on the point.

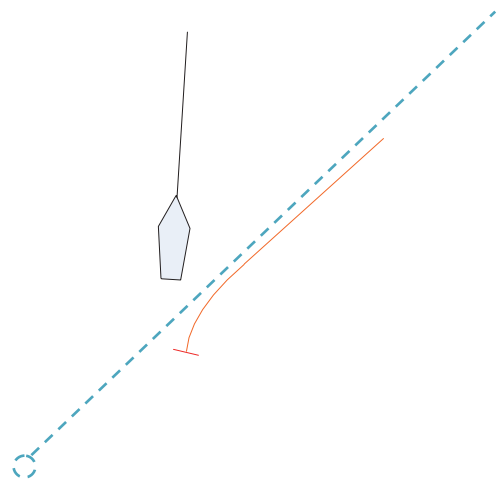

Cancelling the creation of maneuver curve

By clicking the right-button in maneuver curve creation mode, the creation can be cancelled.

4.8 Connecting Own Ship and the Specified Fixed Position with EBL and the VRM Marker (Node Fixed EBL/VRM Function)

Node Fixed EBL-VRM is the function that connects the own ship with the specified fixed position with the EBL and VRM markers.

Since this EBL/VRM connection is maintained even if the own ship travels, it is possible to always know the bearing and distance of the own ship against the fixed position.

On the selected fixed position, the bearing and distance of the own ship against the fixed position are displayed.

4.8.1 Displaying the [Node Fixed EBL/VRM] dialog box

To execute the Node Fixed EBL/VRM function, the [Node Fixed EBL/VRM] dialog box must be displayed.

- 1 Click on the [Menu] button on the left toolbar.**
A submenu is displayed.
- 2 Click on the [Node Fixed EBL/VRM] button on the menu.**
The [Node Fixed EBL/VRM] dialog box appears.



4.8.2 Description of [Node Fixed EBL/VRM] dialog box

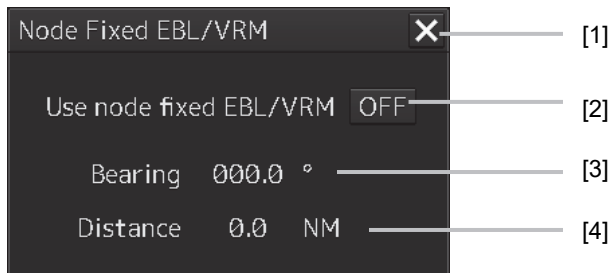

[1] [x] button

When the [x] button is clicked on, the [Node Fixed EBL/VRM] dialog box is closed.

[2] [Use Node Fixed EBL/VRM] button

This button sets the display of fixed position EBL/VRM to ON/OFF.

[ON]: The cursor mode is changed to the EBL/VRM marker intersection move mode.

[OFF]: Cancels the fixed position EBL/VRM display.

[3] Bearing up to the fixed position

Displays the bearing from the own ship to the fixed position.

The bearing is always reflected.

[4] Distance up to the fixed position

Displays the distance from the own ship to the fixed position.

The distance is always reflected.

4.8.3 Creating a new Node Fixed EBL/VRM

- 1 Set the function to ON by clicking on the [Use Node Fixed EBL/VRM] button.

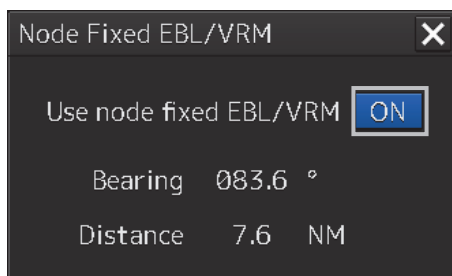

The cursor mode is set to the EBL/VRM marker intersection move mode.

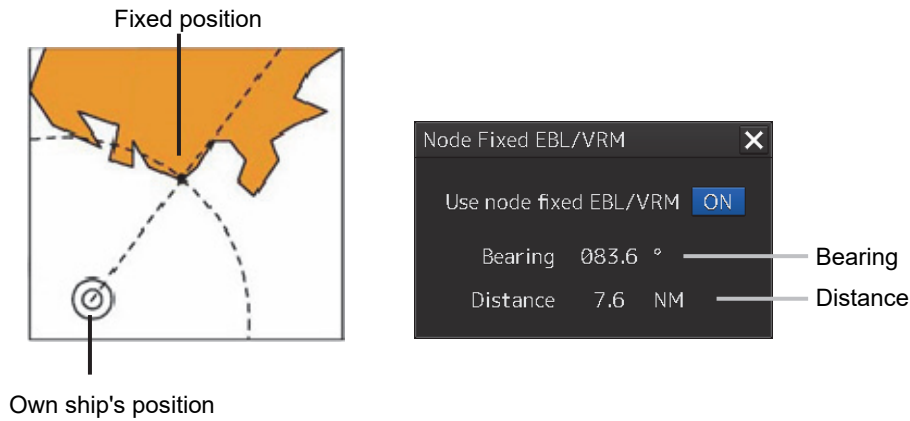

2 Determine the fixed position by clicking the position to be fixed.

The bearing and distance of the own ship against the fixed position are displayed on the selected fixed position and these values change as the own ship advances.

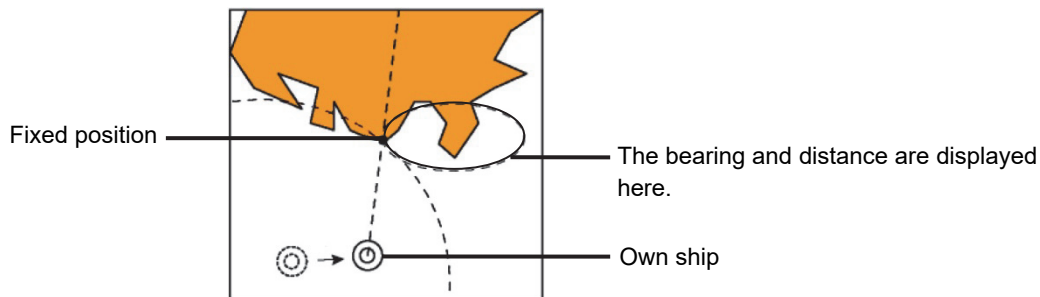

[Relationship between the own ship and the fixed position when the own ship advances]

Even if the [Node Fixed EBL/VRM] dialog box is closed after the fixed position is determined, the display of Node Fixed EBL/VRM remains.

After the fixed position is determined, the cursor mode changes to the AUTO mode (If the mode prior to the Node Fixed EBL/VRM new creation is an eraser tool mode, the mode changes to the eraser tool mode after the fixed position is determined).

When the mouse button is clicked on any position in Node Fixed EBL/VRM in AUTO mode, the mode changes to the Node Fixed EBL/VRM intersection shift mode.

4.8.4 Cancelling the Node Fixed EBL/VRM function

1 Click the right mouse button in Node Fixed EBL/VRM intersection shift mode.

The mode is cancelled and the [Use Node Fixed EBL/VRM] button is set to OFF.

4.9 Measuring the Own Ship's Position Manually (LOPs Fixing Function of Manual position fix)

This function is used for measuring the own ship's position based on the following navigation and plotting on the chart by using LOP (Line Of Position).

The own ship's position can also be jumped to the plotted position.

The default setting for "LOP source indication" is "Off".

4.9.1 Displaying the [Manual Position Fix] dialog box

- 1 Click on the [Menu] button on the left toolbar.**
The menu is displayed.
- 2 Click on the [Tools] - [Manual Position Fix] button on the menu.**
The [Manual Position Fix] dialog box appears.

Manual Position Fix

LOPs Fixing | Position Offset

LOP 1 (Total: 5,MAX:10)

Observations Time

Date 2023-09-20 31

Time 04:52:31 (UTC)

Position 38°50.380'S

(e.g. landmark) 14°58.790'E

Bearing 345.0 °

Distance 0.000 NM

Transfer Position line

HDG/STW COG/SOG

HDG 000.0 ° Set 000.0 °

STW 10.0 kn DRIFT 10.0 kn

Set Delete

Plot Plot by Cursor

Clear all lines

4.9.2 Description of the [LOPs Fixing] tab of the [Manual Position Fix] dialog box

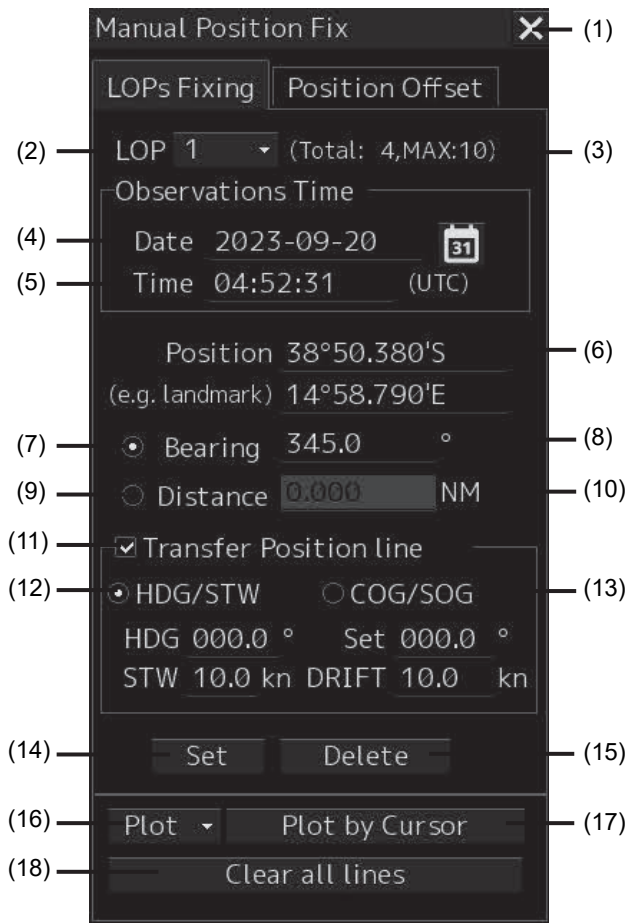

[1] [X] button

Use this button to close the [Manual Position Fix] dialog box.

[2] [LOP] (LOP selection combo box)

When a LOP number (1 to 10) is selected from the list, the LOP is switched to the generated LOP corresponding to the number.

[3] Display of the number of LOPs

The maximum number of LOPs that can be created and the number of LOPs that have been created are displayed.

[4] [Date] (Observation date)

When the text box is clicked on, a calendar picker is displayed, enabling input of an observation date.

[5] [Time] (Observation time)

When the text box is clicked on, a calendar picker is displayed, enabling input of an observation time.

[6] [Position] (LOP reference point)

Set a reference point by entering a LOP reference point through the software keyboard or clicking on any position on the chart.

Memo

The maximum latitude input range of Position is 85 ° 00.000 (polar range restriction).

[7] [Bearing] (Selection of LOP bearing mode)

When this item is selected, LOP is switched to the bearing mode.

[8] LOP bearing input box

Enter a bearing of LOP. The input is enabled when LOP is in bearing mode.

[9] [Distance] (Selection of LOP distance mode)

When this item is selected, LOP is switched to the distance mode.

[10] LOP distance input box

Enter a distance of LOP. The input is enabled when LOP is in distance mode.

[11] [Transfer Position Line] (TPL ON/OFF)

When this item is checked, TPL (Transfer Position Line) is drawn by determining the transfer amount from the observation time differences of all other LOPs, the bearing and speed of the ship and the current direction and the current speed. However, transfer does not occur to the past LOP.

[12] [HDG/STW] (Selection of speed through water)

When this item is selected, TPL is determined from the speed through water, the current direction, and the current speed.

This item can be selected when [Transfer Position Line] is checked.

[13] [COG/SOG] (Selection of speed over the ground)

When this item is selected, TPL is determined from the speed over the ground.

This item can be selected when [Transfer Position Line] is checked.

[14] [Set] button

When this item is clicked on, the LOP that was created is determined and control is passed to the next LOP creation mode.

[15] [Delete] button

When this button is clicked on, the LOP that was selected on the LOP selection combo box is deleted.

[16] [Plot] button

When this button is clicked on, the following menu is displayed.

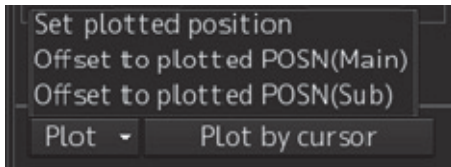

- [Set plotted position]: Creates a reference point on the plotted position on the chart.
- [Offset to plotted POSN(Main)]: Creates a reference point on the position determined by offsetting from plotted position by POSN.
- [Offset to plotted POSN(Sub)]: Creates a reference point on the position determined by offsetting from plotted position by POSN.

[17] [Plot by cursor] button

When the mouse button is clicked on this button, the cursor shape changes to the offset cursor, enabling creation of a Plotted Position on the coordinates on which the button was clicked with the offset cursor.

[18] [Clear all lines] button

When this button is clicked, all the LOPs that were created are deleted.

4.9.3 Creating LOP

4.9.3.1 Creating bearing LOP

- 1 After confirming that the [LOPs Fixing] tab is selected, select [Bearing].

The screenshot shows a 'Manual Position Fix' dialog box with two tabs: 'LOPs Fixing' (selected) and 'Position Offset'. The 'LOPs Fixing' tab contains the following fields and controls:

- LOP 1 (Total: 0,MAX:10)
- Observations Time
 - Date: ****_**_** (with a calendar icon showing 31)
 - Time: **:**:** (UTC)
- Position: **°**.**'***"
- (e.g. landmark) ****°**.'***"
- Bearing: ****.*°
- Distance: ****.* NM
- Transfer Position line
 - HDG/STW COG/SCG
 - HDG: 090.0° Set: 010.0°
 - STW: 10.0 kn DRIFT: 20.0 kn
- Buttons: Set, Delete
- Plot: Plot by Cursor
- Clear all lines

2 Place the cursor on the reference point.

The cursor (mark cursor) of the LOP reference point setting mode for the first LOP is displayed. In this case, the LOP starts from the edge of the screen and the LOP reference point is the cursor position.



3 Set the cursor to the target that was used for bearing measurement and click the mouse button. The cursor changes to the bearing setting cursor.

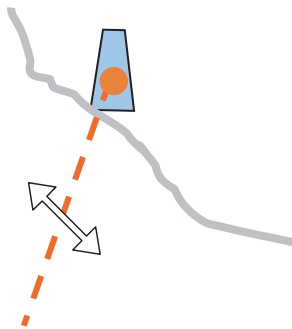

4 Move the cursor to set the bearing to the measured bearing and determine the bearing of the LOP by clicking the mouse button.

The measurement can also be determined by entering a numeric value in the Bearing text box.

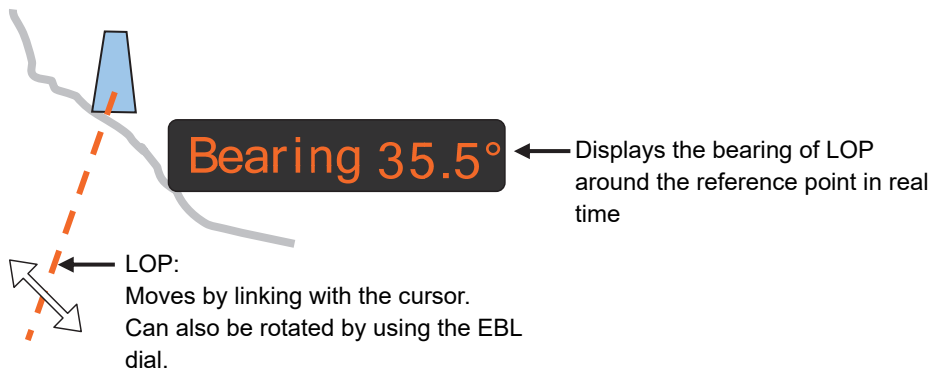

When the bearing of LOP is determined, the mark cursor is displayed and the cursor mode is changed to the reference point setting mode.



5 Determine the 1st LOP by clicking on the [Set] button.

The 2nd LOP is selected in the LOP selection combo box.

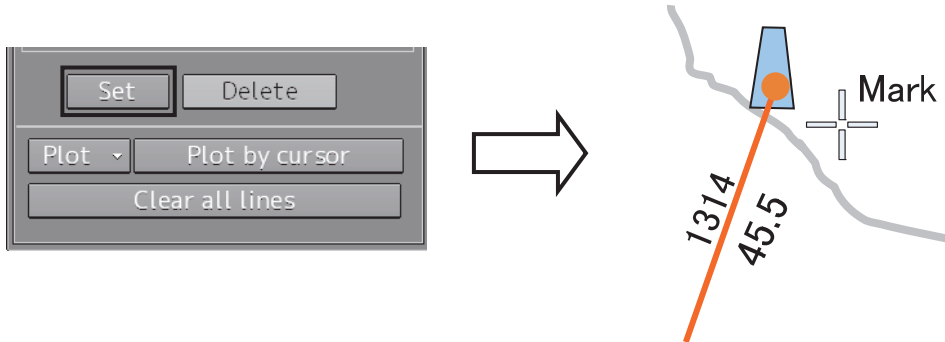

When LOP is determined, the broken line is changed to a solid line.

4.9.3.2 Creating distance LOP

1 Check that the [LOPs Fixing] tab is displayed and select [Distance].



2 Place the cursor on the reference point.

The cursor (mark cursor) is displayed.



- 3 When the cursor is moved to the target that is used for distance measurement and the mouse button is clicked on, the cursor changes to the arrow cursor.

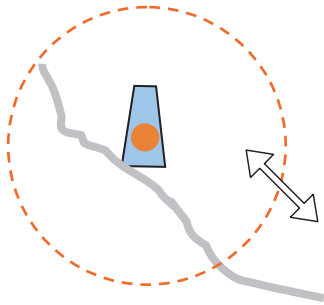

- 4 Move the cursor to the measured distance and determine the LOP distance by clicking the button.

A numeric value for the distance can also be input in the Distance text box.

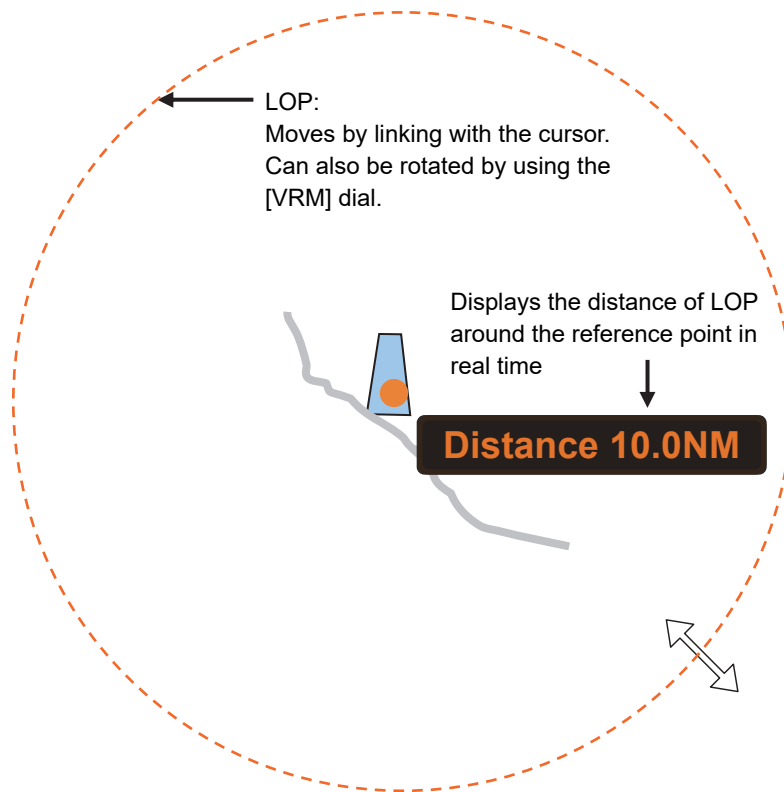

4.9.4 Measuring the own ship's position in cross bearing fix

This section describes the own ship position fixing and offset procedures by cross bearing (cross position fixing method).

In cross bearing, creation of a Plotted Position and offset operation can be performed concurrently.

When the own ship's position is unclear due to the occurrence of abnormality in the position sensor such as a navigation unit, the position of own ship can be determined by drawing a line of the bearing of the fixed target visually on the chart by using cross bearing.

4.9.4.1 Automatic position fixing

- 1 Create two or more LOPs to create intersecting points.

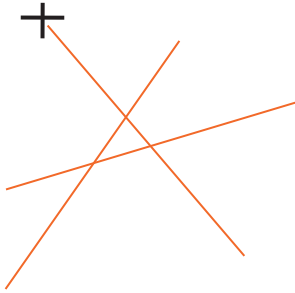

- 2 Click the [Plot] combo box.

Memo

The following menu is displayed only when two or more LOPs are determined.
When there are three or more LOPs or TPLs, refer to "4.9.4.4 When there are three or more LOPs or TPLs".

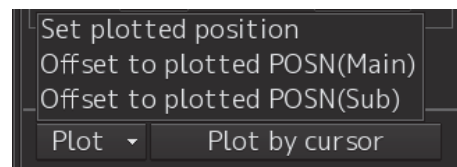

3 Select [Set plotted position].

A Plotted Position is displayed on the appropriate intersecting point.

When there are two LOPs, the intersecting point is used as the position fixing candidate and when there are three LOPs and a differential triangle is generated, the inner center is used as the position fixing candidate.

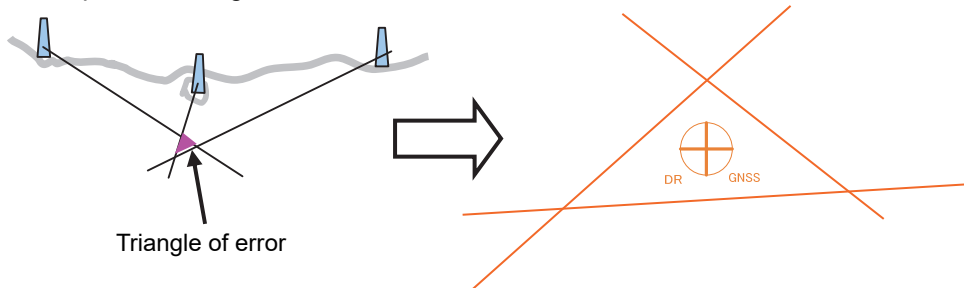

4 Set a Plotted Position in the [Plotted Position] dialog that is displayed at creation of a Plotted Position.

For the details of the [Plotted Position] dialog box, refer to "4.9.4.5 Setting a plotted position".

4.9.4.2 Automatic offset

1 Create two or more LOPs to create intersecting points.

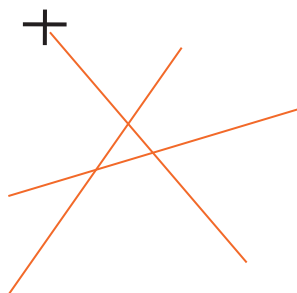

2 Click the [Plot] combo box.

Memo

The following menu is displayed only when two or more LOPs are determined.

When there are three or more LOPs or TPLs, refer to "4.9.4.4 When there are three or more LOPs or TPLs".

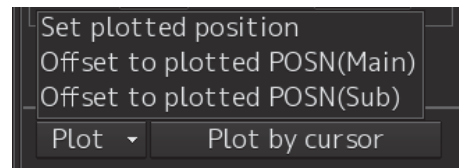

3 Select [Set plotted position].

A Plotted Position is displayed on the appropriate intersecting point.

When there are two LOPs, the intersecting point is used as the position fixing candidate and when there are three LOPs and a triangle of error is generated, the inner center is used as the position fixing candidate.

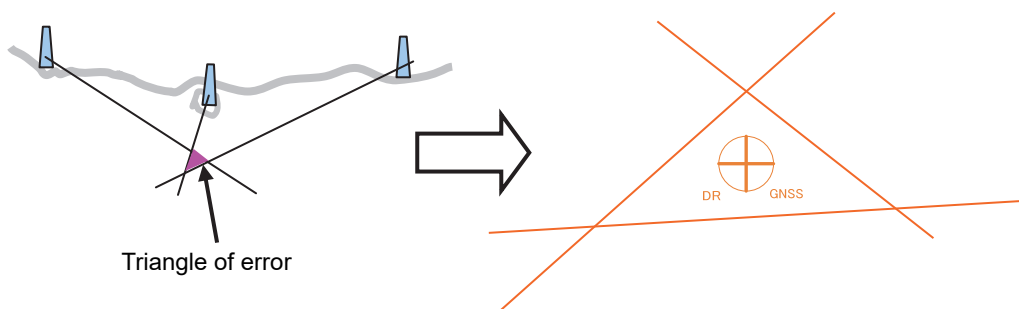

4 Select [Offset to plotted POSN(Main)] or [Offset to plotted POSN(SUB)] from the [Plot] combo box.

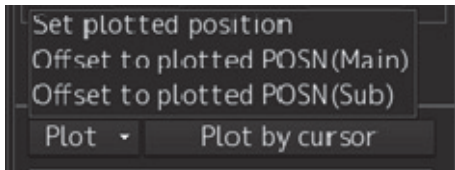

- When [Offset to plotted POSN(Main)] is selected, a reference point is created by offsetting by POSN1 from the plotted position.
- When [Offset to plotted POSN(Sub)] is selected, a reference point is created by offsetting by POSN2 from the plotted position.

4.9.4.3 Manual position fixing

1 Click on the [Plot by cursor].

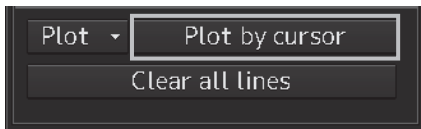

The mode is changed to the manual plot mode and the offset cursor is displayed.

2 Click inside of the triangle of error with the offset cursor.

A Plotted Position is displayed on the coordinate that was clicked on and the [Plotted Position] dialog box appears.

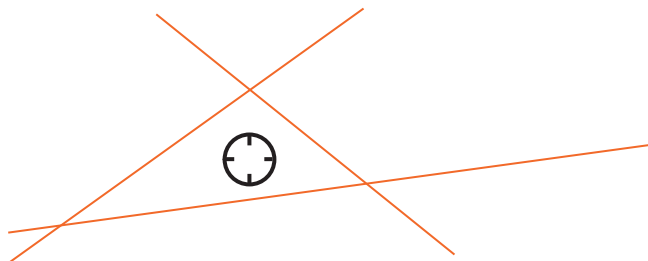

3 Set a Plotted Position in the [Plotted Position] dialog that is displayed at creation of a Plotted Position.

For the details of the [Plotted Position] dialog box, refer to the "4.9.4.5 Setting a plotted position".

4.9.4.4 When there are three or more LOPs or TPLs

When there are three or more LOPs or TPLs in total and the [Set plotted position] button is clicked on, the [Select LOP or TPL] dialog box appears.

Select LOP or TPL on the chart from this dialog box.

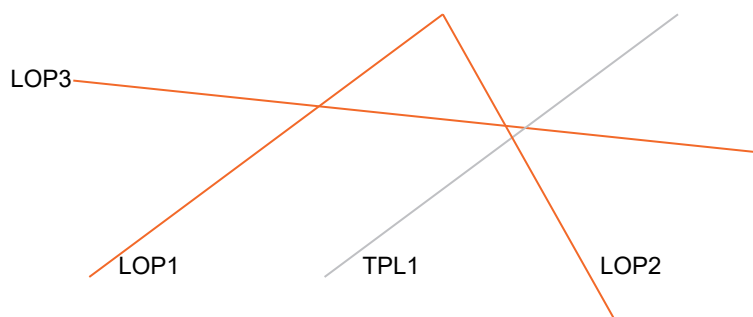
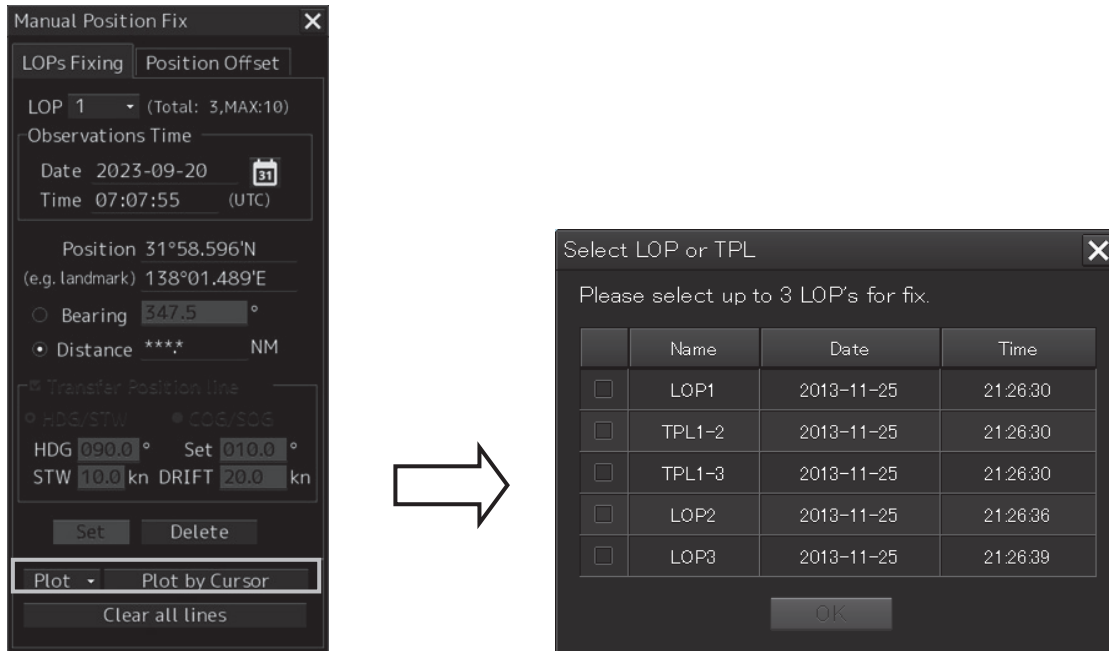

1 Select a LOP or TPL checkbox.

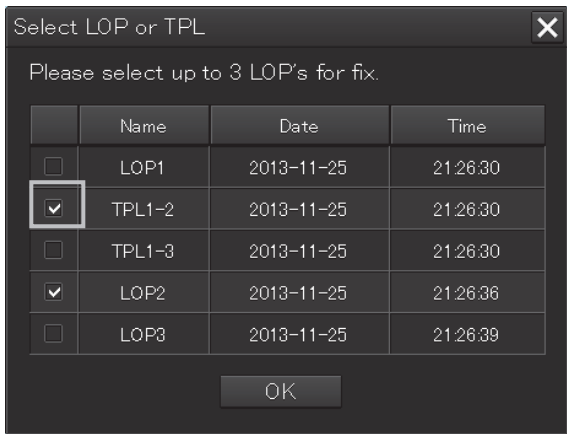

TPL display example

For instance, "TPL1-2" is expressed with the "LOP number" that is checked in [Transfer Position Line] and "LOP number of creation destination (transfer destination)".

The selected LOP or TPL is highlighted.

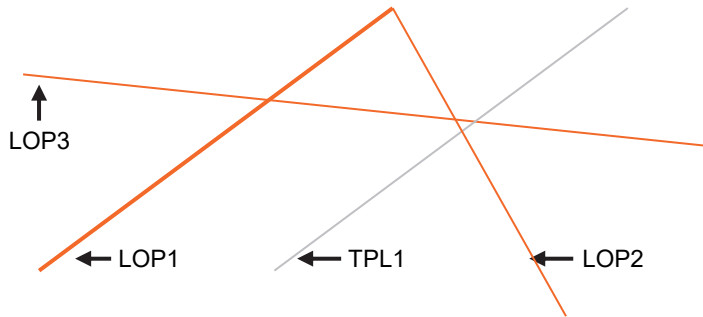

2 Close the dialog box by clicking on the [OK] button.

Important

The [OK] button on the dialog box is enabled under the following conditions only.

Position fixing method	Pattern where the [OK] button is enabled	Remarks
Cross Bearing	• BRG×2 • BRG×3	LOP bearing only is available for Cross Bearing.
Running fix	• BRG×1 TPL×1 • BRG×1 TPL×2	LOP and TPL bearing only are available for Running fix.
Bearing Distance	• BRG×1 DST×1	For Bearing Distance, the position is fixed by one LOP bearing and one LOP distance.
Radar fix	• DST×2 • DST×3	LOP distance only is available for Radar fix.

*BRG means "bearing LOP" and RNG means "distance LOP".

4.9.4.5 Setting a plotted position

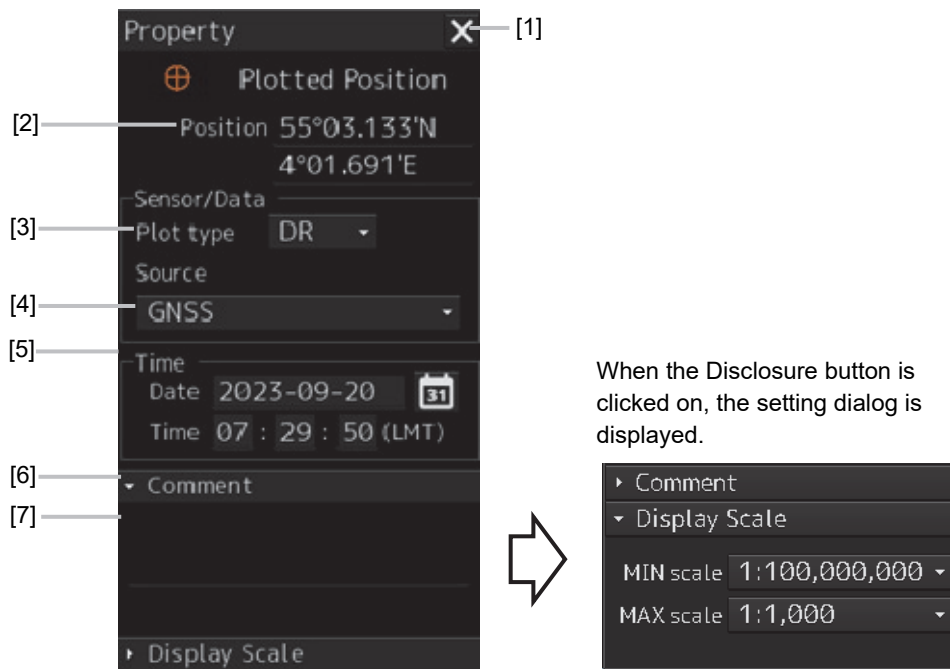

When the Disclosure button is clicked on, the setting dialog is displayed.

[1] [X] button

Close the [Property] dialog box.

[2] [Position]

Enter the coordinate of the Plotted Position.

Memo

The maximum latitude input range of Plotted Position is 85 ° 00.000 (polar range restriction)

[3] [Plot type] combo box

Switched between blank, DR(Dead Reckoning) and EP(Estimated Position).

Position by dead-reckoning (DR: Dead-Reckoning)

Position that is assumed based on the current course and speed

Estimated position (EP)

Position that is assumed by including the influence of wind and current in addition to the current course and speed

[4] [Source] (Data source) combo box

Select a data source from the list containing following 11 types.

Data source	
Blank	GPS
GNSS	DGPS
LORAN	DECCA
RADAR Range	Astronomical
Visual Bearing	MFDF
Visual BRG/RADAR RNG	TRANSIT

[5] [Time]

When the calendar icon  is clicked on, a calendar picker is displayed, enabling input of date and time.

[6] [Comment]

When the disclosure button of the Comment is clicked on, an input column is displayed. Enter a comment (up to 64 characters).

[7] Display Scale

When the disclosure button of Display Scale is clicked on, the scale range (minimum scale to maximum scale) for Plotted Position on the chart is displayed.

Select the minimum scale (MIN scale) and the maximum scale (MAX scale) as required.

4.9.5 Measuring the own ship's position with Running Fix

By using two LOPs and TPLs (Transfer Position Line) that were created at different times, an intersecting point or a triangle of error is created and the position is fixed.

The same procedure as for cross bearing is applied for automatic position fixing and manual position fixing.

1 Select the [Transfer Position Line] (ON/OFF of TPL) checkbox.

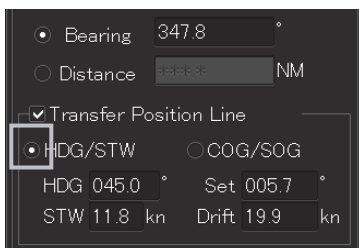

2 Select a TPL calculation method.

When determining TPL from the ship's heading through water, ship's speed, current direction, and current speed, select [HDG/STW].

To change the ship's heading, ship's speed through water, current direction, and current speed subsequently, change the value in each of the [HDG], [STW], [Set], and [Drift] boxes. To determine TPL from the ship's speed, select [COG/SOG].

3 Create the 1st LOP and click on the [Set] button.

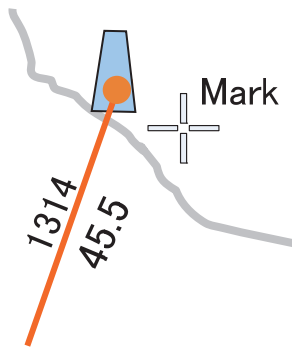

4 Wait until the ship moves for a while.

Note

While the ship is moving, do not change the bearing and speed of own ship.

Memo

When the traveling distance is available from the time difference from the 1st LOP to the observation time and the direction and speed of the ship, the 2nd LOP can also be created by entering the Observation Time of the LOP without waiting for the movement of the ship.

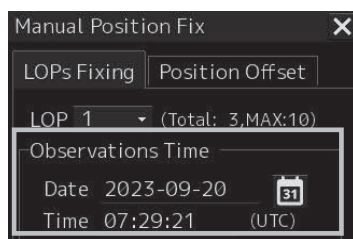

5 Select the [Transfer Position Line] check box.

6 Create the second LOP with the same procedure as for cross bearing.

TPL is automatically drawn by determining the traveling distance from the time difference from the 1st LOP to the observation time and the bearing and speed of the ship. The intersection between the 2nd LOP and TPL becomes the own ship's position based on the both-side positioning method.

- When [HDG/STW] is set to ON, TPL of the same angle as that of the 1st LOP and same time as that of 2nd LOP is created based on the position determined by adding the HDG/STW vector and the Set/Drift vector.
- When [COG/SOG] is ON, TPL is created by using COG/SOG.

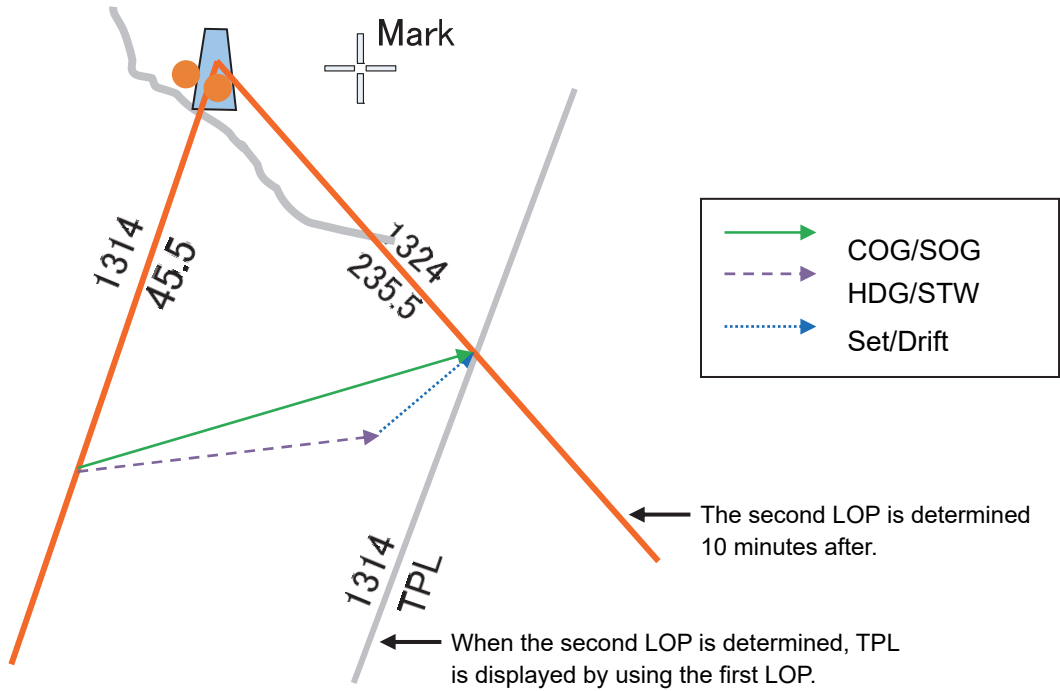

Note
 Since transfer to the past LOP is not possible, TPL cannot be created when the time of LOP is prior to the time of LOP1.

7 When using the intersection between LOP and TPL as the Plotted Position, perform the operation that is described in Memo.

When using a triangle of error as the Plotted Position, advance to Step 8.

Memo

The intersection between LOP and TPL can also be used as the Plotted Position.

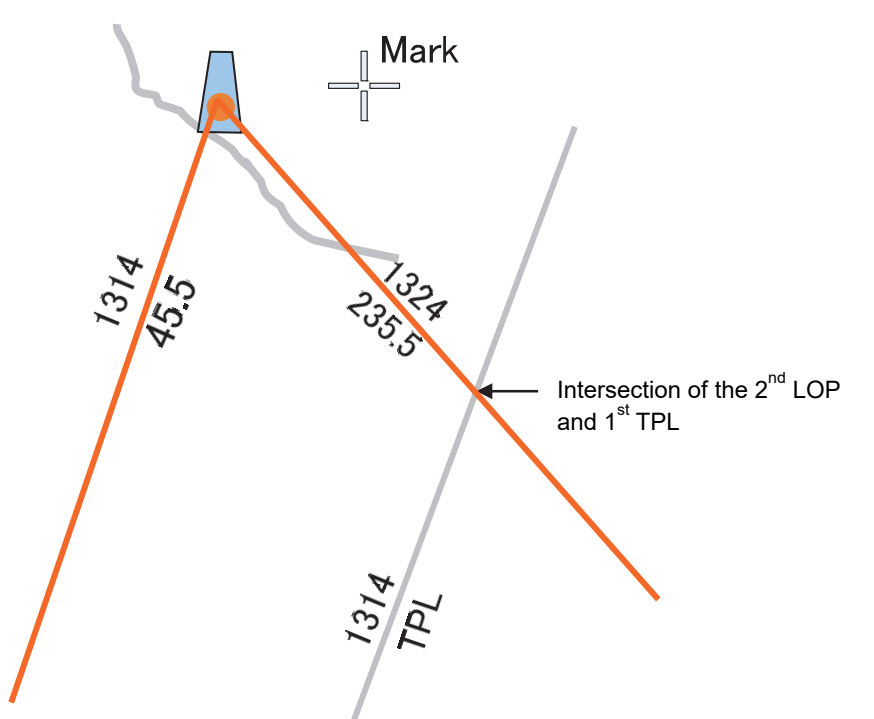

- 1 Select [Set plotted position] from the [Plot] button while an intersection is created from the 2nd LOP and 1st TPL.
The [Select LOP or TPL] dialog is displayed.
- 2 Select the 2nd LOP and 1st TPL and click on the [OK] button.
A Plotted Position is set at the intersection of the 2nd LOP and 1st TPL.

8 Check [Transfer Position Line].

9 Click on the [Set] button by creating the 2nd LOP.

TPL is automatically drawn by determining the traveling distance from the time difference from the 2nd LOP to the observation time and the bearing and speed of the ship.

Two TPLs are created, creating a triangle of error.

10 Select [Set plotted position] from the [Plot] button.

The [Select LOP or TPL] dialog is displayed.

11 Select LOP and TPL that form a triangle of error and click on the [OK] button.

A Plotted Position is set inside of the triangle of error.

4.9.6 Measuring the own ship's position with other methods

■ Bearing and Distance

Perform position fixing from one target with one Bearing and one Distance.

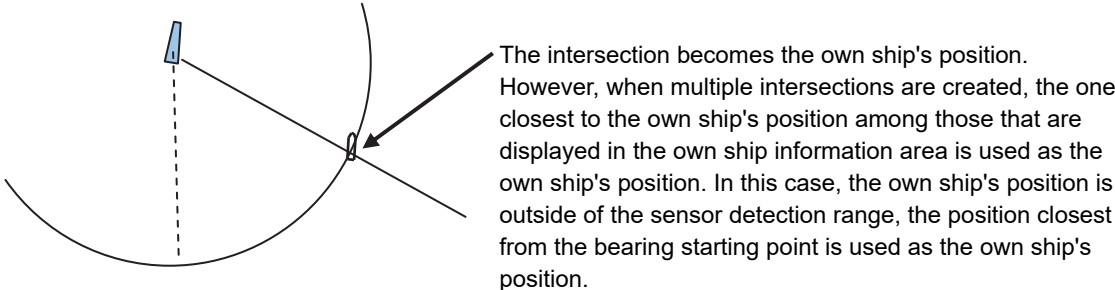

■ Distance

Perform position fixing from the distance intersecting point from 2 to 3 targets.

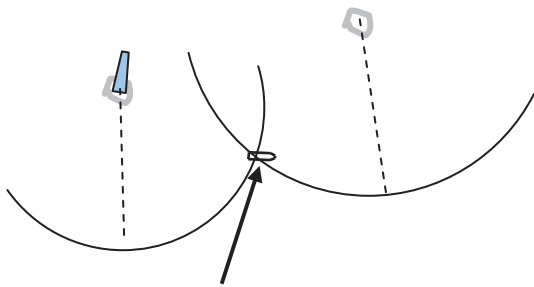

The intersection becomes the own ship's position. However, when multiple intersections are created, the one closest to the own ship's position among those that are displayed in the own ship information area is used as the own ship's position. In this case, the own ship's position is outside of the sensor detection range, the position closest from the bearing starting point is used as the own ship's position.

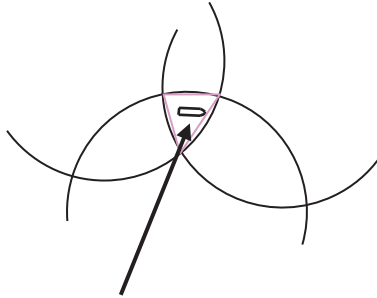

Inner center (position closer to the own ship's position) of the triangle of error created by 3 intersecting points when there are 3 distance LOPs.

4.10 Offsetting the Own Ship's Position Manually (Position Offset Function of Manual position fix)

WARNING

Do not use the offset function during the voyage.

If the function is used while an offset value is input in the own ship's position (different from the actual position), an accident may occur.

When an offset value is input, the [Offset] badge is displayed in the position display section of Own Ship Information. Check if the own ship is off course with this position display section. The "Position Shift" message is also displayed in the message area.



Position 1	
GPS 1 ▾	 12°32.324' N
	76°02.745' E

4.10.1 Displaying the [Manual Position Fix] dialog box

- 1 Click on the [Menu] button on the left toolbar.

The menu is displayed.

2 Click on the [Tools] - [Manual Position Fix] button on the menu.

The [Manual Position Fix] dialog box appears.

Manual position fix

LOPs Fixing Position Offset

LOP 2 (Total: 2,MAX:10)

Observations Time

Date 2014-05-19

Time 03:09:47 (UTC)

Position 38°50.380'S

(e.g. landmark) 145°59.790'E

Bearing 345.0 °

Distance 0.0 NM

Transfer Position Line

HDG/STW COG/SOG

HDG 000.0 ° Set 000.0 °

STW 10.0 kn Drift 10.0 kn

Set Delete

Plot Plot by cursor

Clear all lines

3 Click on the [Position Offset] tab.

The "Position Offset" dialog box appears.

4.10.2 Description of the [Position Offset] tab of the [Manual Position Fix] dialog box

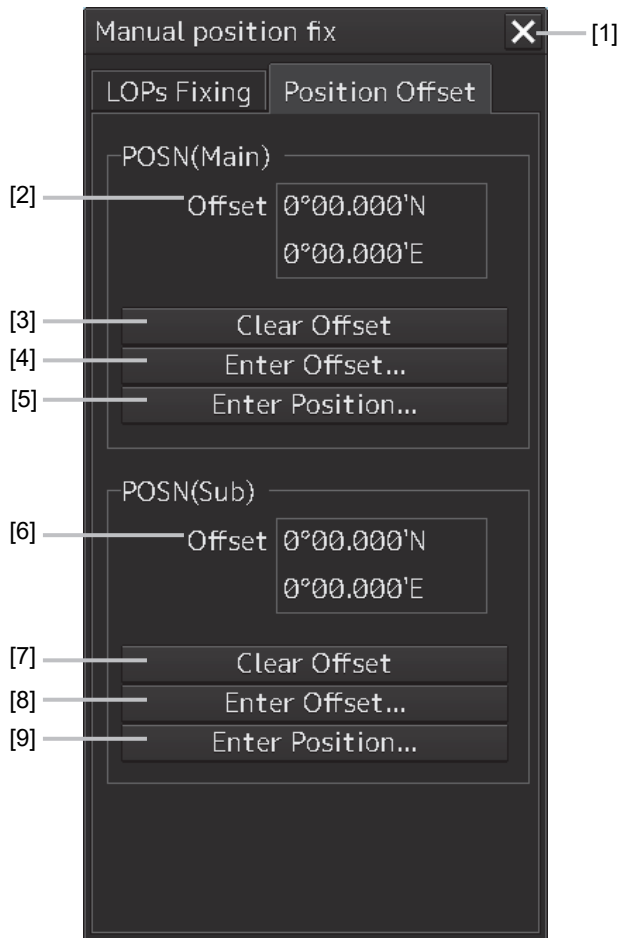

[1] [X] button

This button closes the [Manual Position Fix] dialog box.

[2] [Offset] ([POSN(Main)] coordinate after offset)

The offset amount that was offset by Enter Offset and Enter Position is displayed.

[3] [Clear Offset] (Clearing the offset value of [POSN(Main)]) button

The offset value of [POSN(Main)] is cleared.

[4] [Enter Offset] (Input of the offset value of [POSN(Main)]) button

This button displays the [Enter Offset] dialog box.

For the details, refer to "4.10.3 Setting the offset amount that is input in the [Enter Offset] dialog as the offset position".

[5] [Enter Position] (Coordinate input of [POSN(Main)]) button

This button displays the [Enter Position] dialog box.

For the details, refer to "4.10.4 Setting the position on the chart on which the mouse button was clicked as the offset position".

[6] Post-offset coordinate (Post-offset [POSN(Sub)]coordinate)

The offset amount is displayed.

[7] [Clear Offset] (Clearing the [POSN(Sub)] offset value) button

The offset value of [POSN(Sub)] is cleared.

[8] [Enter Offset] (Input of offset value of [POSN(Sub)]) button

This button displays the [Enter Offset] dialog box.

For the details, refer to "4.10.3 Setting the offset amount that is input in the [Enter Offset] dialog as the offset position".

[9] [Enter Position] (Coordinate input of [POSN(Sub)]) button

This button displays the [Enter Position] dialog box.

For the details, refer to "4.10.4 Setting the position on the chart on which the mouse button was clicked as the offset position".

4.10.3 Setting the offset amount that is input in the [Enter Offset] dialog as the offset position

- 1** Click on the [Enter Offset] (Setting the offset amount) button of [POSN(Main)] or [POSN(Sub)].
The [Enter Offset] dialog is displayed.
- 2** Enter an offset value through the software keyboard.

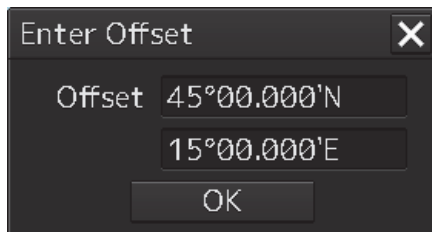
**Memo**

The maximum latitude input range of Enter Offset is 85 ° 00.000 (polar range restriction).

- 3** Click on the [OK] button.
The offset amount that was input is set as the offset position.

4.10.4 Setting the position on the chart on which the mouse button was clicked as the offset position

- 1 Click on the [Enter Position] (input of coordinates) button of [POSN(Main)] or [POSN(Sub)].

The [Enter Position] dialog is displayed.

While the dialog is displayed, the cursor changes to the offset cursor and the mode changes to the position selection mode.

- 2 The position is displayed in [Position] in the dialog as the coordinate of the position on the chart on which the mouse button was clicked.

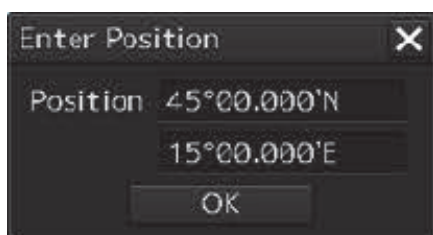

Memo

Post-offset coordinates can also be input from the software keyboard.

- 3 Click on the [OK] button.

The coordinate is set in the offset position.

Notation of Plotted Position on the chart

When offset is applied to automatic plot, manual plot, or own ship's position, the time and source are displayed near the symbol.

The source is displayed with the following label.

	Label	Details
Estimated position	EP	
Dead reckoned position	DR	
Plotted Position	GNSS	GNSS
	L	Loran
	R	Radar range
	V	Visual bearing
	VR	Visual BRG/Radar RNG
	G	GPS
	dG	DGPS
	D	Decca
	A	Astronomical
	M	MFDF
T	TRANSIT	

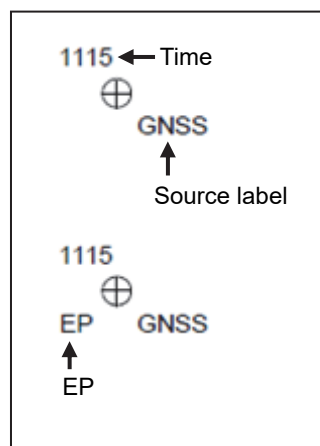

4.10.5 Recording LOPs Fixing operation in the logbook

A comment can be registered in the log book by using the following procedure.

Display example when a Plotted Position is created by using Set plotted position or Plot by cursor.

<p>Fixed position was plotted at Jan 01,2012 12:00:48 by "Set plotted position".</p> <p>Offset: 0.8 NM, 014.6°</p> <p>Plotted position: 60°12.493' N, 027°48.254' E</p> <p>The following lines of position were used.</p> <p>LOP1: Jan 01,2012 11:57:22, BRG = 044.6°</p> <p>LOP2: Jan 01,2012 11:58:27, BRG = 322.0°</p> <p>LOP3: Jan 01,2012 11:58:52, BRG = 266.1°</p> <p>Intersection of LOP1 and LOP2: 60°20.623' N, 028°06.209' E</p> <p>Intersection of LOP1 and LOP3: 60°16.684' N, 027°40.879' E</p> <p>Intersection of LOP2 and LOP3: 60°12.249' N, 027°38.318' E</p>	<p>← Plotted Position creation date and time and Plot type</p> <p>← Offset value</p> <p>← Coordinates at creation of the Plotted Position</p> <p>← Fixed character string *Not displayed under Plot by cursor</p> <p>← LOP type (ascending order), creation date and time, and bearing or distance *2 to 3 LOPs are used for position fixing. *For bearing, BRG is displayed and for distance, DST is displayed. *Not displayed under Plot by cursor</p> <p>← Intersection coordinate of LOP *Not displayed under Plot by cursor</p>
---	--

Display example when the own ship position is offset by [Offset to plotted POSN(Main/Sub)].

<p>Main position was offset at Jan 01,2012,12:00:48 by "Offset to plotted POSN(Main)".</p> <p>Offset: 0.8 NM, 014.6°</p> <p>Plotted position: 60°12.493' N, 027°48.254'E</p> <p>The following lines of position were used.</p> <p>LOP1: Jan 01,2012 11:57:22, BRG = 044.6°</p> <p>LOP2: Jan 01,2012 11:58:27, BRG = 322.0°</p> <p>LOP3: Jan 01,2012 11:58:52, BRG = 266.1°</p> <p>Intersection of LOP1 and LOP2: 60°20.623' N, 028°06.209' E</p> <p>Intersection of LOP1 and LOP3: 60°16.684' N, 027°40.879' E</p> <p>Intersection of LOP2 and LOP3: 60°12.249' N, 027°38.318' E</p>	<p>← Offset date and time and offset type *When the position is offset by Offset to plotted POSN(Main), "Main position" is displayed and when the position is offset by Offset to plotted POSN(Sub), "Sub position" is displayed.</p> <p>← Offset value</p> <p>← Offset coordinate</p> <p>← Fixed character string</p> <p>← LOP type (ascending order), creation date and time, and bearing or distance *2 to 3 LOPs are used for position fixing. *For bearing, BRG is displayed and for distance, DST is displayed.</p> <p>← Intersection coordinate of LOP</p>
--	---

Display example when the own ship position is offset by Enter Offset of the [Position Offset] tab

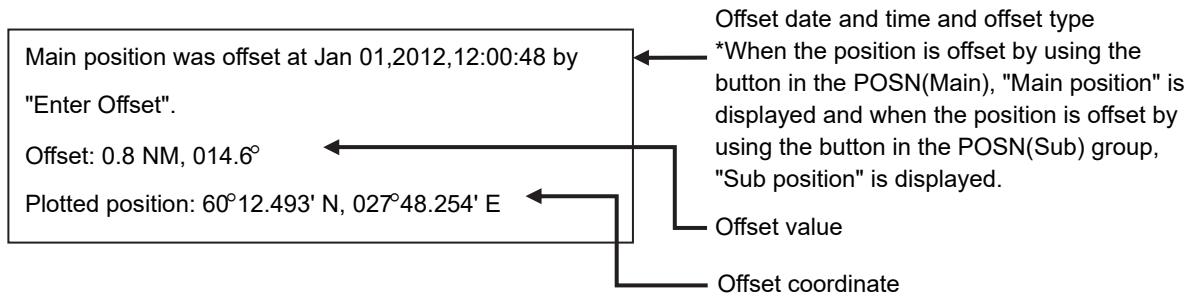

Display example when the own ship position is offset by Enter Position of the [Position Offset] tab

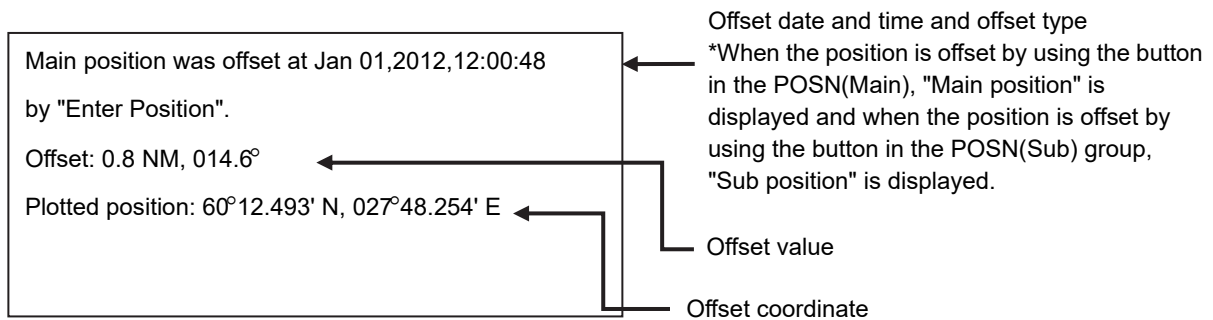

Display example when the own ship position is offset by Clear Offset of the [Position Offset] tab

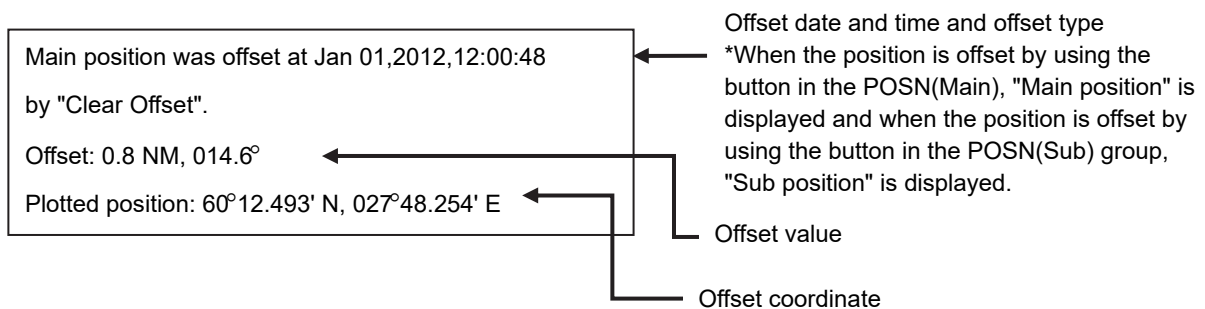

4.10.6 Offsetting the own ship position

When the own ship position is offset by Offset to plotted POSN(Main/Sub) and Enter Offset, Enter Position, and Clear Offset in Position Offset, the following character strings are registered in the Logbook.

Item	Statement	Display contents
Offset to plotted POSN(Main/Sub) *For the "Offset to plotted POSN(Main)" section, "Offset to plotted POSN(Main)" or "Offset to plotted POSN(Sub)" is displayed.	Main position was offset at Jan 01,2012,12:00:48 by "Offset to plotted POSN(Main)". Offset: 0.8 NM, 014.6° Plotted position: 60°12.493' N, 027°48.254' E The following lines of position were used. LOP1: Jan 01,2012 11:57:22, BRG = 044.6° LOP2: Jan 01,2012 11:58:27, BRG = 322.0° LOP3: Jan 01,2012 11:58:52, BRG = 266.1° Intersection of LOP1 and LOP2: 60°20.623' N, 028°06.209' E Intersection of LOP1 and LOP3: 60°16.684' N, 027°40.879' E Intersection of LOP2 and LOP3: 60°12.249' N, 027°38.318' E	<ul style="list-style-type: none"> • First line: Offset date and time, offset type <p>*When the position is offset by Offset to plotted POSN(Main), "Main position" is displayed and when the position is offset by Offset to plotted POSN(Sub), "Sub position" is displayed.</p> <ul style="list-style-type: none"> • Second line: Offset value • Third line: Offset coordinate • Fourth line: Fixed character string • Fifth to seventh lines: LOP type (ascending order), creation date and time, bearing or distance <p>*2 to 3 LOPs are used for position fixing</p> <p>*For bearing BRG is displayed and for distance, DST is displayed.</p> <ul style="list-style-type: none"> • Eighth to tenth lines: Intersection coordinates of LOP
Enter Offset	Main position was offset at Jan 01,2012,12:00:48 by "Enter Offset". Offset: 0.8 NM, 014.6° Plotted position: 60°12.493' N, 027°48.254' E	<ul style="list-style-type: none"> • First line: Offset date and time <p>*When the position is offset by using the button in the POSN(Main), "Main position" is displayed and when the position is offset by using the button in the POSN(Sub) group, "Sub position" is displayed.</p> <ul style="list-style-type: none"> • Second line: Offset value • Third line: Offset coordinate
Enter Position	Main position was offset at Jan 01,2012,12:00:48 by "Enter Position". Offset: 0.8 NM, 014.6° Plotted position: 60°12.493' N, 027°48.254' E	<ul style="list-style-type: none"> • First line: Offset date and time <p>* If offset with a button in the POSN(Main) group, "Main position" is displayed; if offset with a button in the POSN(Sub) group, "Sub position" is displayed.</p> <ul style="list-style-type: none"> • Second line: Offset value • Third line: Offset coordinates
Clear Offset	Main position was offset at Jan 01,2012,12:00:48 by "Clear Offset". Offset: 0.8 NM, 014.6° Plotted position: 60°12.493' N, 027°48.254' E	<ul style="list-style-type: none"> • First line: Offset date and time <p>* If offset with a button in the POSN(Main) group, "Main position" is displayed; if offset with a button in the POSN(Sub) group, "Sub position" is displayed.</p> <ul style="list-style-type: none"> • Second line: Offset value • Third line: Offset coordinates

アスベストは使用していません
Not use the asbestos

For further information, contact:

JRC *Japan Radio Co., Ltd.*

Since 1915

URL Head office : <http://www.jrc.co.jp/eng/>

Marine Service Department

1-7-32 Tatsumi, Koto-ku, Tokyo 135-0053, Japan

e-mail : tmsc@jrc.co.jp

One-call : +81-50-3786-9201

ISO 9001, ISO 14001 Certified

CODE No.7ZPNA4449N

DEC. 2023 Edition 15