

JLZ-1000

Color Plotter

Instruction Manual

Overview	1
Name and Function of Each Unit	2
Installation	3
Common Basic Operations	4
Map Screen Operation Procedure	5
How to Use Various Screens	6
Function Menus	7
System Configuration Menus	8
Setting and Executing Shortcuts	9
Maintenance & Inspection	10
After-Sale Services	11
About Disposal	12
Specifications	13
Appendix/Reference Materials	14

● Safety Cautions ●

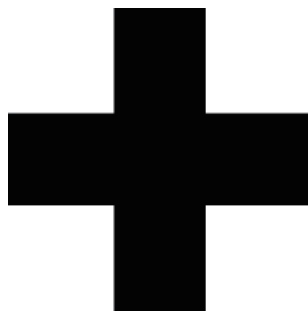

Cautions for High Voltage

High voltages, ranging from several hundreds to tens of thousands of volts, are used in electronic apparatus, such as radio and radar instruments. These voltages are totally harmless in most operations. However, touching a component inside the unit is very dangerous. (Any person other than authorized service engineers should not maintain, inspect, or adjust the unit.) High voltages on the order of tens of thousand volts are most likely to cause instant deaths from electrical shocks. At times, even voltages on the order of several hundred volts could lead to electrocution. To defend against electrical shock hazards, don't put your hand into the inside of apparatus.

When you put in a hand unavoidably in case of urgent, it is strongly suggested to turn off the power switch and allow the capacitors, etc. to discharge with a wire having its one end positively grounded to remove residual charges. Before you put your hand into the inside of apparatus, make sure that internal parts are no longer charged. Extra protection is ensured by wearing dry cotton gloves at this time. Another important precaution to observe is to keep one hand in your pocket at a time, instead of using both hands at the same time. It is also important to select a secure footing to work on, as the secondary effects of electrical shock hazards can be more serious. In the event of electrical shocks, disinfect the burnt site completely and obtain medical care immediately.

Precautions for Rescue of Victim of Electric Shock

When a victim of electric shock is found, turn off the power source and ground the circuit immediately. If this is impossible, move the victim away from the unit as quick as possible without touching him or her with bare hands. He or she can safely be moved if an insulating material such as dry wood plate or cloth is used.

It is necessary to perform first aid immediately.

Breathing may stop if current flows through the respiration center of brain due to electric shock. If the electric shock is not large, breathing can be restored by artificial respiration. A victim of electric shock looks pale and his or her pulse may become very weak or stop, resulting in unconsciousness and rigidity at worst.

● Emergency Measures ●

Method of First-Aid Treatment

☆ Precautions for First-Aid Treatments

Apply artificial respiration to the person who collapsed, minimizing moving as much as possible avoiding risks. Once started, artificial respiration should be continued rhythmically.

- (1) Refrain from touching the patient carelessly as a result of the accident; the first-aiders could suffer from electrical shocks by himself or herself.
- (2) Turn off the power calmly and certainly, and move the patient apart from the cable gently.
- (3) Call or send for a physician or ambulance immediately, or ask someone to call doctor.
- (4) Lay the patient on the back, loosening the necktie, clothes, belts and so on.
- (5)
 - (a) Feel the patient's pulse.
 - (b) Check the heartbeat by bringing your ear close to the patient's heart.
 - (c) Check for respiration by bringing your face or the back of your hand to the patient's face.
 - (d) Check the size of patient's pupils.
- (6) Opening the patient's mouth, remove artificial teeth, cigarettes, chewing gum, etc. if any. With the patient's mouth open, stretch the tongue and insert a towel or the like into the mouth to prevent the tongue from being withdrawn into the throat. (If the patient clenches the teeth so tight that the mouth won't open, use a screwdriver or the like to force the mouth open and then insert a towel or the like into the mouth.)
- (7) Wipe off the mouth to prevent foaming mucus and saliva from accumulating.

Flow of Cardiopulmonary Resuscitation (CPR)

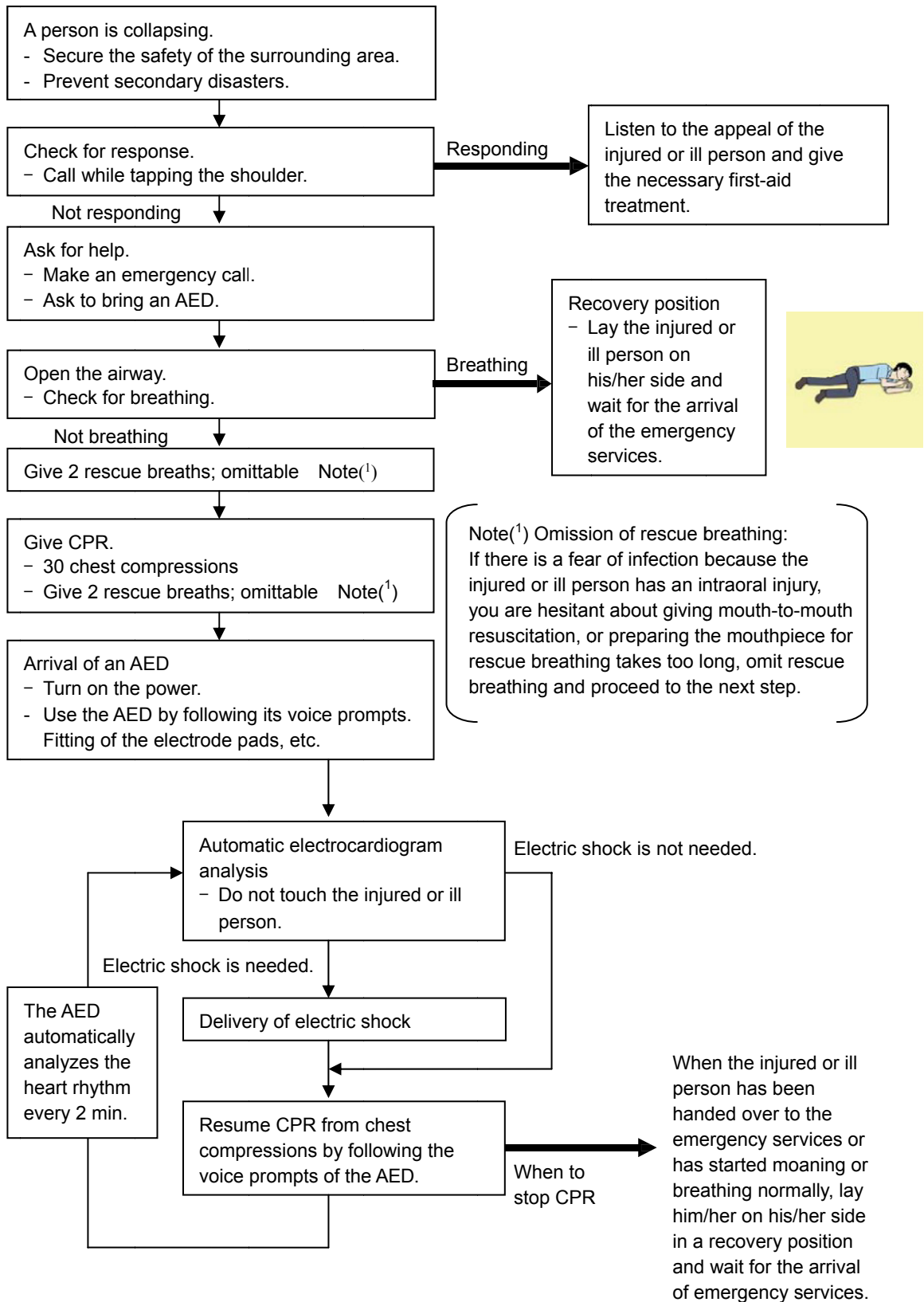

Specific Procedures for Cardiopulmonary Resuscitation (CPR)

1. Check the scene for safety to prevent secondary disasters

- a) Do not touch the injured or ill person in panic when an accident has occurred. (Doing so may cause electric shock to the first-aiders.)
- b) Do not panic and be sure to turn off the power. Then, gently move the injured or ill person to a safe place away from the electrical circuit.



2. Check for responsiveness

- a) Tap the shoulder of the injured or ill and shout in the ear saying, "Are you OK?"
- b) If the person opens his/her eyes or there is some response or gesture, determine it as "responding." But, if there is no response or gesture, determine it as "not responding."

3. If responding

- a) Give first-aid treatment.

4. If not responding

- a) Ask for help loudly. Ask somebody to make an emergency call and bring an AED.
 - Somebody has collapsed. Please help.
 - Please call an ambulance.
 - Please bring an **AED**.
 - If there is nobody to help, call an ambulance yourself.

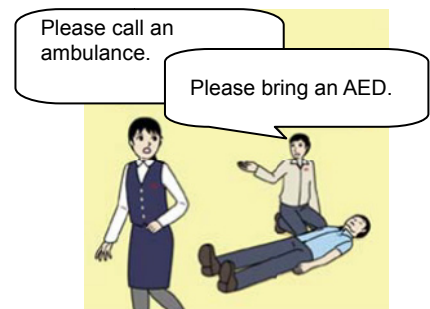

5. Open the airway

- a) Touch the forehead with one hand. Lift the chin with the two fingers of the middle finger and forefinger of the other hand and push down on the forehead as you lift the jaw to bring the chin forward to open the airway. If neck injury is suspected, open the airway by lifting the lower jaw.

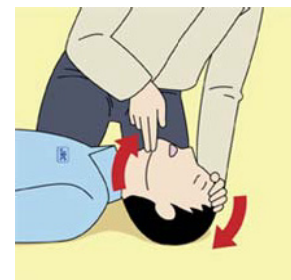

6. Check for breathing

- a) After opening the airway, check quickly for breathing for no more than 10 seconds. Put your cheek down by the mouth and nose area of the injured or ill person, look at his/her chest and abdomen, and check the following three points.
 - Look to see if the chest and abdomen are rising and falling.
 - Listen for breathing.
 - Feel for breath against your cheek.

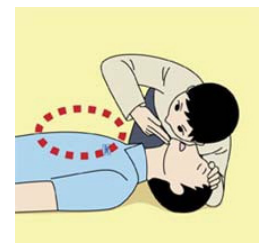

- b) If the injured or ill person is breathing, place him/her in the recovery position and wait for the arrival of the emergency services.
- Position the injured or ill person on his/her side, maintain a clear and open airway by pushing the head backward while positioning their mouth downward. To maintain proper blood circulation, roll him/her gently to position them in the recovery position in the opposite direction every 30 minutes.

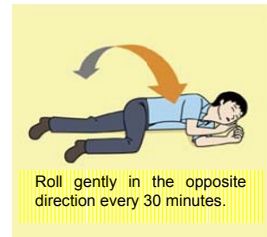

7. Give 2 rescue breaths (omittable)

- a) If opening the airway does not cause the injured or ill person to begin to breathe normally, give rescue breaths.
- b) If there is a fear of infection because the injured or ill person has an intraoral injury, you are hesitant about giving mouth-to-mouth resuscitation, or getting and preparing the mouthpiece for rescue breathing takes too long, omit rescue breathing and perform chest compressions.
- c) When performing rescue breathing, it is recommended to use a mouthpiece for rescue breathing and other protective devices to prevent infections.
- d) While maintaining an open airway, pinch the person's nose shut with your thumb and forefinger of the hand used to push down the forehead.
- e) Open your mouth widely to completely cover the mouth of the injured or ill person so that no air will escape. Give rescue breathing twice in about 1 second and check if the chest rises.

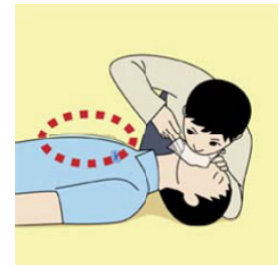

8. Cardiopulmonary resuscitation (CPR) (combination of chest compressions and rescue breaths)

- a) Chest compressions
- 1) Position of chest compressions
- Position the heel of one hand in the center of the chest, approximately between the nipples, and place your other hand on top of the one that is in position.

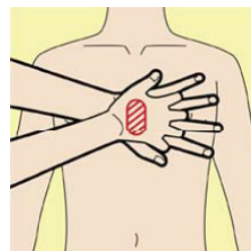
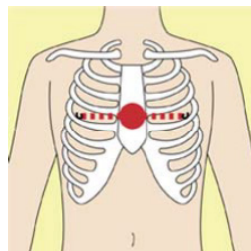

2) Perform chest compressions

- Perform uninterrupted chest compressions of 30 at the rate of about 100 times per minute. While locking your elbows positioning yourself vertically above your hands.

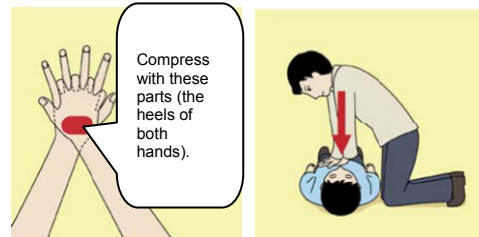

- With each compression, depress the chest wall to a depth of approximately 4 to 5 cm.

b) Combination of 30 chest compressions and 2 rescue breaths

- 1) After performing 30 chest compressions, give 2 rescue breaths. If rescue breathing is omitted, perform only chest compressions.
- 2) Continuously perform the combination of 30 chest compressions and 2 rescue breaths without interruption.
- 3) If there are two or more first-aiders, alternate with each other approximately every two minutes (five cycles of compressions and ventilations at a ratio of 30:2) without interruption.

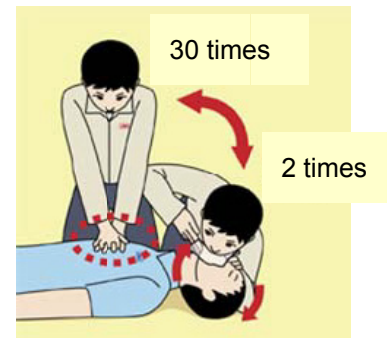

9. When to stop cardiopulmonary resuscitation (CPR)

- a) When the injured or ill person has been handed over to the emergency services
- b) When the injured or ill person has started moaning or breathing normally, lay him/her on his/her side in a recovery position and wait for the arrival of emergency services.

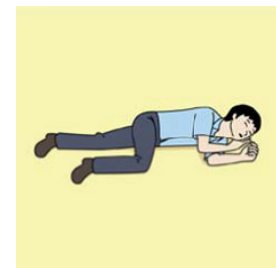

10. Arrival and preparation of an AED

- a) Place the AED at an easy-to-use position. If there are multiple first-aiders, continue CPR until the AED becomes ready.
- b) Turn on the power to the AED unit. Depending on the model of the AED, you may have to push the power on button, or the AED automatically turns on when you open the cover.
- c) Follow the voice prompts of the AED.

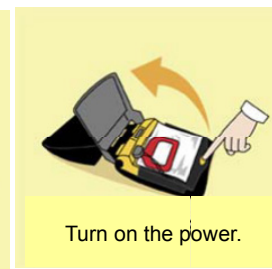
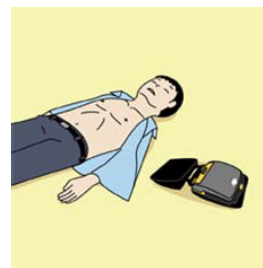

11. Attach the electrode pads to the injured or ill person's bare chest

- a) Remove all clothing from the chest, abdomen, and arms.
- b) Open the package of electrode pads, peel the pads off and securely place them on the chest of the injured or ill person, with the adhesive side facing the chest. If the pads are not securely attached to the chest,

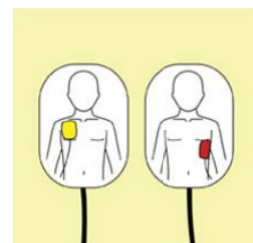

the AED may not function. Paste the pads exactly at the positions indicated on the pads. If the chest is wet with water, wipe dry with a dry towel and the like, and then paste the pads. If there is a pacemaker or implantable cardioverter defibrillator (ICD), paste the pads at least 3cm away from them. If a medical patch or plaster is present, peel it off and then paste the pads. If the injured or ill person's chest hair is thick, paste the pads on the chest hair once, peel them off to remove the chest hair, and then paste new pads.

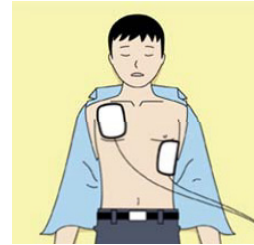

- c) Some AED models require to connect a connector by following voice prompts.
- d) The electrode pads for small children should not be used for children over the age of 8 and for adults.

12. Electrocardiogram analysis

- a) The AED automatically analyzes electrocardiograms. Follow the voice prompts of the AED and ensure that nobody is touching the injured or ill person while you are operating the AED.
- b) On some AED models, you may need to push a button to analyze the heart rhythm.



13. Electric shock (defibrillation)

- a) If the AED determines that electric shock is needed, the voice prompt saying, "Shock is needed" is issued and charging starts automatically.
- b) When charging is completed, the voice prompt saying, "Press the shock button" is issued and the shock button flashes.
- c) The first-aider must get away from the injured or ill person, make sure that no one is touching him/her, and then press the shock button.
- d) When electric shock is delivered, the body of the injured or ill person may jerk.

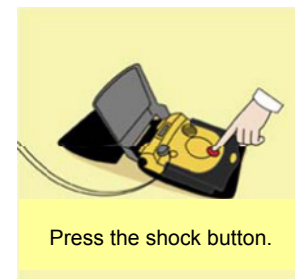

14. Resume cardiopulmonary resuscitation (CPR).

Resume CPR consisting of 30 chest compressions and 2 rescue breaths by following the voice prompts of the AED.



15. Automatic electrocardiogram analysis

- a) When 2 minutes have elapsed since you resumed cardiopulmonary resuscitation (CPR), the AED automatically analyzes the electrocardiogram.
- b) If you suspended CPR by following voice prompts and AED voice prompt informs you that shock is needed, give electric shock again by following the voice prompts. If AED voice prompt informs you that no shock is needed, immediately resume CPR.

16. When to stop CPR (Keep the electrode pads on.)

- a) When the injured or ill person has been handed over to the emergency services
- b) When the injured or ill person has started moaning or breathing normally, lay him/her on his/her side in a recovery position and wait for the arrival of emergency services.

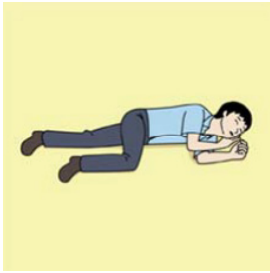

Contents

Safety Cautions	i
Emergency Measures	ii
Contents.....	ix
PREFACE	xvii
Pictorial Marks Used in This Manual	xviii
Precautions upon Equipment Operation	xix
EQUIPMENT APPEARANCE	xxv
List of abbreviations.....	xxvi
Terminology	xxvii
How to Use This Manual.....	xxviii
Section 1 Overview of the Equipment.....	1-1
1.1 Functions.....	1-1
1.2 Features	1-1
1.3 Configuration.....	1-2
1.4 Structure.....	1-3
1.4.1 NCH-748 operation unit.....	1-3
1.4.2 NDC-1752 processing unit.....	1-4
1.5 Comprehensive system diagram	1-5
Section 2 Name and Function of Each Unit.....	2-1
2.1 NCH-748 operation unit	2-1
2.2 NDC-1752 processing unit.....	2-3
Section 3 Installation	3-1
3.1 Installing the equipment.....	3-2
3.1.1 Installing the processing unit	3-2
3.1.1.1 Selecting an installation location	3-2
3.1.1.2 Floor-mounting installation	3-3
3.1.1.3 Wall-mounting installation.....	3-4
3.1.2 Installing an operation unit.....	3-5
3.2 Connecting cables.....	3-7
3.3 Connecting a card	3-21
Section 4 Basic Operation.....	4-1
4.1 Turning on/off the power supply.....	4-1
4.1.1 Turning on the power supply.....	4-1
4.1.2 Turning off the power supply.....	4-2
4.2 How to interpret the screen	4-3

4.2.1	Switching the main screen.....	4-4
4.2.1.1	Switching the main screen.....	4-4
4.2.2	Switching an active screen	4-5
4.2.2.1	Switching an active screen	4-5
4.2.3	Switching the Data bar pattern	4-5
4.2.3.1	Switching a Data bar pattern	4-5
4.2.4	Details of a status bar	4-6
4.3	Switching a screen brightness	4-8
4.4	Changing the setting on the menu	4-8
4.4.1	Displaying a menu	4-8
4.4.2	Operating the System Configuration menu/function menu.....	4-9
4.4.2.1	Menu levels	4-9
4.4.2.2	Keys that are used for menu operations	4-9
4.4.2.3	Example of menu operations.....	4-10
Section 5	Map Screen Operation Procedure	5-1
5.1	Map card and screen display	5-1
5.2	Basic map operation procedure	5-1
5.2.1	Zooming in/zooming out a map	5-1
5.2.2	Presetting scale values	5-1
5.2.2.1	Presetting scale values.....	5-1
5.2.2.2	Switching a scale to a preset scale	5-2
5.2.3	Moving a map	5-2
5.2.3.1	Moving a map by using the  (Up/Down/Left/Right) keys.....	5-2
5.2.3.2	Moving a map by using the trackball	5-2
5.2.4	Changing the contents that are displayed on a map	5-2
5.2.4.1	Setting a chart level	5-3
5.2.4.2	Switching a chart level.....	5-4
5.2.5	Switching a bearing mode	5-5
5.2.5.1	Motion mode and bearing mode.....	5-5
5.2.5.2	Switching a bearing mode	5-5
5.2.6	Displaying a map by placing own ship at the center.....	5-5
5.2.7	Displaying a map by placing the cursor position at the center	5-5
5.3	Using parallel index cursor / circular cursor	5-6
5.3.1	Displaying a variable cursor.....	5-6
5.3.1.1	Operating a variable cursor	5-6
5.3.1.2	Ending a measuring mode.....	5-6
5.3.1.3	Clearing a variable cursor.....	5-6
5.4	Selecting a color of a mark/track.....	5-7
5.4.1	Selecting a color of a mark	5-7
5.4.2	Selecting a track color	5-7
5.5	Setting the details of Track & Log display	5-8
5.5.1	Displaying the [Tracks] menu.....	5-8

5.5.2	Displaying track details	5-9
5.6	Drawing lines.....	5-14
5.6.1	Setting a plotting mode	5-14
5.6.1.1	Displaying a plotting menu	5-14
5.6.2	Drawing a line	5-14
5.6.3	Drawing a polygon	5-15
5.6.4	Writing characters	5-16
5.6.5	Deleting graphics and characters.....	5-16
5.6.5.1	Undisplaying graphics and characters	5-16
5.6.5.2	Deleting a specified line and a polygon	5-17
5.6.5.3	Deleting a specified character string	5-17
5.6.5.4	Deleting all the lines	5-17
5.6.5.5	Deleting all the character strings	5-17
5.6.6	Drawing lines while entering latitude and longitude.....	5-18
5.7	Registering a mark (destination).....	5-19
5.7.1	Registering a mark at the cursor position	5-19
5.7.1.1	Checking registered marks.....	5-19
5.7.2	Registering a mark at the own ship's position	5-20
5.7.2.1	Registering a mark while the map is displayed	5-20
5.7.2.2	Registering a mark in the [Waypoints] list	5-20
5.7.3	Editing a mark.....	5-20
5.7.3.1	Changing names, positions, and shapes collectively.....	5-20
5.7.3.2	Moving a mark.....	5-21
5.7.4	Deleting a mark.....	5-21
5.7.4.1	Deleting a mark by specifying it on the map.....	5-21
5.7.4.2	Deleting a mark from the [Waypoints] list.....	5-21
5.7.4.3	Deleting all the marks	5-22
5.7.5	Other operation procedures relating to marks	5-22
5.7.5.1	Displaying any mark at the center of the map.....	5-22
5.7.5.2	Searching a mark with the name.....	5-22
5.7.5.3	Sorting marks	5-23
5.7.5.4	Displaying only the marks registered during the specified period.....	5-24
5.8	Setting a route.....	5-25
5.8.1	Setting a route directly on the map	5-25
5.8.1.1	Checking the route that was set.....	5-25
5.8.2	Creating a route by connecting marks	5-26
5.8.3	Editing a route.....	5-27
5.8.3.1	Adding a waypoint on the map	5-27
5.8.3.2	Deleting a waypoint	5-28
5.8.4	Deleting a route.....	5-28
5.8.4.1	Deleting a route by selecting from the [Routes] list.....	5-28
5.8.4.2	Deleting all the routes.....	5-29
5.8.5	Other operations relating to route	5-29

5.8.5.1	Displaying a specified route on the map	5-29
5.8.6	Creating a temporary route	5-29
5.8.6.1	Canceling route navigation by using a temporary route	5-30
5.8.7	Creating a temporary destination	5-30
5.8.7.1	Canceling route navigation to a temporary destination	5-30
5.9	Starting/ending route navigation	5-30
5.9.1	Starting route navigation	5-30
5.9.1.1	Starting route navigation on the map	5-30
5.9.1.2	Starting route navigation from the route list	5-31
5.9.1.3	Map screen during route navigation	5-31
5.9.1.4	Navigation alarms	5-31
5.9.2	Operating a route	5-32
5.9.2.1	Skipping a waypoint	5-32
5.9.2.2	Re-setting a cross-track error	5-32
5.9.3	Ending route navigation	5-32
5.9.3.1	Ending route navigation by using a menu	5-32
5.9.3.2	Ending route navigation by using a key	5-32
5.10	Switching a map	5-33
Section 6 How to Use Various Screens		6-1
6.1	Customizing screens	6-3
6.1.1	Customizing a data bar	6-3
6.1.1.1	Setting a data bar (layout)	6-3
6.1.1.2	Setting a data bar	6-4
6.1.2	Split display by adding a screen	6-5
6.1.2.1	Deleting a screen	6-5
6.1.3	Replace with another screen	6-5
6.1.4	Moving a boundary of a split display screen	6-6
6.1.5	Setting an undisplay screen	6-6
6.1.6	Saving the screen that is currently displayed	6-7
6.2	Highway screen	6-7
6.2.1	Information that is displayed on a highway screen	6-7
6.3	Data screen	6-8
6.3.1	Customizing a data screen	6-8
6.3.1.1	Switching a layout of a data screen	6-8
6.3.1.2	Setting display information of each gauge	6-9
6.4	Sonar screen	6-10
6.4.1	Information displayed on a sonar screen	6-10
6.4.2	Using a sonar screen	6-11
6.4.2.1	Switching a range	6-11
6.4.2.2	Displaying sonar screens of two frequencies	6-11
6.4.2.3	Changing the setting of a sonar screen	6-12
6.5	Video screen	6-12

6.5.1	Setting the equipment according to the input signals	6-12
6.5.1.1	Setting the equipment according to the image signaling system	6-12
6.5.1.2	Setting the equipment according to the input signal type.....	6-12
6.5.2	Adjusting an image quality.....	6-13
6.6	Satellite information screen.....	6-13
6.6.1	Information that is displayed on the satellite information screen.....	6-13
6.6.1.1	Checking data received from a GPS receiver	6-14
6.7	Tide table screen.....	6-14
6.7.1	Information displayed on a tide table screen	6-14
6.7.1.1	Bringing a date forward/backward.....	6-15
6.7.1.2	Moving the time cursor/tide level cursor.....	6-15
6.8	AIS numeric information screen.....	6-15
6.8.1	Information displayed on the AIS numeric value display screen	6-15
6.8.1.1	Checking detailed information	6-16
6.8.1.2	Checking a received message	6-16
6.8.1.3	Checking an AIS target position on the map on the map	6-16
6.8.1.4	Sorting AIS targets.....	6-17
6.9	DSB information screen	6-17
6.9.1	Information displayed on a DSB information screen	6-17
6.9.1.1	Displaying other ship at the center of the map.....	6-18
6.10	NAVTEX screen	6-18
6.10.1	Information displayed on a NAVTEX screen.....	6-18
6.10.1.1	Checking a message text on a large window	6-19
6.10.1.2	Reloading messages.....	6-19
6.10.1.3	Deleting a message.....	6-19
6.10.1.4	Deleting all the messages	6-19
Section 7	Function Menus.....	7-1
7.1	Map screen menu	7-2
7.1.1	How to set the [Create waypoint] screen.....	7-6
7.2	Highway screen menu.....	7-7
7.3	Data screen menu.....	7-8
7.4	Sonar screen menu.....	7-9
7.5	Video screen menu	7-12
7.6	Tide table screen menu.....	7-13
7.7	AIS numeric value information screen menu	7-14
7.8	DSB information screen menu	7-15
7.9	NAVTEX screen menu	7-16
Section 8	System Configuration Menus.....	8-1
8.1	Setting general operation—System Configuration Menu.....	8-1
8.2	Setting display of own ship and so on—Own ship menu.....	8-4

8.3	Setting chart display—Chart menu	8-7
8.4	Setting a sonar screen—Sonar menu	8-13
8.5	Setting GPS—GPS menu	8-15
8.6	Setting tracks and logs—Track & Log menu	8-17
8.7	Setting communication—Comms menu	8-19
8.8	Setting AIS information—AIS menu	8-21
8.8.1	Setting a special target	8-23
8.9	Setting ARPA(TT)—ARPA(TT) menu	8-24
8.10	Setting DSB—DSB(TT) menu	8-26
8.11	Setting GPS buoy—GPS Buoy menu	8-27
8.12	Setting alarms—Alarms menu	8-28
8.13	Saving and calling settings—Memory menu	8-32
8.14	Setting others—Others menu	8-36
Section 9	Setting and Executing Shortcuts	9-1
9.1	Marks and functions that can be set	9-1
9.1.1	Marks that can be set	9-1
9.1.2	Functions that can be set	9-2
9.2	Setting marks and functions	9-4
9.2.1	Setting a mark	9-4
9.2.2	Setting functions	9-4
9.2.2.1	Setting an ARPA track display function	9-4
9.2.2.2	Setting a screen switching function	9-5
9.2.2.3	Setting a chart level switching function	9-5
9.2.2.4	Setting various display functions	9-6
9.3	Executing shortcut	9-7
9.3.1	Registering a mark	9-7
9.3.1.1	Registering a mark in the own ship's position	9-7
9.3.1.2	Registering a mark in the cursor position	9-7
9.3.2	Switching an ARPA track display to On/Off	9-7
9.3.3	Switching a screen	9-7
9.3.4	Switching a chart level	9-8
9.3.5	Displaying various screens	9-8
Section 10	Maintenance and Inspection	10-1
10.1	General maintenance and inspection	10-2
10.2	Troubleshooting	10-3
Section 11	After-Sales Service	11-1
11.1	Guarantee	11-1
11.2	Service parts retention period	11-1
11.3	Requesting for repair	11-1

11.4	Recommendation of regular inspection and maintenance.....	11-2
Section 12	Disposal.....	12-1
12.1	Disposal of this equipment.....	12-1
12.2	About Chinese version RoHS	12-2
Section 13	Specifications.....	13-1
13.1	Function specification.....	13-1
13.2	Power Supply specification	13-3
13.3	Environment conditions.....	13-3
13.4	External dimension and weight.....	13-3
Section 14	Appendix/Reference Materials.....	14-1
14.1	Function menu table.....	14-2
14.1.1	Map screen menu	14-2
14.1.2	Highway screen menu	14-3
14.1.3	Data screen menu.....	14-4
14.1.4	Depth screen menu.....	14-5
14.1.5	Video signal menu	14-6
14.1.6	Tide table screen menu	14-6
14.1.7	AIS numeric information screen menu.....	14-7
14.1.8	DSB information screen menu.....	14-7
14.1.9	NAVTEX screen menu	14-7
14.2	System Configuration menu table.....	14-8
14.3	Data output format	14-22
14.3.1	Output sentence format	14-22
14.4	Index.....	14-27

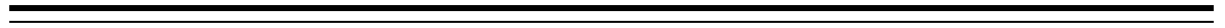

PREFACE

Thank you for purchasing the JLZ-1000 color plotter.

When connected to a GPS/DGPS receiver and a GPS navigation system, this color plotter can plot tracks of own ship continuously along with latitude/longitude lines and scale lines.

- Before using this equipment, please read this manual carefully to ensure proper use.
- Store this instruction manual carefully for future reference.



Please use this manual to clarify any questions arising or investigate any failures that occur while using this equipment.

● Pictorial Marks Used in This Manual ●

Meanings of Pictorial Marks

Pictorial marks are used in this instruction manual and on the product to ensure correct handling of the product and defend you and others' safety and assets.

Their meanings are explained below. Fully understand these meanings before starting to read the manual.

 DANGER	This indication is shown where any person may be placed in imminent danger of death or seriously injury, if this indication is neglected and this equipment is not operated correctly.
 WARNING	This indication is shown where any person may be killed or seriously injured if this indication is neglected and this equipment is not operated correctly.
 CAUTION	This indication is shown where any person may be injured or any property damage may occur if this indication is neglected and this equipment is not operated correctly.

Examples of Pictorial Indication



Electric Shock

The △ mark represents CAUTION (including DANGER and WARNING).

Detailed contents of CAUTION ("Electric Shock" in the example on the left) is shown in the mark.



Disassembling
Prohibited



The ⊘ mark represents prohibition.

Detailed contents of the prohibited action ("Disassembling Prohibited" in the example on the left) is shown in the mark.



Disconnect
the power plug



The ● mark represents instruction.

Detailed contents of the instruction ("Disconnect the power plug" in the example on the left) is shown in the mark.

Warning Label



A warning label is attached at the top of the cover of the processing unit.

Do not try to remove, break or modify the label.

● Precautions upon Equipment Operation ●

DANGER



Never remove the cover of this equipment.
Touching the high-voltage section inside will cause an electric shock.



Always turn off the power supply switch and disconnect the circuit breaker before implementing inspection, maintenance, part replacement, or for care and cleaning of this equipment.

Otherwise, an electric shock, fire, or malfunction may occur.



Do not touch the equipment with hands or gloves wet with water.

Otherwise, an electric shock or a malfunction may occur.

WARNING



Do not disassemble or remodel this equipment. Otherwise, an electric shock, fire, or malfunction may occur.



Do not wet or pour water into this equipment. Otherwise, an electric shock, fire, or malfunction may occur.



Do not use this equipment at any voltage other than the supply voltage stated on the equipment. Otherwise, an electric shock, fire, or malfunction may occur.



Do not scratch, damage, or modify the power cord. If a heavy object is placed on the cord or the cord is heated, pulled, or forcibly bent, the cord will be broken resulting in fire or an electric shock.



Never attempt to check or repair the inside of the equipment. Inspection and repair by anyone other than specialized engineers may result in fire, an electric shock, or malfunction.



Please request internal inspection and repair to JRC or a JRC distributor.



Before removing or inserting the cable connector to peripheral equipment, be sure to turn off the power. Use with the cable connector connected may cause fire or an electric shock.



When any abnormality such as smoke, unusual odor, or unusually high temperature is detected, turn off the switch immediately and remove the power cable. Then contact JRC or your dealer. Continuing operation as is may cause fire or an electric shock.



Do not operate this equipment during navigation. Otherwise a maritime accident may occur.



Always disconnect the power cable from the processing unit when setting a resolution of the monitor. Otherwise, fire, an electric shock, or malfunction may occur.

Notes on using the new pec chart

WARNING



When an SD card of the new pec chart is inserted and the map setting is set to new pec, new pec data is displayed.

Do not insert or remove the SD card while the equipment is used.

Otherwise, a failure, a malfunction, or an injury may be caused.



When extended contour data is recorded in the chart data, detailed contour lines can be displayed.



Extended contour line ON



Extended contour line OFF

On the normal new pec chart line, 10m and 5m are clearly color coded. However, when the extended contour line display is set to On, they are no longer color coded. When the chart is used for navigation guideline, it is very dangerous to use the chart by setting the “extended contour line ON” as shallow water depths are not clearly color coded. Do not set the extended contour line display to ON except for the judgement of approximate undulation of the sea floor for fishing and so on.

An incorrect use may cause serious accident. Utmost care is necessary.

CAUTION



Do not use this equipment in any environment other than that indicated in the specification.
Otherwise, a failure, a malfunction, or a personal injury may occur.



As all the DIP switches that are installed in the unit are set at the factory, the settings definitely must not be changed.
Otherwise, a failure, a malfunction, or a personal injury may occur.



Do not install this equipment in the place that may be splashed by water, oil, or chemical.
Otherwise, a failure, a malfunction, or a personal injury may occur.



Do not place this equipment in the place under server vibration or impact.
The equipment may drop or fall down, resulting in a failure or a personal injury.



Do not place any item on this equipment.
Otherwise, a failure, a malfunction, or a personal injury may occur.



Do not place this equipment in an unstable place such as on an unstable stand or on a slope. The equipment may drop or fall down, resulting in a personal injury.



When installing this equipment, fix the stand on to the hardwood plate by using the specified screws.
Without this measure, this equipment may drop, resulting in a personal injury or property damage.



Installation construction of this equipment must not be carried out by any party other than JRC or a distributor of JRC.
Installation carried out by anyone other than the specialized engineers may result in a malfunction.



Use the specified fuses only.
Use of any other fuses may result in fire or a failure.

CAUTION



This equipment is intended for use as an aid to navigation only.

- The information that is displayed by using through this equipment may not directly fulfill the purpose of navigation.
Use a formal chart for navigational judgments.
- This equipment does not automatically make judgements on position information.
Such judgements must always be made by the operator of the ship.



If an incorrect value is entered, the latitude and longitude of the own ship's position or the cursor position are not converted to a time difference or LOP correctly. This may result in incorrect position confirmation, causing an accident. Always check that correct values are input. Check also that the converted values are correct.



When a latitude or a longitude is corrected, the own ship's position or the numeric value is displayed, by shifting from the actual position. To prevent any accident, check the surrounding of the ship and operate the ship, by keeping this shift in mind.

SD card and USB memory stick

WARNING



Do not attempt to disassemble or tamper with this equipment.
Otherwise, fire, an electric shock, or a failure may occur.



Do not wet an SD card or a USB memory stick with water, and so on.
Otherwise, fire, an electric shock, or a failure may occur.



Do not place a heavy item on an SD card or a USB memory stick or apply a strong impact.
Otherwise, a failure may occur.

CAUTION



Do not store or use an SD card or a USB memory stick in any of the following places (environment).

Otherwise, a failure or a malfunction may occur.

- Place that is exposed to direct sunlight
- Place of high humidity or dust content
- Near an item that generates heat (such as heater or stove)
- Near an item that generates strong magnetic radio waves (such as magnet, speaker, or radio unit)
- Place that generates static electricity



Insert an SD card or a USB memory stick straight in the correct direction.

Otherwise, a failure or a malfunction may occur.

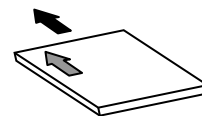

To clean an SD card or a USB memory stick, wipe it with a dry soft cloth gently. Do not use thinner or benzene.

Otherwise, a failure or a malfunction may occur.



Always store them in their attached case after using.

Otherwise, a failure or a malfunction may occur.

EQUIPMENT APPEARANCE

Operation Unit



Processing Unit



List of abbreviations

This section describes the main abbreviations that are used for this equipment and related general nautical terms.

AC	Alternating Current	交流
AED	Automated External Defibrillator	自動体外式除細動器
ANT	Antenna	アンテナ
BLU	Blue	青
bps	bits per second	ビット／秒
COG	Course Over the Ground	対地針路
DC	Direct Current	直流
DGPS	Differential GPS	相対 GPS 測位方式
FAT	File Allocation Table	ファイル・アロケーション・テーブル
G	Standard Acceleration of Gravity	標準重力
GND	Ground	地面
GNSS	Global Navigation Satellite System	全地球ナビテーション衛星システム
GPS	Global Positioning System	全地球測位システム
GRN	Green	緑
HDOP	Horizontal Dilution of Precision	幾何学的精度低下率
HSYNC	Horizontal Synchronization	水平同期
ICD	Implantable Cardioverter Defibrillator	植え込み型除細動器
ID	Identification	識別名
IEC	International Electrotechnical Commission	国際電気標準会議
kn	knot	ノット
NMEA	National Marine Electronics Association	米国海洋電子機器協会
No.	Number	番号
RX	Receive/Receiver	受信／受信機
SBAS	Satellite-based Augmentation System	静止衛星型衛星航法補強システム
SOG	Speed Over the Ground	対地速度
SW	Switch	スイッチ
TEMP	Temperature	温度／水温
TX	Transmit/Transmitter	送信／送信機
VSYNC	Vertical Synchronization	垂直同期

Terminology

This section describes the main terms used for this equipment.

IEC 60945	Navigation system and radio equipment in general – IEC performance requirements
RS422	Technical standard for defining electrical characteristics of balanced digital interface circuits
S-VIDEO	System for transmitting composite video signals by separating them into two types, brightness signals and color signals
SVGA	Super Video Graphics Array Image resolution: 800x600 pixels
XGA	Extended Graphics Array Image resolution: 1024x768 pixels

How to Use This Manual

Structure of this manual

This manual is structured as shown below.

Be sure to read the “Safety Cautions”, “Emergency Measures”, “Preface”, “Pictorial Marks Used in This Manual”, and “Precautions upon Equipment Operation” items. Read the other items for necessary sections as required.

Item	Contents
Safety Cautions Emergency Measures	Describes the cautions for a high voltage, precautions for rescue of victims of an electric shock, and the method of First-Aid treatment.
Preface	Describes the purposes of using this equipment.
Pictorial Marks Used in This Manual Precautions upon Equipment Operation	Describes the safety precautions and warning on this equipment.
Equipment Appearance	Describes the appearance of this equipment.
How to Use This Manual	This page
Section 1 Overview of the Equipment	Describes the overview of this equipment.
Section 2 Name and Function of Each Unit	Describes the name and function of each unit of this equipment.
Section 3 Installation	Describes the procedure for installing this equipment by JRC or a distributor of JRC and the cable specification.
Section 4 Basic Operation	Describes the procedure for the common screen operations such as power On/Off and map screens and outline of setting through menus.
Section 5 Map Screen Operating Procedure	Describes how to operate the map screen, setting destinations and routes on the map screen, and how to use them.
Section 6 How to Use Various Screens	Describes the procedure for customizing the screen display according to the purpose and describes the screens other than the map screen.
Section 7 Function Menus	Describes all the items in the function menu specific to each screen.
Section 8 System Configuration Menus	Describes all the items in the system configuration menus.
Section 9 Setting and Executing Shortcuts	Describes the procedure for assigning specific marks and functions to numeric keys of this equipment and using the keys as shortcut keys.
Section 10 Maintenance & Inspection	Describes the maintenance and inspection of this equipment.
Section 11 After-Sales Service	Describes the aftersales service of this equipment.
Section 12 Disposal	Describes the cautions on disposing of this equipment.



Item	Contents
Section 13 Specifications	Describes the main specifications of this equipment.
Section 14 Appendix and Reference Materials	Provides reference materials such as a menu list.



Notations

Keys and switches of the operation unit are represented as shown below.

Types of keys and switches	Notation
Switch with name	The switch name is indicated by enclosing with []. Example: [POWER] switch
Pictorial key	Expressed as follows. Example:  (Mark) key

The buttons and menu items that are displayed on screens are represented as shown below.

Types of buttons and menus	Notation
Page menu*1 button	Represented as follows. Example:  →[Route] button Example:  →[Screen addition] button (See the description of “Page menu buttons” at the beginning of Section 6.)
Menu item	Represented by enclosing with []. Example: [New route]

*1: Menu that is displayed when the  (Active screen) key or the  (Screen) key is long-pressed.

Section 1 Overview of the Equipment

1.1 Functions

- By connecting with the GPS/DGPS receiver or GPS navigation system, this equipment continuously plots the tracks of own ship in color together with latitude and longitude lines, and scales.
- This equipment can display and erase tracks by changing the color of the tracks freely. This function is very useful as it enables users to identify the movements of operations intuitively.
- This equipment records destinations and passing points (using marks such as dangerous position, shoal, fish reef position, and so on) and displays them in color.
- This equipment can automatically display the distance and bearing from the current position that changes constantly.
- This equipment can freely expand, reduce, and move a display sea area, thereby being useful for various applications.

1.2 Features

This equipment has the following features.

High speed and accurate display of electronic reference chart “NAVIONICS®+”

NAVIONICS®+ covers the entire world area, by replacing the SD card in each area, this equipment is capable of accurate display of resolution XGA at high speed, under which users do not feel any stress.

Variety of additional functions and displays

The equipment is capable of a variety of displays with its variety of additional functions. As the display is in a separate configuration, the size can be selected.

Capable of displaying up to four split screens

- Analogue meter display of engine fuel information by connecting NMEA2000
- Simple display (water depth value and image) by connecting a transducer
- Highway (CDI) display by specifying a destination
- Display of monitored images by connecting an external camera (CCTV: 2 inputs/S-Video: 1 input)

Displaying character information

AIS and NAVTEX display

Merging old operability and new operability:

This equipment enables operation and display switching of the new functions while using the layout of the popular current keys.

- Color switching by using the display color switch and single-touch mark input
- Operation with left and right button clicking sensations in addition to the cursor movement by the trackball
- Allowing allocation of any operations to the function keys

1.3 Configuration

Standard configuration

NCM-971 Control unit

	Item name	Model (code)	Q'ty	Remarks
1-1	Processing unit	NDC-1752	1	
1-2	Power supply cable	CFQ-7516	1	3m
1-3	Spare fuse	51NR 2 05000 51NR 2 07000	2	250V/5A: 1 (φ5x20mm) 250V/7A: 1 (φ5x20mm)
2-1	Operation unit	NCH-748	1	
2-2	Velcro tape	MTZ302573	2	For operation unit
2-3	Flush-mount kit	MPTG31340	1	For operation unit
3-1	Instruction manual	7ZPNA4661	1	
3-2	Simple operation guide	7ZPNA4663	1	

NWZ-157-J/NWZ-211 Display unit

For the components and optional items, check with the Instruction Manual that is included in the product.

Options

	Item name	Model (code)	Q'ty	Remarks
1	GPS receiver	JLR-4340	1	
2	DGPS receiver	JLR-4341	1	Built-in beacon receiver
3	GPS connection cable	CFQ-9000	1	15m
4	Map card	CDD-812	1	new pec (Japanese only)
5	Operation unit mounting metal fitting kit	MPXP32938	1	
6	MEDIA cable	CFQ-7517	1	1m
7	GPS antenna	NAY-1200	1	With TNC connector, 15m cable
8	Transducer	CFT-2505KZ	1	200k/50kHz 600W
		CFT-2510KZ	1	200k/50kHz 1kW

1.4 Structure

1.4.1 NCH-748 operation unit

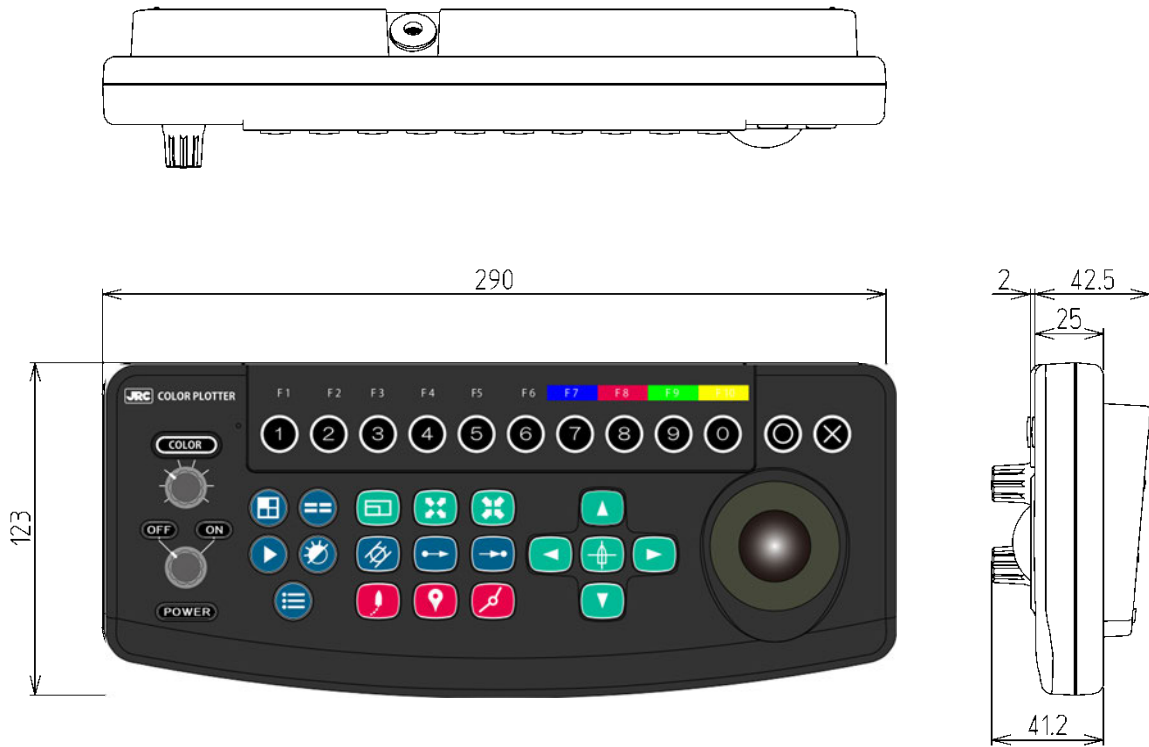

Size: 290 x 123 x 42.5 mm
Weight: About 1.1 kg

1.4.2 NDC-1752 processing unit

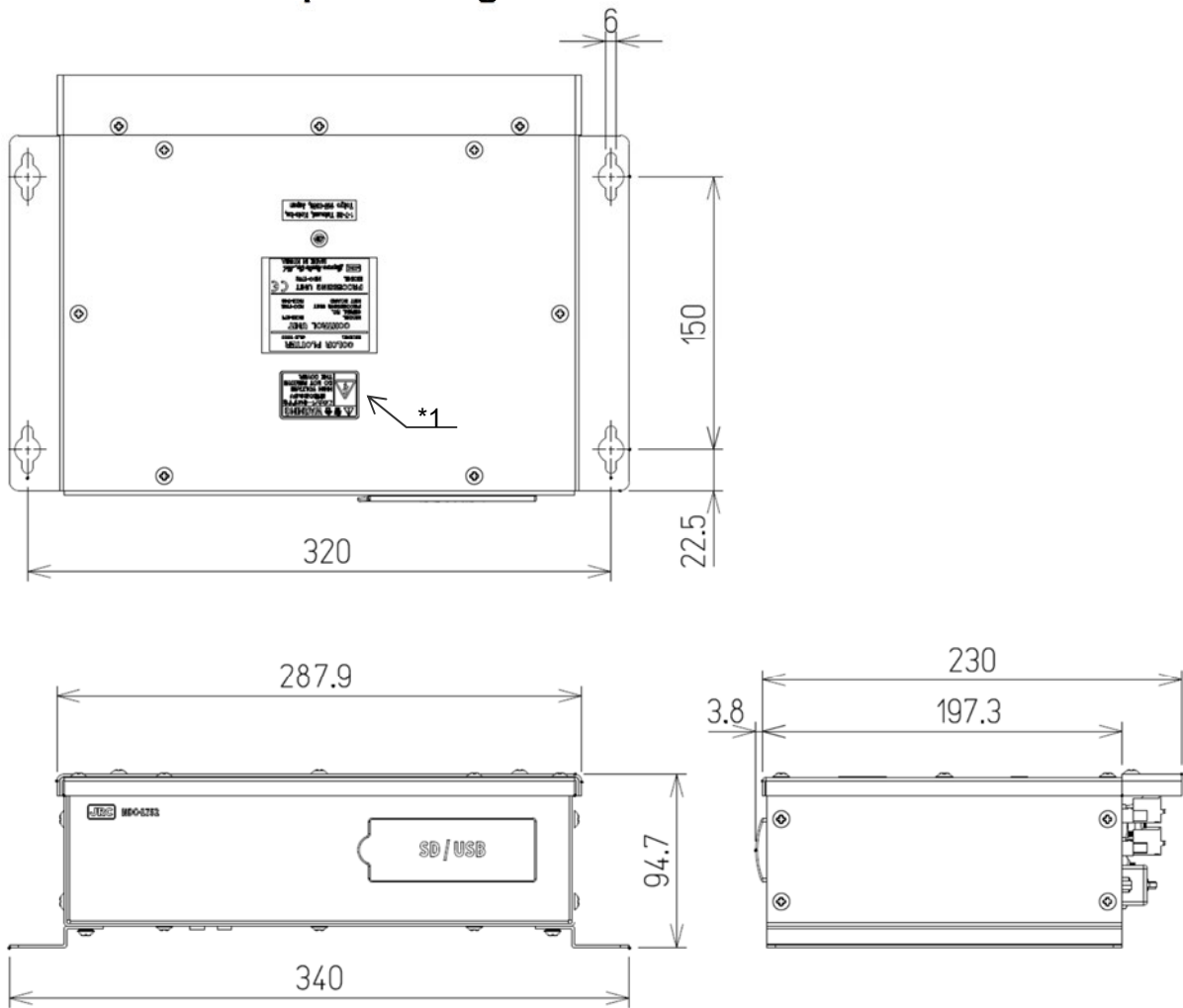

Size: 340 x 233.8 x 94.7 mm
Weight: About 2.2 kg

*1 Warning nameplate



1.5 Comprehensive system diagram

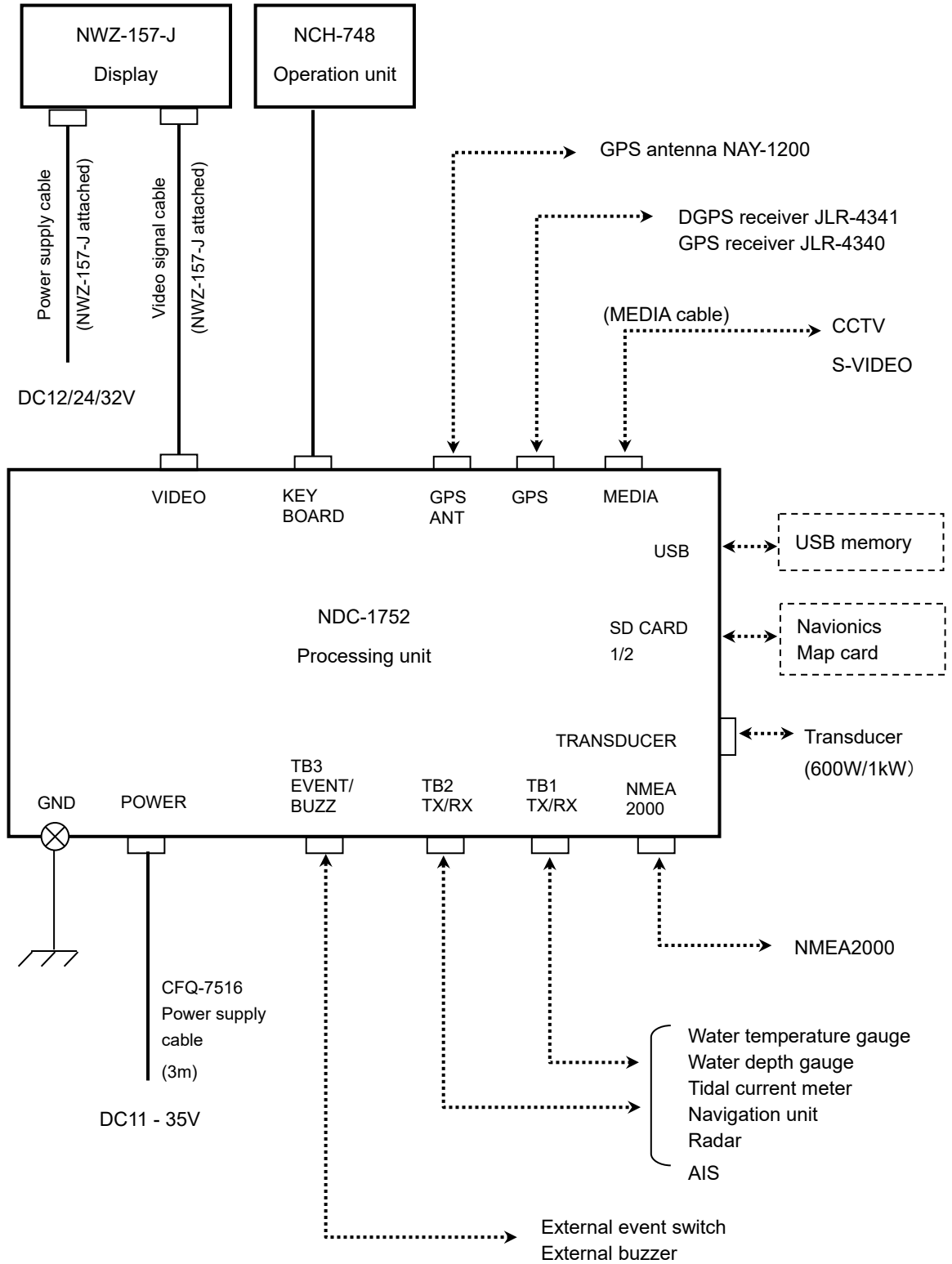

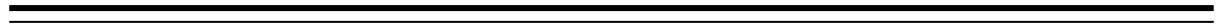





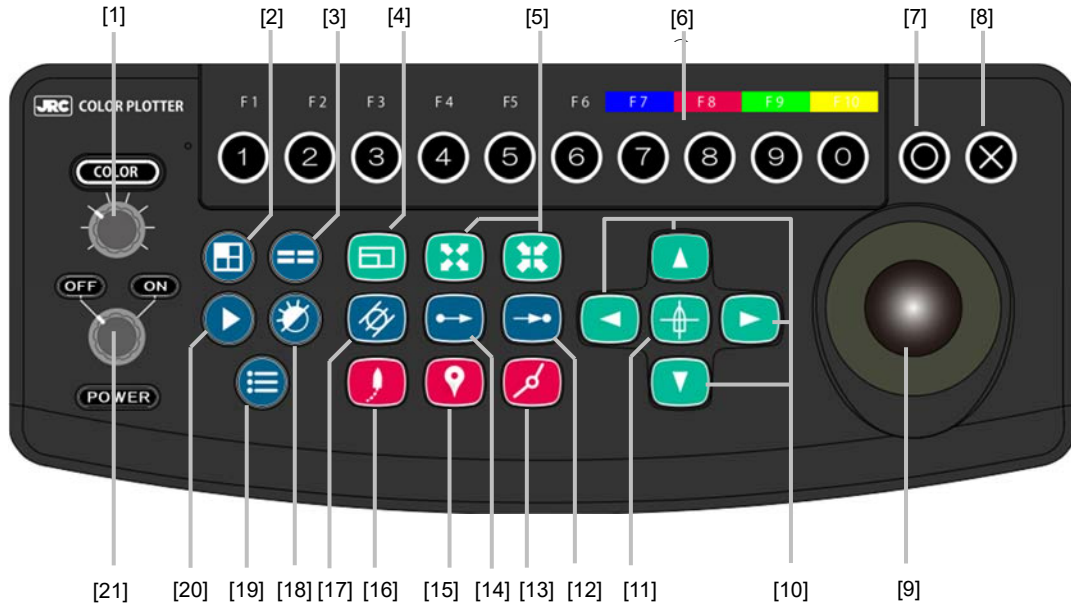



Section 2 Name and Function of Each Unit

2.1 NCH-748 operation unit



No.	Keys and others		Function	
			Normal operation	Holding down
1	[COLOR]	Colour display	Select a mark or track color by turning it to the left or the right.	
2		Active screen	Switches the active screen on a split screen.	Displays the page menu
3		Data bar	Switches the pattern of the data bar.	Customizes the data bar.
4		Preset scale	Expands/reduces the preset scale.	Sets preset.
5		Expand/reduce	Expands/reduces the displayed map.	Expands/reduces the displayed map continuously.
6		Numeric value	Enables input of numeric values/calls a shortcut function.	Registers the shortcut function.
7		Determine	Determines the selection.	-
8		Return	Cancels/returns to the previous operation.	-
9	Trackball		Moves the cursor on the map screen.	
10		Up/Down/Left/Right	Moves the map/moves and sets the menu item.	Moves the map continuously.
11		Center	Displays own ship or the cursor position at the center/determines the selection.	Switches the bearing mode.

No.	Keys and others		Function	
			Normal operation	Holding down
12		End point	Sets the end point of the temporary route or temporary destination.	-
13		Route	Starts route navigation.	Registers a new route.
14		Starting point	Sets a waypoint of the temporary route.	-
15		Mark	Switches the mark color.	Registers a mark on the own ship's position.
16		Track	Switches the track color.	Displays the [Tracks] menu.
17		Variable cursor	Displays a variable cursor on the own ship's position/sets a variable cursor display to Off.	Displays a variable cursor on the crosshair cursor position/sets a variable cursor display to Off.
18		Day/Night	Switches the day/night mode.	Saves the screen that is currently displayed.
19		Menu	Displays the function menu of the active screen.	Displays a system setting menu.
20		Screen	Switches the main screen.	Displays a page menu.
21	[POWER]	Power supply	Turns on/off the power supply of the equipment.	

2.2 NDC-1752 processing unit

Front

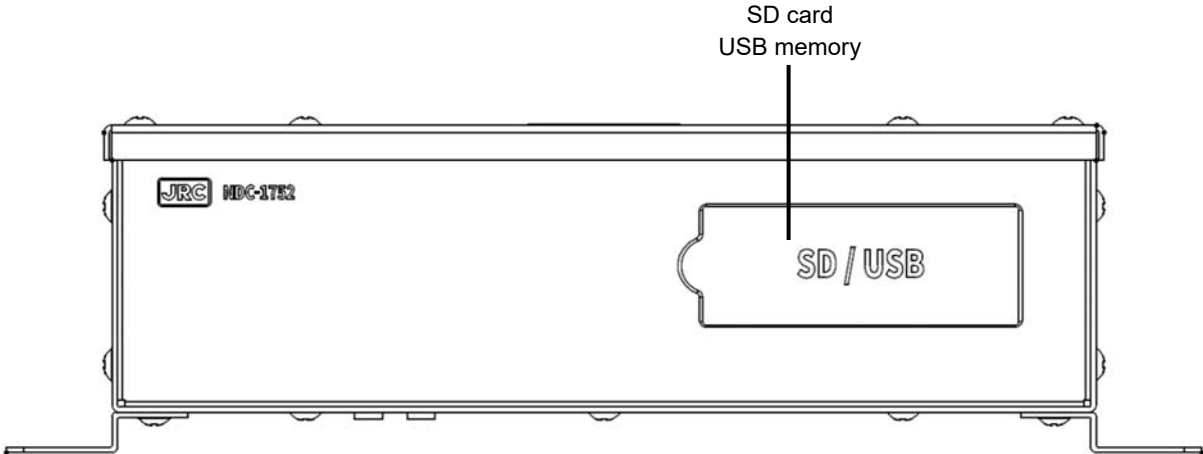

Back

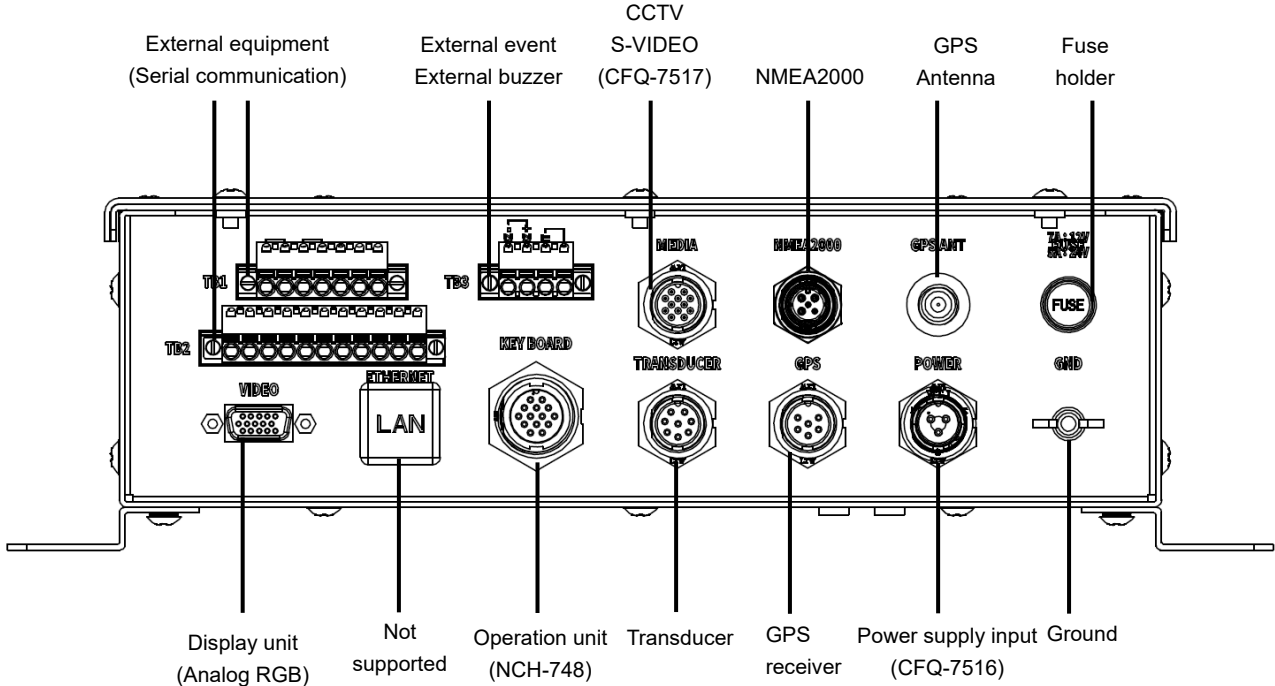



Section 3 Installation

CAUTION



This equipment must not be installed by any party other than JRC and agents of JRC.

Installation that is carried out by anyone other than specialized maintenance staff may result in an operation fault.

3.1 Installing the equipment

3.1.1 Installing the processing unit

3.1.1.1 Selecting an installation location

For floor-mounting installation, it is recommended to install in the following area.

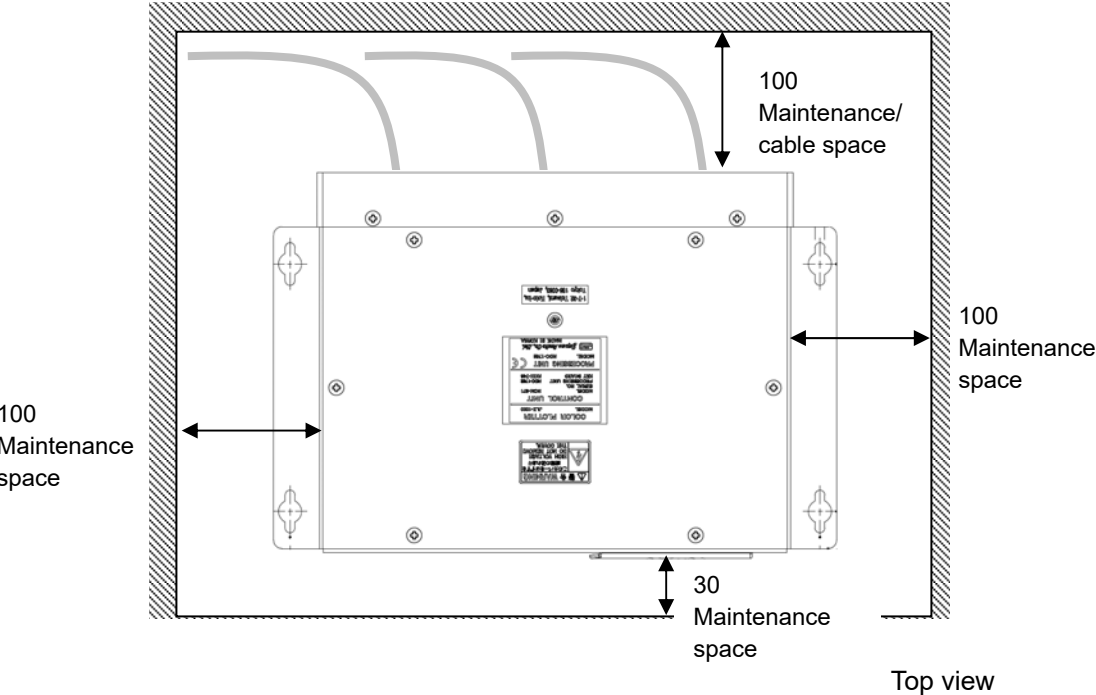

Top view

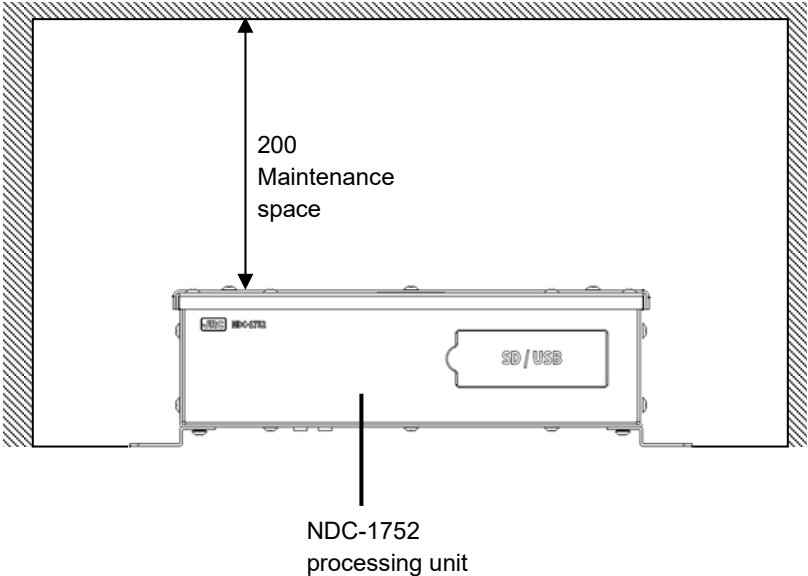

Front view

NDC-1752 processing unit

Unit: mm

3.1.1.2 Floor-mounting installation

Fix the equipment according to the following procedure.

- 1 Make screw holes on the area where the equipment is to be installed.
- 2 Fix the equipment by using screws.

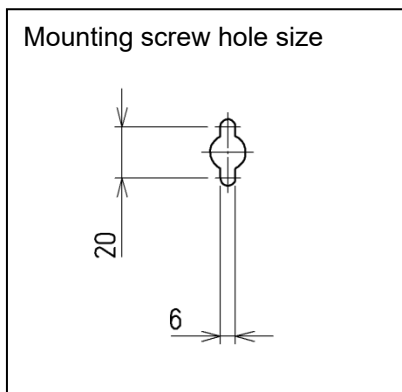
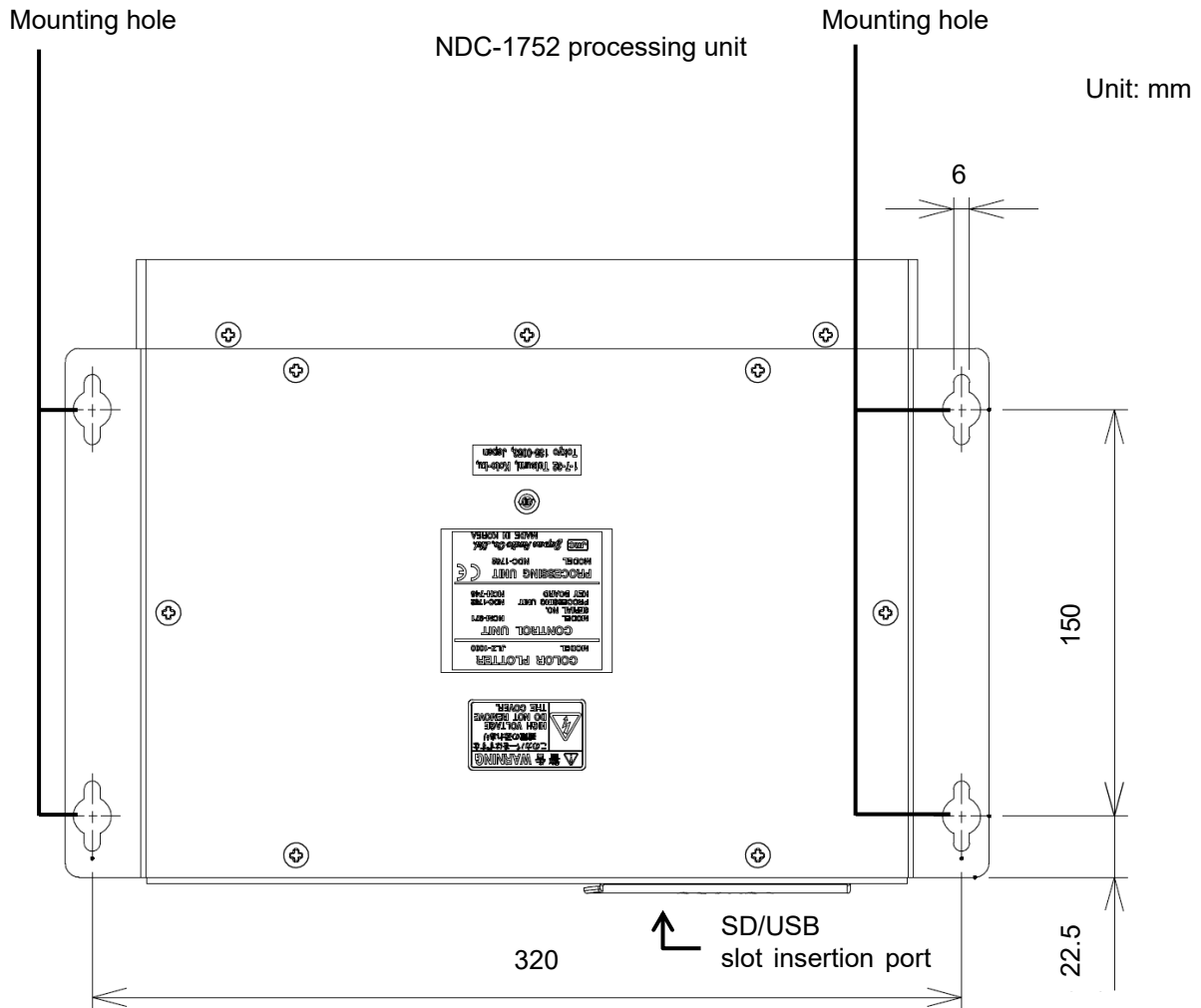

3.1.1.3 Wall-mounting installation

For wall-mounting installation, it is recommended to mount the SD/USB slot facing the ceiling.

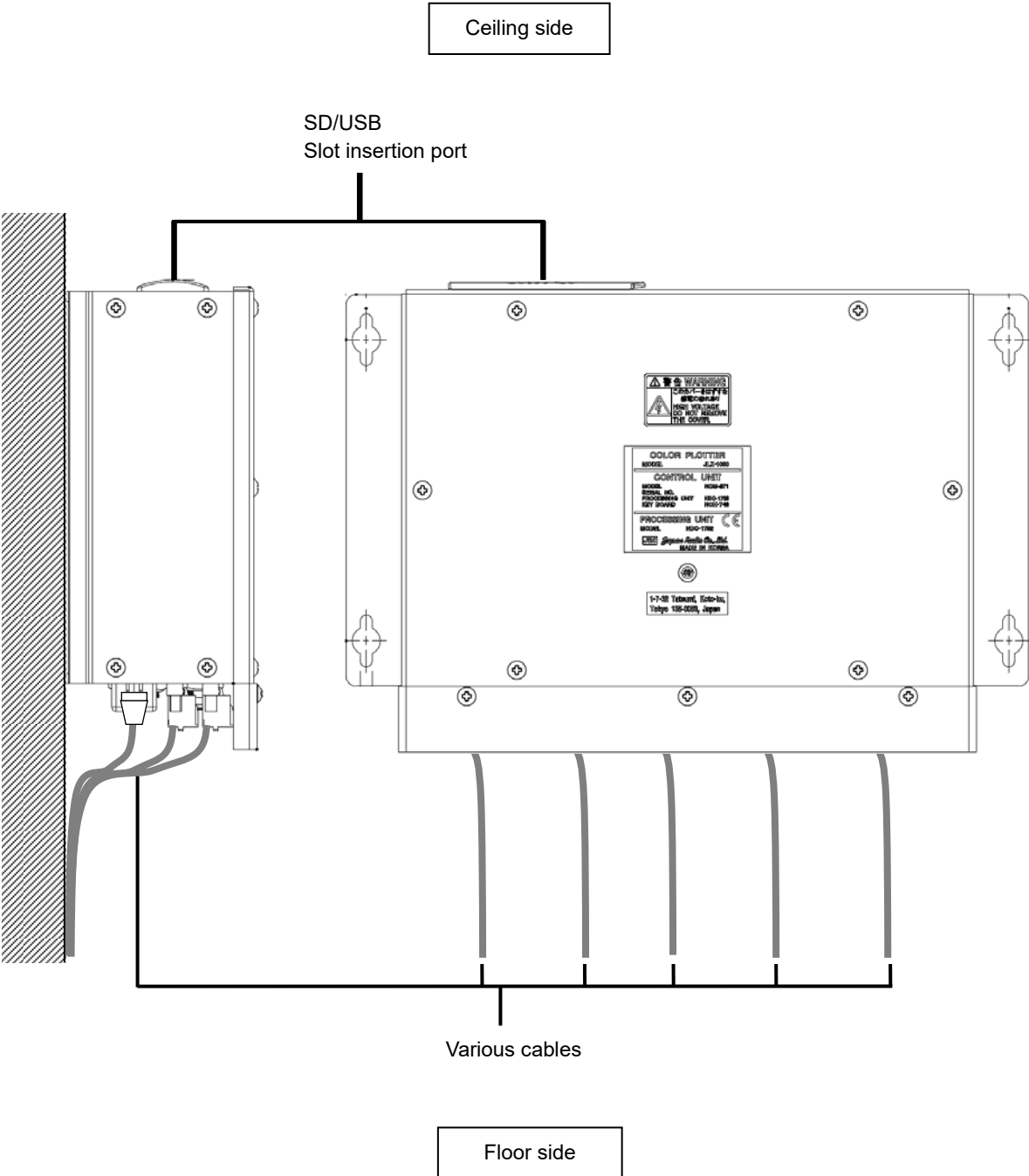

3.1.2 Installing an operation unit

Fix the equipment according to the following procedure.

- 1 Attach one side of the Velcro tape on the equipment.**
- 2 Attach the Velcro tape of the opposite side, matching the Velcro tape on the equipment.**
- 3 Remove the paper from the Velcro tapes and attach the equipment on the structure of the ship.**

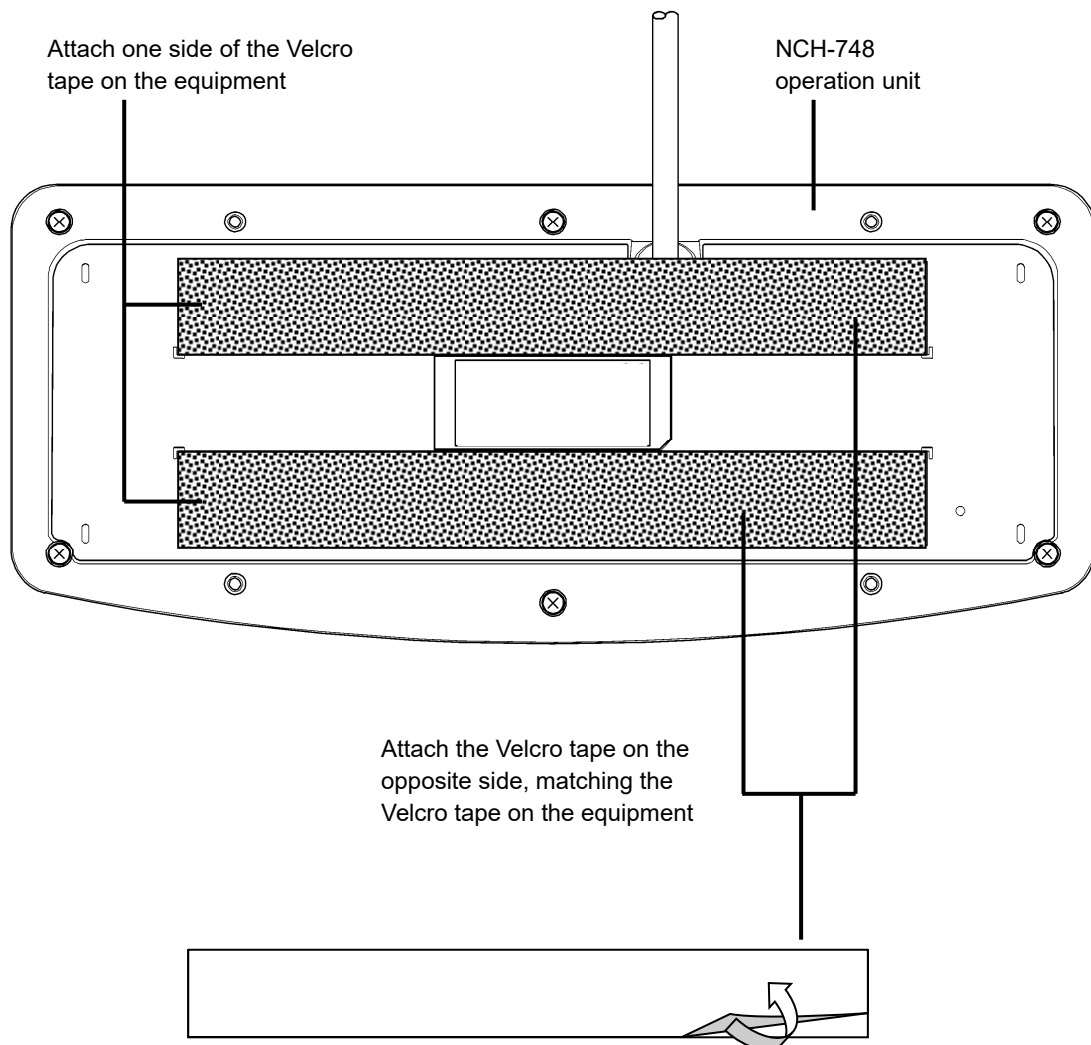

Remove the paper from the Velcro tapes and attach the equipment on the structure of the ship.

Flush-mounting installation

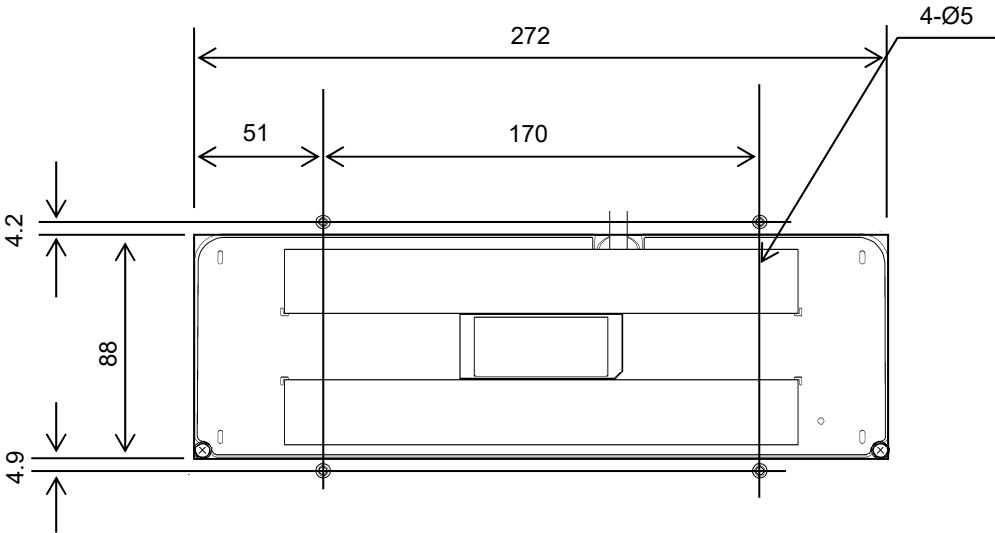

Unit: mm

3.2 Connecting cables

Connecting a power supply cable

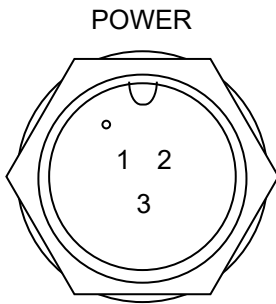

Power supply cable: CFQ-7516 (attached)

Pin number	Name		Description
1 (White)	Power supply input	DCIN +	Connect the attached power supply cable. The power voltage distance is 11V to 35VDC.
2 (Black)		DCIN-	
3 (Green)		GND	

In this equipment, overvoltage protection functions at the input voltage distance from 35VDC to 36VDC and the power supply is turned off.

When the input voltage returns to the operating voltage distance, the overvoltage production is reset and this equipment restarts.

Note

When 40VDC or more is applied to the input pin, this equipment may be damaged.

Appearance of the connection cable

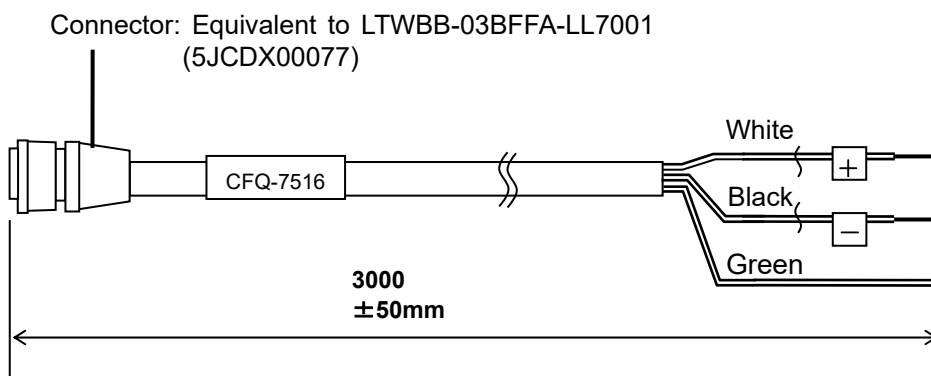

Connector diameter: ϕ 20mm or less

Cable diameter: ϕ 8mm or less

Connecting GND

GND



Thumbscrew for fixing a full ground wire
Size: M4 screw

- The processing unit must be connected to the ground of the ship's structure for the continuous stable operation.
Connect to the ground of the ship's structure from the fixing thumbscrew.
- Connect by mounting a crimped terminal suitable for the cable.
- The following cable is recommended.

Item name	Model	Manufacturer
Ground wire	Equivalent to UL1015TEW 1X10AWG(104/0.26)LF5 Midori PBF	Equivalent to Hitachi Metals (formerly Hitachi Cable)

Connecting a keyboard cable

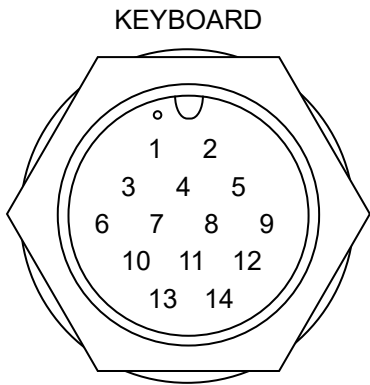

Keyboard cable: Install in NCH-748

Pin No.	Name		Description
1	Power supply On/Off	SW1	Signal for turning on/off the power supply
2		SW2	
3	GND		
4	Unused		
5			
6			
7	Data	TXD232	Processing unit → Operation unit
8	Unused		
9	Data	RXD232	Processing unit ← Operation unit
10	Unused		
11	+12V		Power supplied from the processing unit to the operation unit
12			
13	GND		
14			

Appearance of connection cable



Connecting a video signal cable

VIDEO

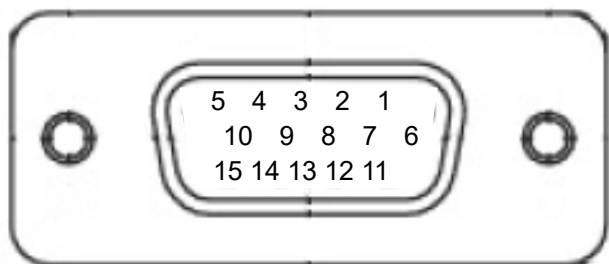

Pin No.	Name		Description
1	Red	RED	Outputs a video red signal
2	Green	GRN	Outputs a green video signal
3	Blue	BLU	Outputs a blue video signal
4	Unused		
5	GND		
6	GND		
7	GND		
8	GND		
9	Unused		
10	GND		
11	Unused		
12	Unused		
13	Horizontal synchronous	HSYNC	Outputs a horizontal synchronous signal
14	Vertical synchronous	VSYNC	Outputs a vertical synchronous signal
15	Unused		

Fix a video signal cable by firmly tightening both sides of the connector.

Note

If the cable moves due to vibrations, the connector and cable are stressed. Since this may result in disconnection of the cable, firmly fix the cable with a clamping band.

At the factory delivery, the monitor resolution is set to XGA (1024 x 768 pixel). When changing the resolution to SVGA (800 x 600 pixel), refer to the following page.

Monitor resolution setting procedure

Note

Before changing the resolution, remove the power supply cable from the processing unit.

- 1 Open the cover of the processing unit (remove six screws from the top the cover).

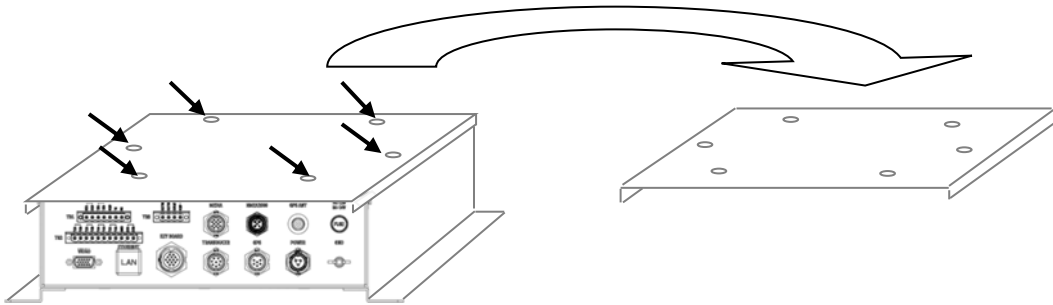

- 2 Set as follows according to the resolution of the monitor to be connected.

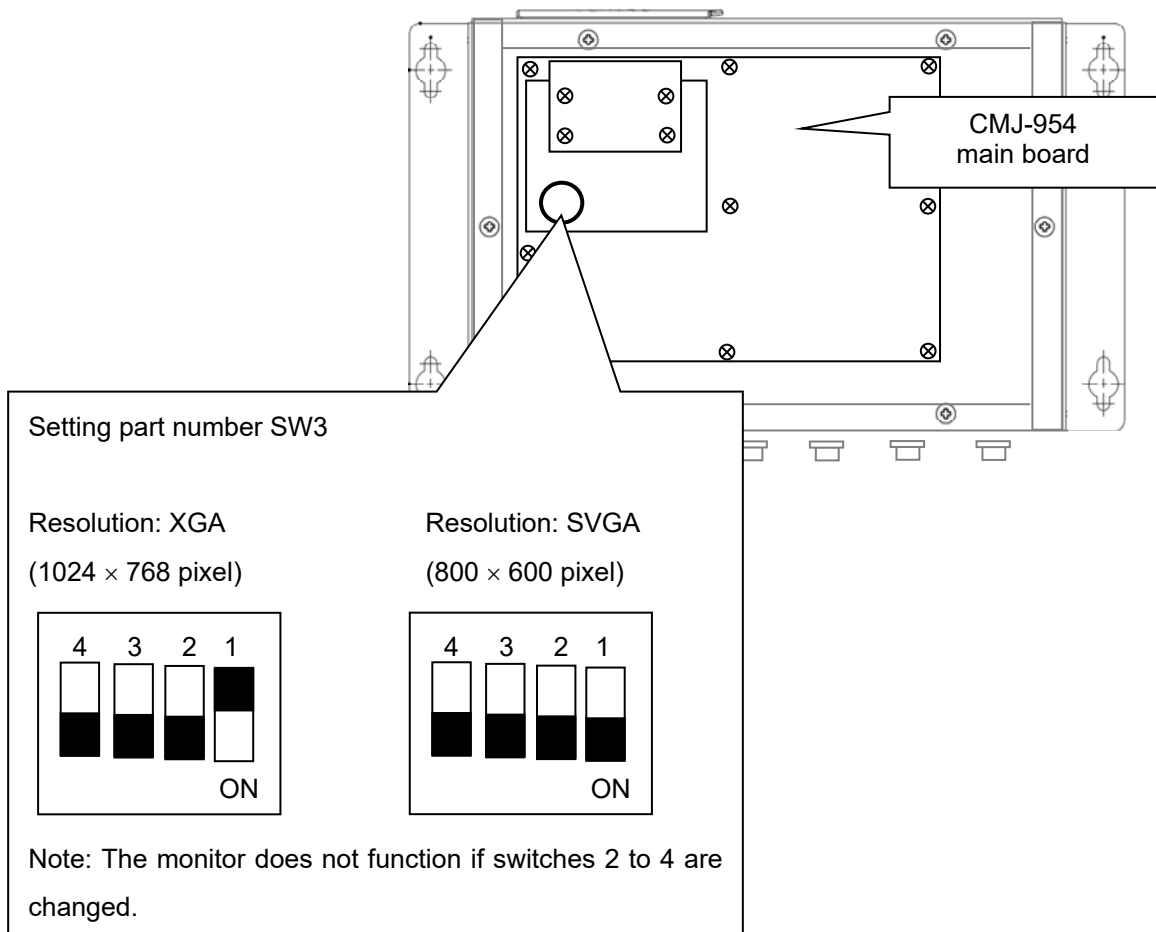

- 3 Fix the cover of the processing unit with screws.

Connecting a GPS receiver

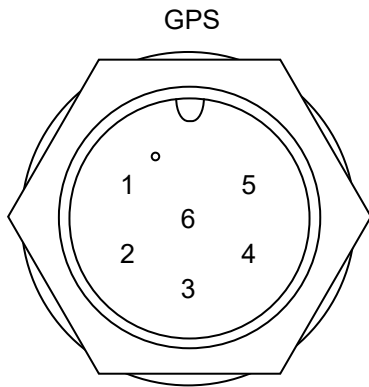

DGPS/GPS sensor: JLR-4341/4340 (optional)
 GPS connection cable: CFQ-9000 (optional)

Pin No.	Name		Description
1	+12V		Power supplied from the processing unit to the operation unit
2	GND		
3	Data COM	RXD-	Processing unit ← GPS receiver (return wire)
4	Data input	RXD+	Processing unit ← GPS receiver
5	Data output	TXD+	Processing unit → GPS receiver
6	Unused		

The input ports of this connector (pins 3 and 4) can be used as general-purpose input ports unless position information such as GPS is input.

See the item, "GPS", of Section 8.7 "Setting Communication – Communication Menu".

This equipment supports up to 3 ports (GPS/TB1/TB2) for serial input. When inputting four or more types of data, group them into one on the external equipment side.

For the input sentence, refer to "13.1 Functional specification : NMEA0183 input sentence".

Connecting external equipment

TB1

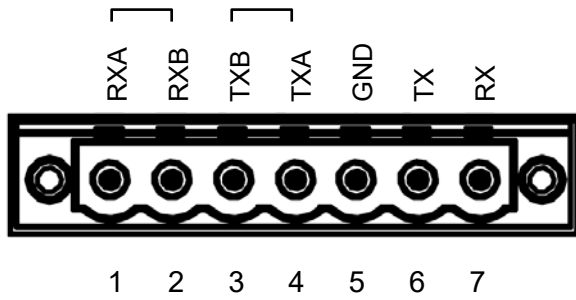

Pin No.	Name		Description
1	RS422 input	RXA	Inputs data. (The setting can be changed by selecting [System Configuration] - [Communication] - [NMEA0183-Port1].)
2		RXB	
3	RS422 output	TXB	Outputs data. (The setting can be changed by selecting [System Configuration] - [Communication] - [NMEA0183-Port1].)
4		TXA	
5	GND		
6	TX		Inputs/outputs RS232C (Parallel connection with RSR422 pins of numbers 1 to 4)
7	RX		

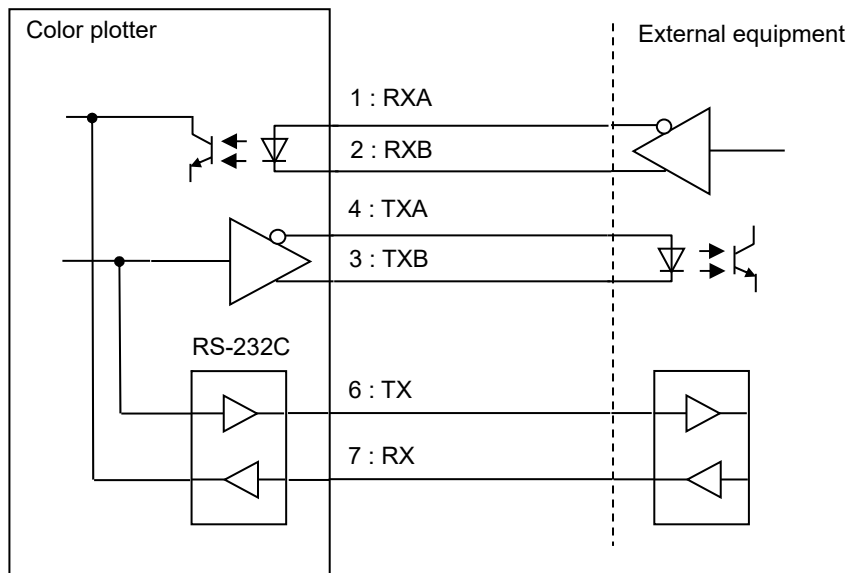

This equipment supports up to 3 ports (GPS/TB1/TB2) for serial input. When inputting four or more types of data, group them into one on the external equipment side.

For the input sentence, refer to "13.1 Functional specification : NMEA0183 input sentence".

TB2

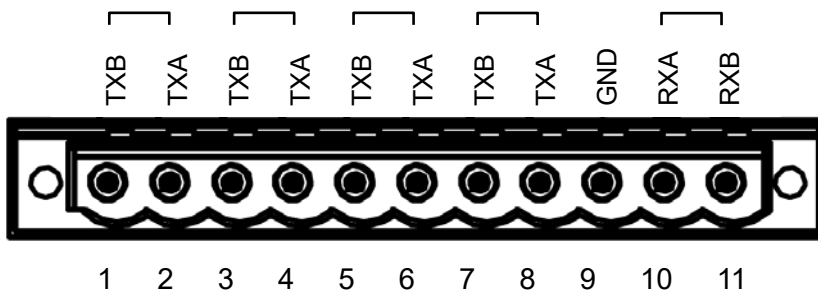

Pin No.	Name	Description
1	RS422 output TXB	Outputs 4 data items in parallel. (The setting can be changed by selecting [System Configuration] – [Communication] - [NMEA0183-Port2].)
2	TXA	
3	RS422 output TXB	
4	TXA	
5	RS422 output TXB	
6	TXA	
7	RS422 output TXB	
8	TXA	
9	GND	
10	RS422 input RXA	Inputs data. (The setting can be changed by selecting [System Configuration] – [Communication] - [NMEA0183-Port2].)
11	RXB	

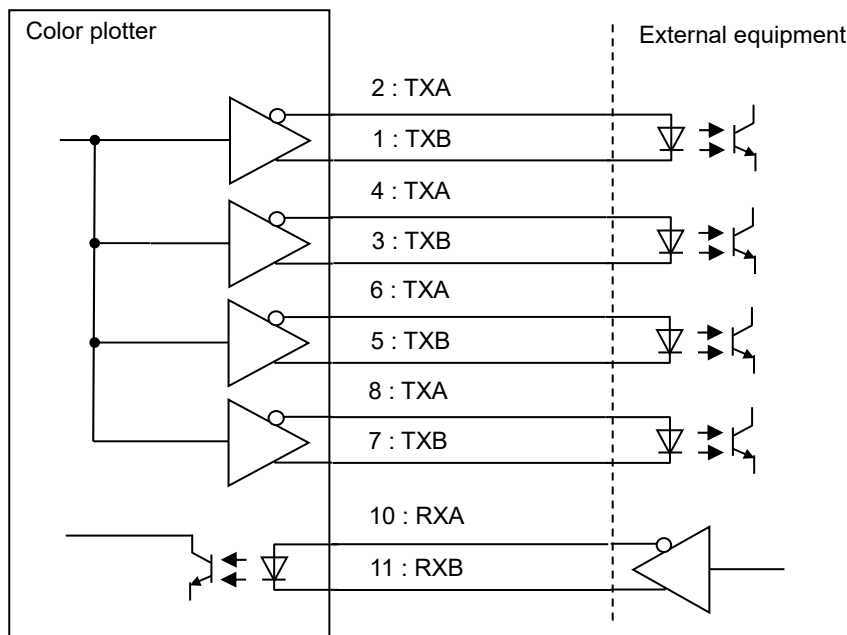

This equipment supports up to 3 ports (GPS/TB1/TB2) for serial input. When inputting four or more types of data, group them into one on the external equipment side.

For the input sentence, refer to "13.1 Functional specification : NMEA0183 input sentence".

Connecting an external event/external buzzer (log pulse)

TB3

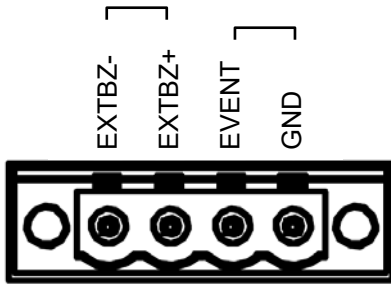

Pin No.	Name	Description
1	External buzzer pulse log	EXTBZ-
2		EXTBZ+
3	External event	EVENT
4		GND

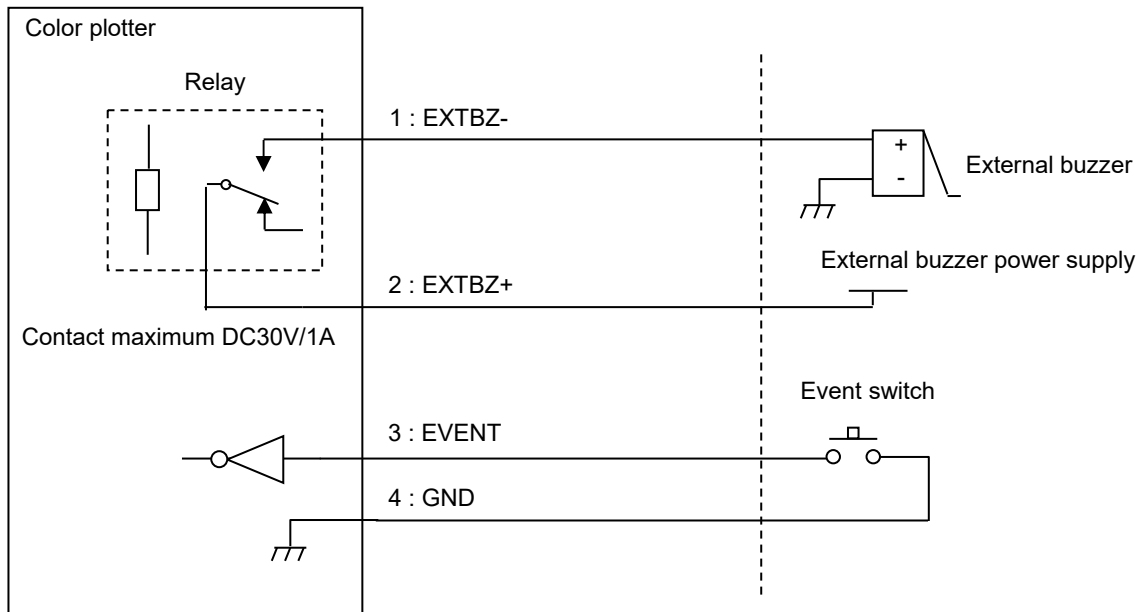

Terminal block (TB1, TB2, TB3) installation procedure

- 1** Press the button with a flathead screw driver.
- 2** Insert a cable in the cable insertion port.
- 3** Fix the connector (M2.5 screws: 2).

Cable specification

Conductor cross section	0.5 - 2.5 mm ²
Strip length	8 - 9 mm

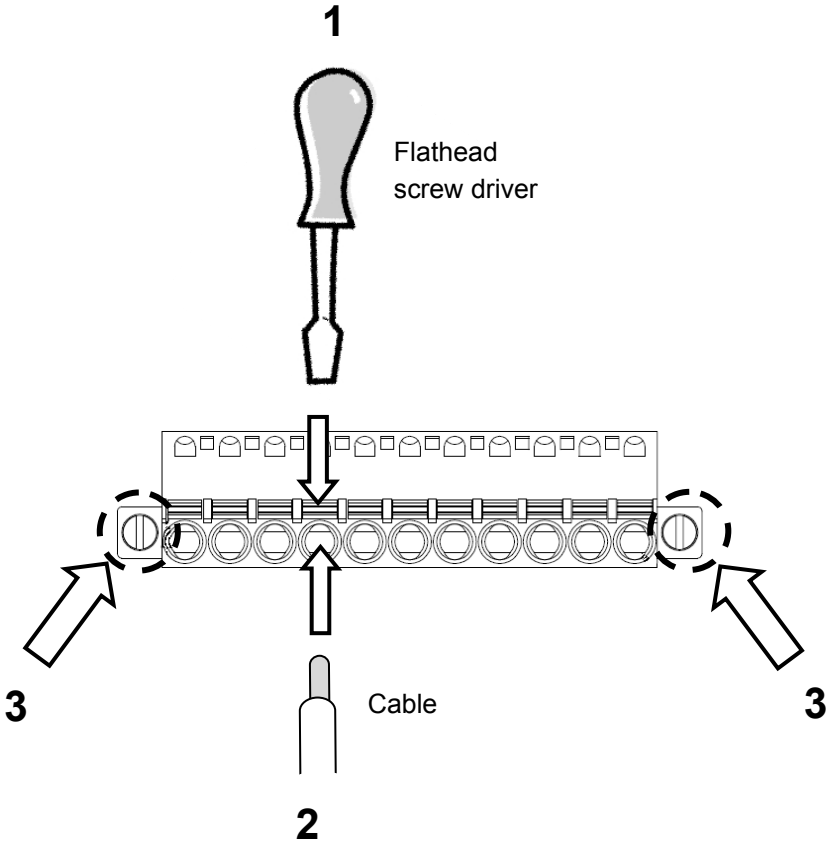

Connecting CCTV/S-VIDEO

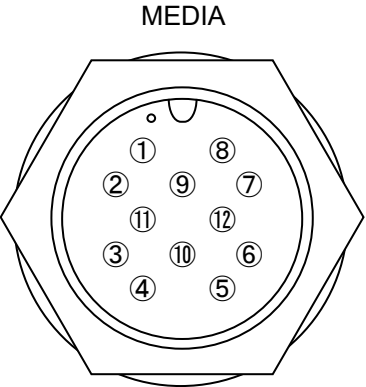

MEDIA cable: CFQ-7517 (optional)

Pin No.	Name	Description
1	+12V_GND	Connect a commercial cable by connecting a MEDIA cable.
2	AUDIO_GND	
3	AUDIO_IN_R	
4	AUDIO_OUT_L	
5	AUDIO_GND	
6	+12V *1	
7	VIDEO_GND	
8	VIDEO_GND	
9	VIDEO_IN1	
10	AUDIO_OUT_R	
11	AUDIO_IN_L	
12	VIDEO_IN2	

*1: Maximum current: 350mA

Appearance

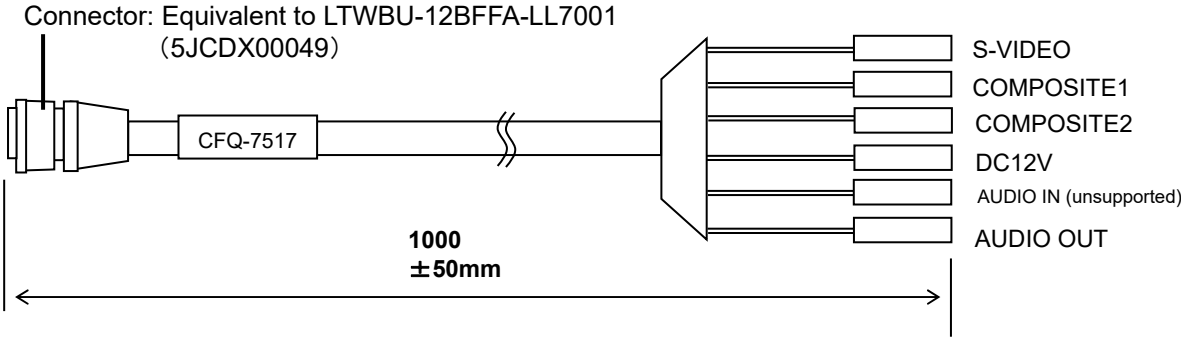

Connector diameter: φ20mm or less
 Cable diameter: φ40mm or less

Connecting NMEA2000

NMEA2000

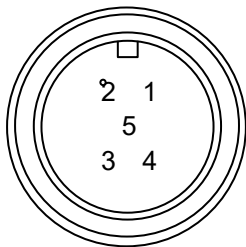

Micro type connector

Pin No.	Name		Description
1	GND		Outputs data with the specification that is set in "NMEA2000". (The setting can be changed by selecting [System Configuration] - [Communication] - [NMEA2000]).
2	Power V+	NET-S	
3	Power V-	NET-C	
4	CAN-H	NET-H	
5	CAN-L	NET-L	

Connecting a GPS antenna

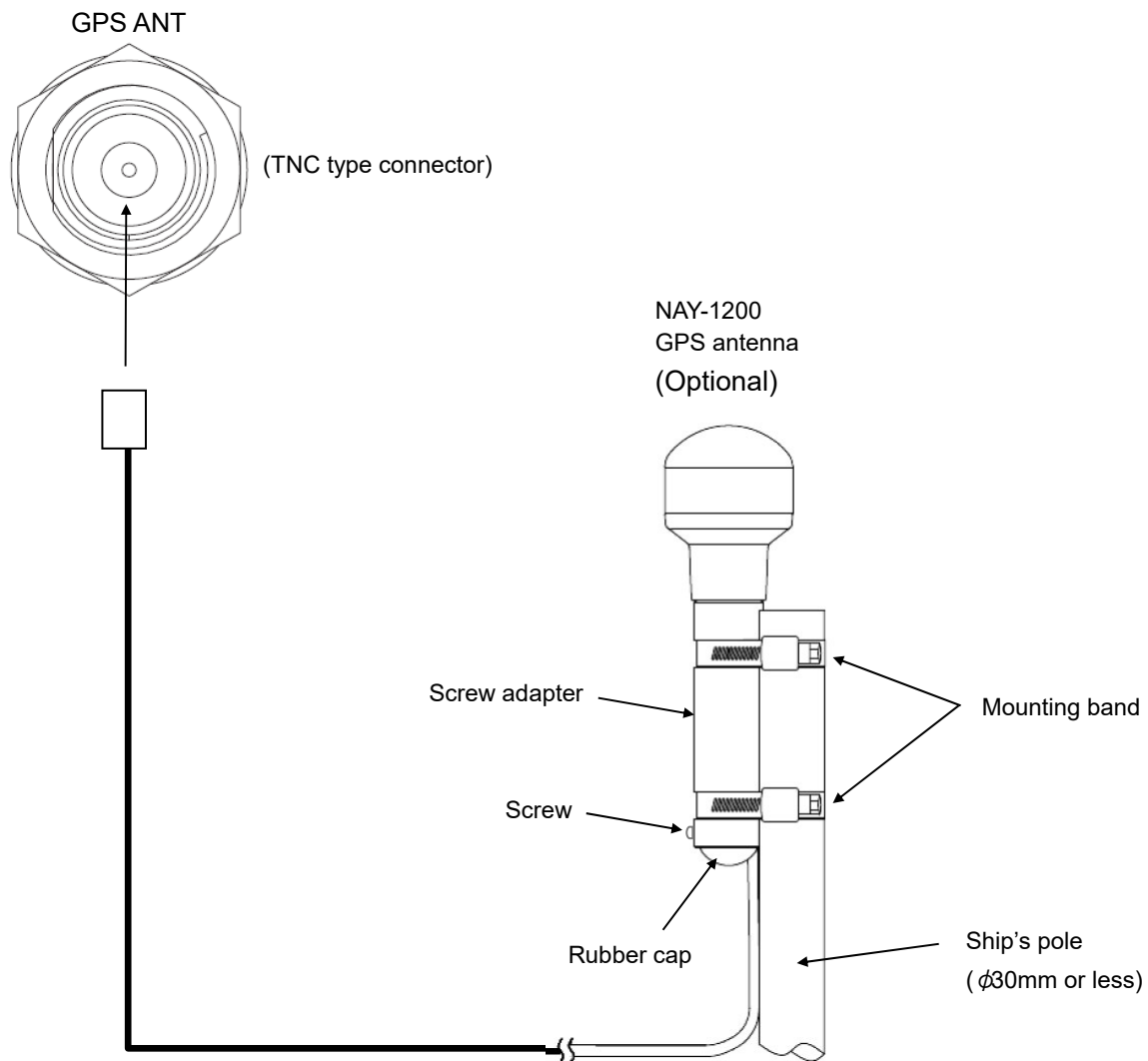

Attach the mounting band attached to NAY-1200 to pole diameter $\phi 30\text{mm}$ or less.

When disconnecting the cable from the GPS antenna, remove it in the following order.

- 1) Remove the screw.
- 2) Remove the rubber cap.
- 3) Remove screw adapter.

Connecting a transducer

TRANSDUCER

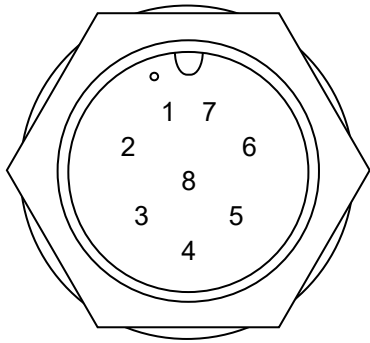

Transducer 600W : CFT-2505KZ (optional)

Transducer 1kW : CFT-2510KZ (optional)

Pin No.	Name	Description
1	TD+	Outputs a high voltage (+) to the transducer.
2	TEMP	Detects a water temperature (thermistor).
3	Unused	
4	TEMP	Detects a water temperature (thermistor).
5	TD-	Outputs a high voltage (-) to the transducer.
6	TD GND	GND of a high voltage of the transducer
7	Unused	
8	Unused	

Appearance

Connector: Equivalent to LTWBD-08BFFA-LL7001
(5JCDX00034)

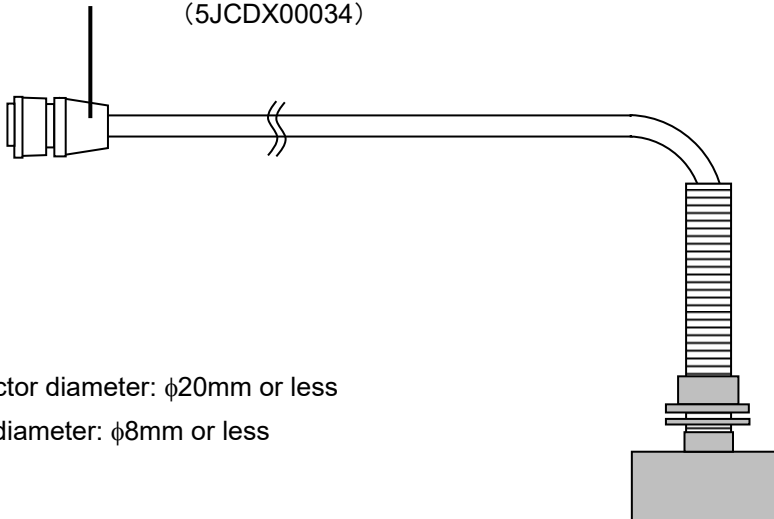

Connector diameter: $\phi 20$ mm or less

Cable diameter: $\phi 8$ mm or less

3.3 Connecting a card

Remove the rubber cover from SD/USB and insert a SD card or USB memory .

The SD card slot applies a push-in/push-out mode.

- When inserting a card, insert properly until a click sound is heard.
- When removing a card, press the card until a click sound is heard.

Do not insert any device in the USB slot other than USB memory (maximum current 350mA).

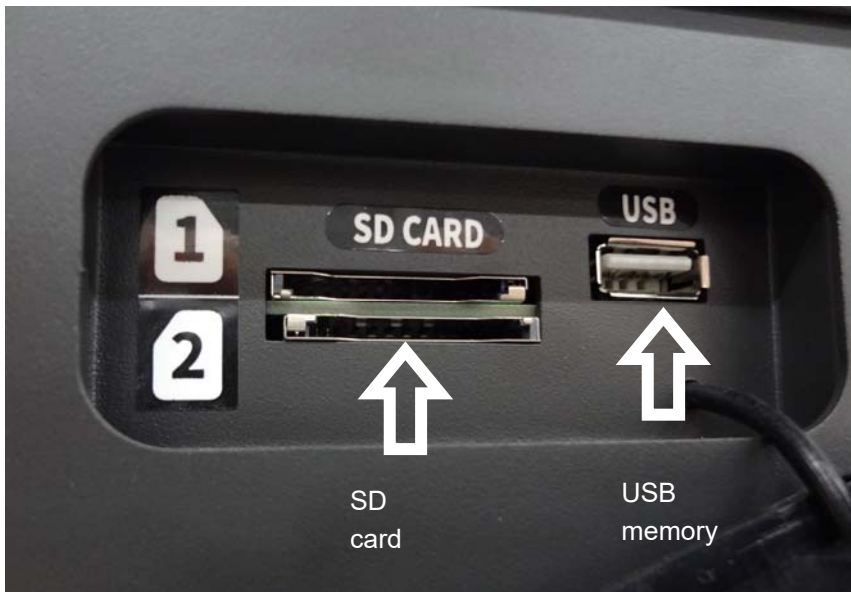

SD card specification

Standard	SDHC
Capacity	1GB - 32GB
File system	FAT16/FAT32 (FAT32 recommended)

USB memory specification

Type	USB type-A
Standard	USB 2.0
Capacity	1GB - 32GB
File system	FAT16/FAT32 (FAT32 recommended)

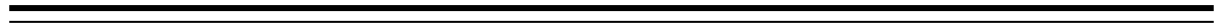

Section 4 Basic Operation

4.1 Turning on/off the power supply

4.1.1 Turning on the power supply

Use the following procedure to turn on the power supply.

- 1 Turn the [POWER] switch to the right side ([ON] side).

The power supply is turned on and the initial screen is displayed.

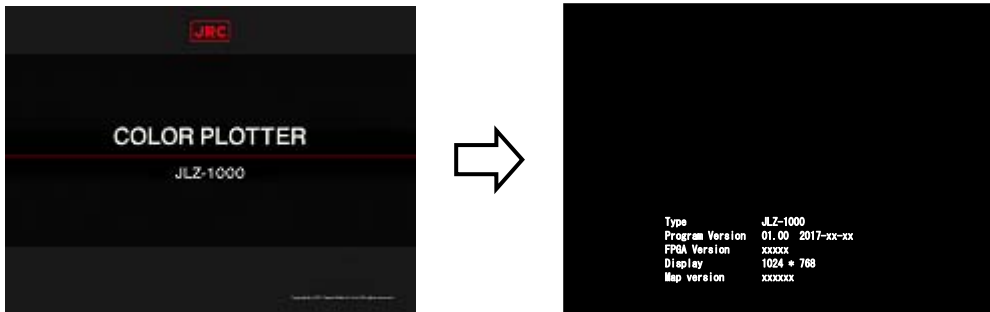

Then, the caution screen is displayed.

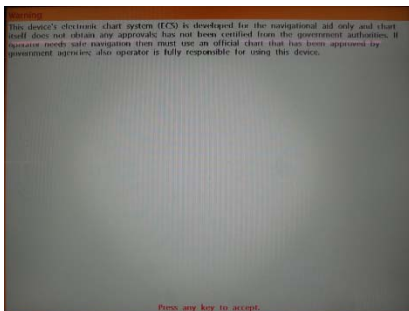

- 2 When message “Press any key to accept.” is displayed in blinking mode at the bottom of screen, press any key on the operation unit.

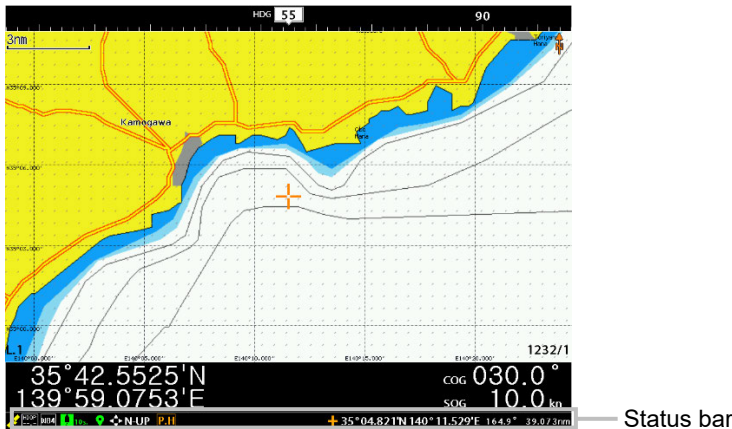

Display a GPS signal reception state

When this equipment starts, an icon that indicates the reception state of the signals from the GPS satellite is displayed at the left end of the status bar (see Section 4.2 “How to interpret the screen”).



Icon that shows the GPS signal reception state

The color of the icon that indicates the GPS positioning state changes as follows.

Color of the icon	GPS signal reception state
Red	This equipment is searching for signals from the GPS satellite or position information has not been input.
Yellow	The GPS positioning accuracy is low. When positioning is performed under DGPS, “D” is displayed at the top-left corner of the icon. 
Green	This equipment is positioning by receiving signals from the GPS satellite. When positioning is performed under DGPS, “D” is displayed at the top-left corner of the icon. 

4.1.2 Turning off the power supply

Use the following procedure for turning off the power supply.

1 Turn the [POWER] switch to the left side ([OFF] side).

The power supply is turned off several seconds after the message “Please wait ...” is displayed.

Note

If the power supply is turned off by any other method than turning the [POWER] switch of this equipment, tracks of the past 10 minutes and setting changes by the menu are not saved. Always use the [POWER] switch to turn off the power supply.

4.2 How to interpret the screen

The screen of this equipment comprises the following areas.

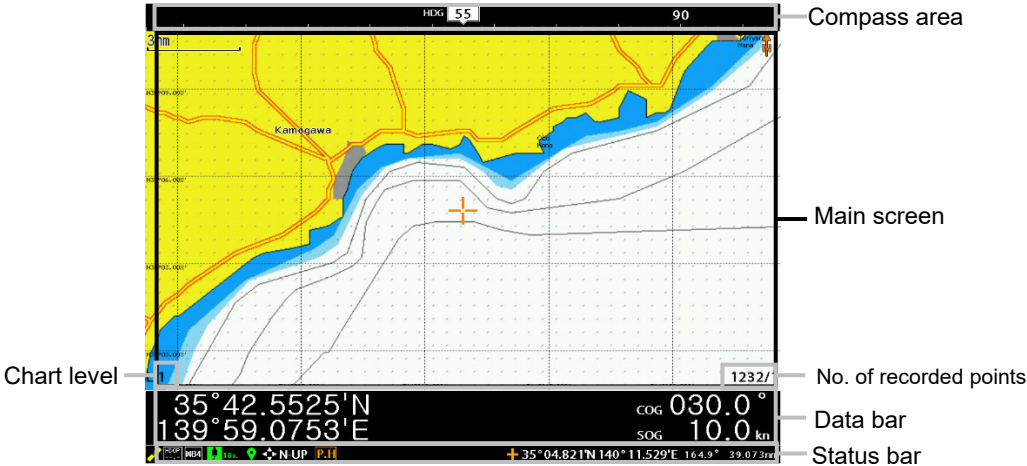

Each area is outlined below.

Area	Description
Compass area	<ul style="list-style-type: none"> The ship's heading (HDG)/course over the ground (COG) is displayed at the center. When both the ship's heading sensor and the course over the ground sensor input data, the value of the ship's heading is displayed. When the displayed value indicates the ship's heading, "HDG" is displayed and when the displayed value indicates the course over the ground, "COG" is displayed. The display of ship's heading (HDG) and the display of course over the ground (COG) can be inter-switched on "Data bar" on the function menu.
Main screen	<ul style="list-style-type: none"> A highway screen, a data screen, and a depth screen can be displayed in addition to a map screen. Multiple screens can be displayed by splitting the main screen into up to 4 screens.
Chart level	<ul style="list-style-type: none"> A chart level is displayed. Three chart levels are available (L.1/L.2/L.3).
No. of recorded points	<ul style="list-style-type: none"> Number of recorded points of tracks and marks (destinations) are displayed. The display format is as follows. "Number of track points recorded/number of mark points (destinations) recorded"
Data bar	<ul style="list-style-type: none"> Up to 12 types of information can be displayed in any position. Setting of display of only the latitude/longitude and traveling bearing is also possible.
Status bar	<p>The current status of the equipment is displayed. For the information that is displayed, see Section 4.2.4 "Details of a status bar".</p>

4.2.1 Switching the main screen

On the main screen, multiple screens comprising 2 to 4 screens can be displayed as well as a single screen such as a map screen or a depth screen only.

Some examples are provided below.

[Example 1: Splitting a screen into 2 segments, left and right]

- Displays a map screen on the left side and a depth screen on the right side.

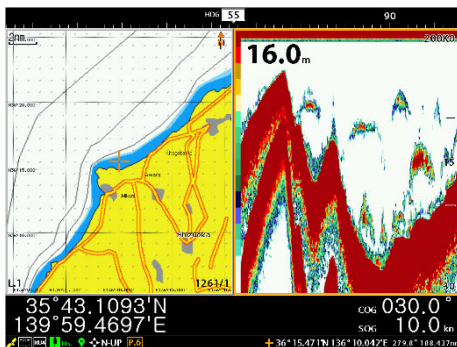

[Example 2: Splitting a screen into 3 segments]

- Displays a map screen on the left side, a depth screen on the top right side, and a data screen on the bottom right side.

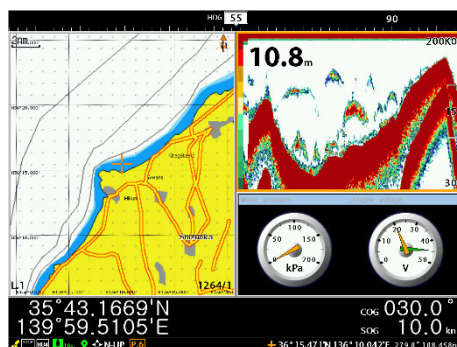

[Example 3: Splitting a screen into 4 segments]

- Displays a map screen on the top left side, a data screen on the bottom left side, a highway screen on the top right side, and a depth screen on the bottom right side.

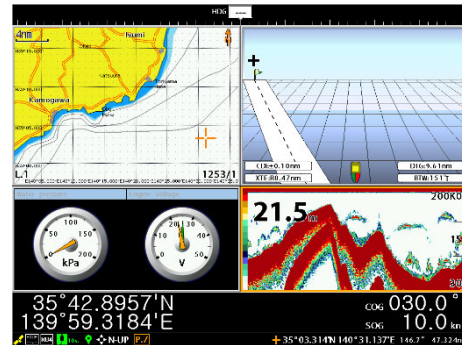

This equipment allows the setting of up to 10 display patterns.

4.2.1.1 Switching the main screen

Press the  (Screen) key.

Whenever the key is pressed, the pattern of the main screen changes.

Memo

For creating various screen patterns, see Section 6.1 “Customizing screens”.

4.2.2 Switching an active screen

At split screen display, the screen that is operated is called an active screen. The active screen is enclosed by an orange frame.

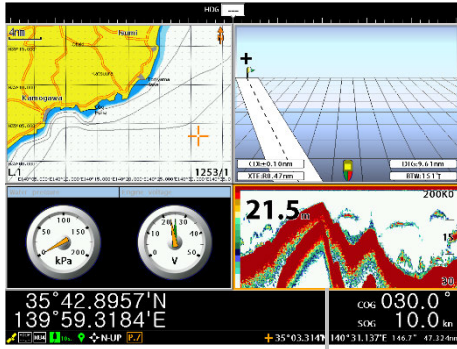

Orange frame that indicates an active screen

4.2.2.1 Switching an active screen

Press the (Active screen) key. Whenever the key is pressed, the active screen is switched.

4.2.3 Switching the Data bar pattern

The data bar consists of two display areas. The upper data bar (layout) displays is fixed. The lower data bar is switched from three patterns.

35°11.6530'N		COG 078.7°	
139°41.5567'E		SOG 17.4 kn	
35°11.6530'N	139°41.5567'E	SOG 17.4	kn COG 78.7
TMP 15.4	Depth 20.7	mTRP 611.33	nm TTL 611.33 nm

Upper row: Data bar (layout)

Lower row: Data bar

[type - 1]

Up to 12 types of information can be displayed. Any information can be set for display.

35°37.8173'N	139°55.7212'E	SOG 10.0	kn COG 30.0
---	Time	---	DIG --- nm TTL ---

[type - 2]

Up to 12 types of information different from [type – 1] can be displayed.

35°37.8701'N	139°55.7586'E	SOG 10.0	kn COG 30.0
TMP 15.0	Depth 14.0	mTRP 3239.66	nm TTL 3239.66 nm

[None]

The Data bar is hidden.

4.2.3.1 Switching a Data bar pattern

Press the (Data bar) key. Whenever this key is pressed, the pattern is switched.

[Type-1] -> [Type-2] -> [OFF]

Memo

The information that is displayed in the Data bar of [Type-1] and [Type-2] can be set/changed on the menu.

See Section 6.1.1.2 “Setting a data bar”.

4.2.4 Details of a status bar

The following information is displayed on the status bar.



[1] GPS positioning status

Displays the GPS positioning state in one of the following colors.

Red: The equipment is searching for signals from the GPS satellite.

Yellow: The GPS positioning accuracy is low.

Green: The equipment is positioning by receiving signals from the GPS satellite.

[2] HDOP

Displays the GPS positioning accuracy with a numeric value.

The higher the accuracy is, the lower the value becomes.

[3] Geodetic system

Displays the geodetic system that is currently selected.

For WGS84, “W84” is displayed, for WGS72, “W72” is displayed, and for any other systems, the number such as “002” is displayed.

[4] Track color and display interval



The icon is displayed with the color of the track that is currently set.

The recording interval of the track that is currently set is also displayed. The track recording interval can be set with time (1s./2s./5s./10s./20s./30s./1m./2m./5m./10m./20m./30m./60m.) or distance (0.01/0.02/0.05/0.1/0.2/0.5/1.0/2.0/ 5.0/10.0nm).

[5] Mark color

The icon is displayed with the color of the mark that is currently set.

[6] Own ship's position icon

When the own ship's position is displayed at the center of the map,  is displayed and in other cases,  is displayed.

[7] Bearing mode

Displays the current bearing mode.

The following bearing modes can be selected depending on the motion mode.

Motion mode	Bearing mode
True motion	N-UP, S-UP, W-UP, and E-UP
Relative mode	N-UP, C-UP, H-UP, and WP-UP

[8] Main screen number

Displays the number of the main screen that is currently displayed (P.H, P.1 to P.9).

[9] Latitude and logitude/bearing/distance

Displays the latitude and longitude of the cursor position and the bearing and distance from own ship to the cursor position.

4.3 Switching a screen brightness

A screen brightness of the equipment can be switched between a day screen and a night screen. To switch the screen brightness, press the  (Day/Night) key.

Whenever the key is pressed, the mode switches between the day mode and the night mode.

4.4 Changing the setting on the menu

This equipment has the System Configuration menu that is used for setting various equipment modes and status at power-on, a function menu for setting specific to each screen, and a page menu for customizing screen display and editing marks and routes .











Name of the function menu of each screen

The menu that is displayed when the map screen is activated is called a “map screen menu”.

The menu that is displayed when the depth screen is activated is called a “depth screen menu”.

4.4.1 Displaying a menu

See below for the procedure for displaying each menu.

Menu	Display procedure	Menu displayed
System Configuration menu	Hold down the  (Menu) key. When the key is pressed again or the  key is pressed, the System Configuration menu is cleared.	
Function menu	Activate the screen whose menu is to be displayed and press the  (Menu) key. When the key is pressed again or the  key is pressed, the function menu is cleared. <ul style="list-style-type: none"> • When a single screen is displayed, the screen is active. • When multiple screens are displayed, switch the active screen by pressing the  (Active screen) key. • Some screens may not have a function menu. 	
Page menu	Two page menus are available. Hold down the  (Active screen) key or the  (Screen) key. If the key is pressed again or the  key is pressed, the page menu is cleared.	







4.4.2 Operating the System Configuration menu/function menu

4.4.2.1 Menu levels

When the ► mark is attached on the right side of the menu item that is displayed, there is a following level.

4.4.2.2 Keys that are used for menu operations

Use the following keys when setting by menu operations.

Key	Function
 (Up/Down key)	Select an item at the current level. The selected item is displayed in reverse video.
 (Center),  (Right), or  key	<ul style="list-style-type: none"> • When the next level is available, the function proceeds with the next level. • When no next level is available, the values or contents that can be set for the items are displayed. • When the value or content that can be set is selected by using the  (Up/Down) key and the key is pressed, the value or the content is selected. • If a value or content is selected and the key is pressed, the value or the content is determined. • To enable/disable the item, press the item. Whenever the item is pressed, a check mark is attached (<input checked="" type="checkbox"/>) or removed (<input type="checkbox"/>)
 (Left) or  key	<ul style="list-style-type: none"> • When this key is pressed, the level returns to the previous level. • When this key is pressed while the value or content that can be set is displayed, the item is returned to the previous state without changing the value or the content. • If the key is pressed after switching the item to Enable/Disable, the item is returned to the previous state by maintaining the setting performed after switching.



4.4.2.3 Example of menu operations

This section shows the procedure for setting to add water temperature display by using the System Configuration menu.

- 1 Hold down the  (Menu) key.

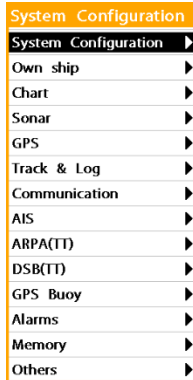
The System Configuration menu is displayed.



- 2 Select [Track & Log] by using the   (Up/Down) key (the item is displayed in reverse video).



- 3 Press the  (Center),  (Right), or  key.



Proceed with the next level.

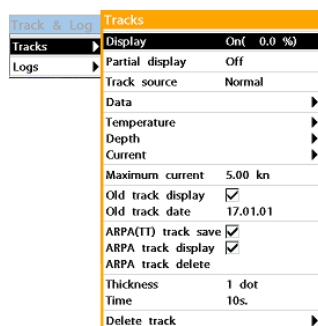

- 4 Press the  (Center),  (Right), or  key.

Proceed with the next level.



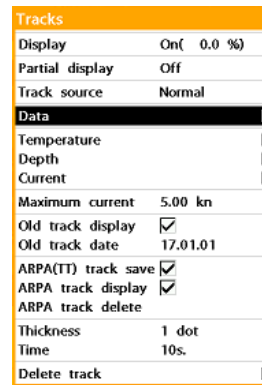

- 5 Select [Data] by using the   (Up/Down) key (displayed in reverse video).

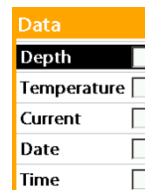

- 6 Press the  (Center),  (Right), or  key.

A screen for setting to enable/disable the data to be added to the track is displayed.



- 7 By using the   (Up/Down) key, select [Temperature] (displayed in reverse video).

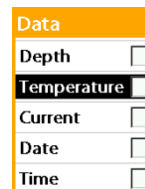

- 8 Press the  (Center),  (Right), or  key.

A check mark is attached to [Temperature] (enabled).



- 9 Press the  (Left) or  key.

Press the key repeatedly until the menu is cleared.

Section 5 Map Screen Operation Procedure

This Section describes the main procedure of the map screen.

Example: The unit of the distance is nm and the length of the scale bar is 10nm.



5.1 Map card and screen display

In this equipment, map cards of new pec and Navionics can be used.

Two maps can be inserted in to the SD lot.

When a card of new pec and a card of Navionics are inserted, the map to be displayed can be selected.

Memo

For the map selection (switching) procedure, see Section "5.10 Switching a map".

- 1 Press the  (Zoom In) key or the  (Zoom Out) key.

The map is zoomed in or zoomed out.

When the  (Zoom In)/ (Zoom Out) key is held down, the map is zoomed in/zoomed out continuously.

5.2.2 Presetting scale values

By presetting 10 scale values in advance, 10 scale values are made available for switching by pressing the  (Preset scale) key.

Memo



At the factory delivery, 0.01nm, 0.05nm, 0.1n, 0.2nm, 0.5nm, 1.0nm, 2.0nm, 3.0nm, 5.0nm, and 10.0nm are preset as the lengths of the scale bar.

When using a new pec card, the following items are also to be noted.

- When new pec is displayed on the two screens, the same operation mode is applied.
- A variety of geodetic positioning systems are available for selection.

5.2 Basic map operation procedure

5.2.1 Zooming in/zooming out a map

To switch the scale of the map, use the  (Zoom In)/ (Zoom Out) key.

In this equipment, the scale bar and the length are displayed at the top left corner of the map screen. The scale is displayed in the range of 0.01 to 300 nm in the scale bar.

5.2.2.1 Presetting scale values

- 1 Hold down the  (Preset scale) key.





A screen for setting 10 scale values (length of the scale bar) is displayed.

Preset scale	
Preset scale	1 0.01
Preset scale	2 0.05
Preset scale	3 0.1
Preset scale	4 0.2
Preset scale	5 0.5
Preset scale	6 1.0
Preset scale	7 2.0
Preset scale	8 3.0
Preset scale	9 5.0
Preset scale	10 10.0

- 2 Select a preset number whose scale value is to be changed.
Select one of the values from Preset scale 1 to Preset scale 10.

- 3 Press the  (Center),  (Right) or  key.

Preset scale	
Preset scale 1	0.01
Preset scale 2	Off
Preset scale 3	0.01
Preset scale 4	0.05
Preset scale 5	0.1
Preset scale 6	0.2
Preset scale 7	0.5
Preset scale 8	1.0
Preset scale 9	2.0
Preset scale 10	3.0
	5.0
	10.0
	20.0
	50.0
	100.0
	200.0
	300.0

- 4 Select a new scale and confirm the selection by pressing the  (Center),  (Right), or  key.
- 5 End the operation by pressing the  (Left) or  key.

Memo

When the scale value is set to [Off], the preset value becomes invalid.
For instance, by setting Preset scale 6 to Preset scale 10 to [Off] and setting Preset scale 1 to Preset scale 5 to any scale values, the scale can be changed to five levels.

5.2.2.2 Switching a scale to a preset scale

Whenever the  (Preset scale) key is pressed, the preset scale is switched sequentially.

5.2.3 Moving a map

5.2.3.1 Moving a map by using the



(Up/Down/Left/Right) keys

When any of the  (Up/Down/Left/Right) keys are pressed, the map moves in the direction opposite to the key. When the key is pressed continuously, the map moves continuously.

Memo

By using the System Configuration menu, it is possible to set so that the map moves in the direction of the key.

See the “Arrow key” item in Section 8.1 “Setting operation general - System Configuration menu”.

Depending on the map to display (new pec or Navionics), the amount of movement of the screen scroll is different.

new pec: The amount of movement increases gradually.

Navionics: The amount of movement is constant and moves.

5.2.3.2 Moving a map by using the trackball

Use the trackball to move the cursor.
When the trackball is operated continuously after the cursor has moved to the top/bottom/left/right edge of the map screen, the map moves to display the hidden section.

5.2.4 Changing the contents that are displayed on a map

In this equipment, three levels (chart levels) can be set for the contents of the information that are displayed on the map.

The current chart level (L1 to L3) is displayed at the bottom left corner of the map screen.

5.2.4.1 Setting a chart level

Memo

When the map is new pec, three chart levels are set as follows at the factory delivery..

○:Display ×:Undisplay

Information	Chart level		
	1	2	3
Lat/Lon grid	○	×	×
Depth Digit	○	×	×
Lighthouse	○	○	×
Buoy	○	○	×
Wreck Ship	○	×	×
Fish Haven	○	○	×
Sea Lane	○	○	×
Restricted Area	○	○	×
Fishing Area	○	×	×
Sea Cable	○	×	×
Name	○	○	×
Mark Attribute	○	○	×

When the map is Navionic, three chart levels are set as follows at the factory delivery.

○:Display ×: Undisplay

Information	Chart level		
	1	2	3
Lat/Lon grid	○	×	×
Easy view	×	×	×
Community layer	○	○	×
Nav-aids	×	×	×
Light Sector	○	×	×
Full text	○	×	×
Boundaries	×	×	×
Shading	○	○	×
Symbol type	INT (Constantly ON)		
Aerial photo coverage	Land (Constantly ON)		

- 1 Hold down the  (Menu) key.
The System Configuration menu is displayed.

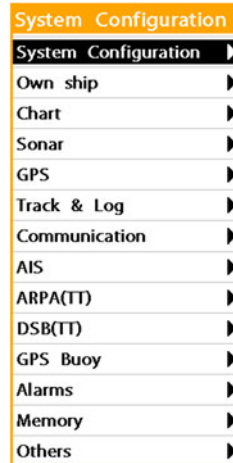

- 2 Select [Chart] and confirm the selection by pressing the  (Center),  (Right), or  key.

The [Chart] menu is displayed (the map is Navionics in the following example).

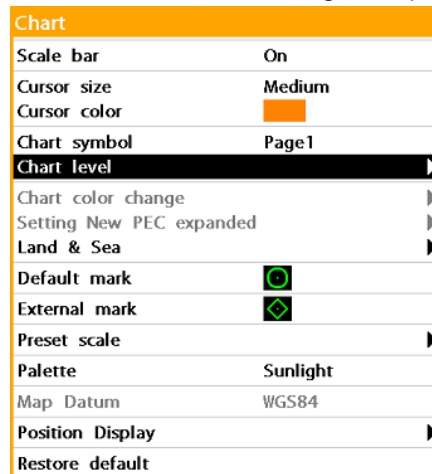

- 3 Select [Chart level] and confirm the selection by pressing the  (Center),  (Right), or  key.

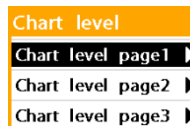

- 4 Select the chart level whose setting is to be changed and press the  (Center),  (Right), or  key.

Select one of levels from Chart lever page1 to Chart lever page3.



Chart level page2	
Lat/Lon grid	<input type="checkbox"/>
Depth Digit	<input type="checkbox"/>
Lighthouse	<input checked="" type="checkbox"/>
Buoy	<input checked="" type="checkbox"/>
Wreck Ship	<input type="checkbox"/>
Fish Haven	<input checked="" type="checkbox"/>
Sea Lane	<input checked="" type="checkbox"/>
Restricted Area	<input checked="" type="checkbox"/>
Fishing Area	<input type="checkbox"/>
Sea Cable	<input type="checkbox"/>
Name	<input checked="" type="checkbox"/>
Mark Attribute	<input checked="" type="checkbox"/>



new pec



Chart level page2	
Lat/Lon grid	<input type="checkbox"/>
Easy view	<input type="checkbox"/>
Community layer	<input checked="" type="checkbox"/>
Nav-aids	<input type="checkbox"/>
Light Sector	<input type="checkbox"/>
Full text	<input type="checkbox"/>
Boundaries	<input type="checkbox"/>
Shading	<input checked="" type="checkbox"/>
Symbol type	INT
Aerial photo coverage Land	

Navionics

- 5 Enable the information to be displayed (attach a check mark).

Whenever information is selected and the  (Center),  (Right), or  key is pressed, the setting is switched to On/Off.

- 6 End the setting of the chart level that was selected in Step 4 by pressing the  (Left) or  key.

Close the menu by setting another chart level or by repeatedly pressing the  (Left) or  key.

5.2.4.2 Switching a chart level



- 1 Hold down the  (Menu) key.

The System Configuration menu is displayed.

System Configuration	
System Configuration	▶
Own ship	▶
Chart	▶
Sonar	▶
GPS	▶
Track & Log	▶
Communication	▶
AIS	▶
ARPA(TT)	▶
DSB(TT)	▶
GPS Buoy	▶
Alarms	▶
Memory	▶
Others	▶

- 2 Select [Chart] and confirm the selection by pressing the  (Center),  (Right), or  key.



The [Chart] menu is displayed (In the following example, the map is Navionics).

Chart	
Scale bar	On
Cursor size	Medium
Cursor color	
Chart symbol	Page1
Chart level	▶
Chart color change	▶
Setting New PEC expanded	▶
Land & Sea	▶
Default mark	
External mark	
Preset scale	▶
Palette	Sunlight
Map Datum	WGS84
Position Display	▶
Restore default	

- 3 Select [Chart symbol] and confirm the selection by pressing the  (Center),  (Right), or  key.

A screen for selecting a chart level is displayed.

Page1
Page2
Page3

4 Select a required chart level (one of page 1 to page 3) and confirm the selection by pressing the  (Center),  (Right), or  key.

5 End the setting by repeatedly pressing the  (Left) or  key.

The contents that are displayed on the map are switched to those of the chart level that is selected in Step 4.

Memo

The chart level switching function can be registered in a numeric key (F1 to F10 key). For the details, see Section 9 “Setting and Executing Shortcut Keys”.

5.2.5 Switching a bearing mode

5.2.5.1 Motion mode and bearing mode

Any of the following modes can be selected in this equipment according to the motion mode.

When the motion mode is [True motion]:

N-UP (North UP): Displays the map by placing North at the top.

S-UP (South UP): Displays the map by placing South at the top.

W-UP (West UP): Displays the map by placing West at the top.

E-UP (East UP): Displays the map by placing East at the top.

When the motion mode is [Relative mode]

N-UP (North UP): Displays the map by placing North at the top.

C-UP (Course UP): Displays the map by placing the direction of the course of own ship at the top.

H-UP (Head UP): Displays the map by placing the heading position of own ship at the top.

WP-UP (Way Point UP): Displays the map by placing the waypoint direction at the top.

Memo

The motion mode is set to [True motion] at the factory delivery.

For switching of a motion mode, see the “Motion mode” item in Section 8.2 “Setting display of own ship – Own ship menu”.

5.2.5.2 Switching a bearing mode

1 Hold down the  (Center) key.





By holding down the key, the bearing mode can be switched.



5.2.6 Displaying a map by placing own ship at the center



1 Press the  (Center) key.

The map is displayed by placing own ship at the center.

5.2.7 Displaying a map by placing the cursor position at the center

Move own ship from the center of the screen by using the     (Up/Down/Left/Right) keys or the trackball.



In this case,  on the status bar is switched to .

If the map is zoomed in/zoomed out by using the  (Zoom In)/ (Zoom Out) key in this state, the cursor position is displayed at the center of the screen.

5.3 Using parallel index cursor / circular cursor

In this system, two measuring tools can be used for measuring distance and bearing, a parallel index cursor and a circular cursor. A combination of the two cursors is referred to as a variable cursor.

5.3.1 Displaying a variable cursor

- 1 To display a variable cursor by placing the own ship's position at the center, press the  (Variable cursor) key. To display a variable cursor based on the cross-hairs cursor position, hold down the  (Variable cursor) key.



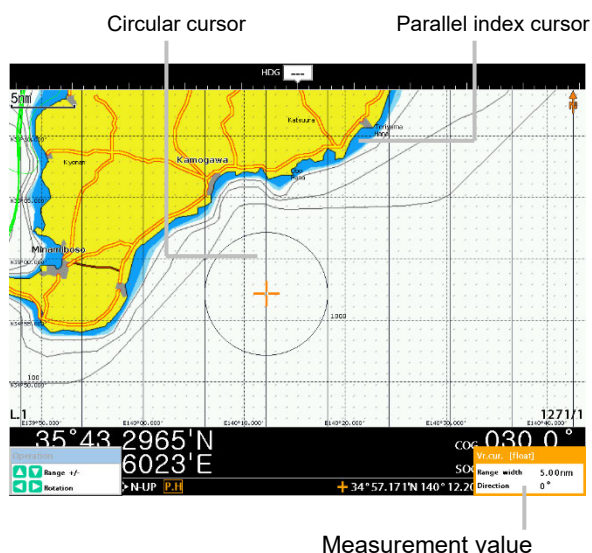

A parallel index cursor and a circular cursor are displayed and at the same time, the measurement values are displayed at the bottom right corner of the screen.







- The diameter of the circular cursor is equal to the width of the parallel index cursor.
- By operating a variable cursor, the distance and bearing from the own ship's position or the cross-hairs cursor position to the target can be measured.

5.3.1.1 Operating a variable cursor

Changing the width of the measurement range (interval of the parallel index cursor and the diameter of the circular cursor)

Use the   (Up and Down) keys. To increase the width, press the  key and to reduce the width, press the  (Down) key. As a result, the [Range width] value at the bottom right corner of the screen changes.

Rotating the parallel index cursor

Use the   (Left and Right) keys. To rotate the cursor anticlockwise, press the  (Left) key and to rotate the cursor clockwise, press the  (Right) key. The cursor rotates in the unit of 1°. As a result, the [Direction] value at the bottom right corner of the screen changes.

5.3.1.2 Ending a measuring mode

To end a measuring mode by clearing the measurement value display, press the  key. The variable cursor on the map remains.

5.3.1.3 Clearing a variable cursor

Press (or hold down) the  (Variable cursor) key.

5.4 Selecting a color of a mark/track

5.4.1 Selecting a color of a mark

In this equipment, any mark can be registered on a map.

Any meaning can be assigned to the mark and a mark can also be used as the destination for setting a route.

Any of seven colors or Off can be set for a mark.

When the mark is set to Off, the mark cannot be registered by holding down the  (Mark) key.

- 1 Press the  (Mark) key and select a mark color on the status bar .**

The background color is set to the color of the current mark.



- 2 Select a required color by turning the [Color] switch.**

When the switch is turned fully to the right side, the function is set to Off.

5.4.2 Selecting a track color

Any of seven colors or Off can be set for a track.

When the track is set to Off, the mark track is not registered.

Memo

When [Track Source] in the [Tracks] menu (in the System Configuration menu) is set to [Normal], the track color can be selected by using the procedure indicated below. At the factory delivery, it is set to [Normal].

- 1 Select a track color of the status bar by pressing the  (Track) key.**

The background color is set to the current track color.



- 2 Turn the [Color] switch and select a required color.**

When the switch is turned fully to the right side, the function is set to Off.

5.5 Setting the details of Track & Log display

Details can be set for a track such as the interval for placing dots that comprise the track and information to be displayed by adding to the track.

Example: Track with water depth and water temperature added

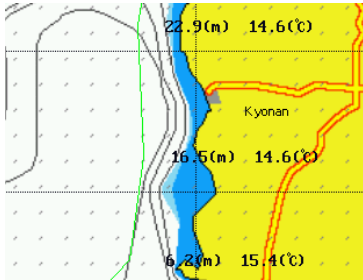

5.5.1 Displaying the [Tracks] menu

- 1 Hold down the  (Track) key.

The [Tracks] menu is displayed.

Tracks	
Display	On(0.0 %)
Partial display	Off
Track source	Normal
Data	▶
Temperature	▶
Depth	▶
Current	▶
Maximum current	5.00 kn
Old track display	<input checked="" type="checkbox"/>
Old track date	17.01.01
ARPA(TT) track save	<input checked="" type="checkbox"/>
ARPA track display	<input checked="" type="checkbox"/>
ARPA track delete	
Thickness	1 dot
Time	10s.
Delete track	▶



To close the [Tracks] menu, press the  key.

The [Tracks] menu can be displayed by using the following procedure also.

- 1 Hold down the  (Menu) key.

The System Configuration menu is displayed.

System Configuration	
System Configuration	▶
Own ship	▶
Chart	▶
Sonar	▶
GPS	▶
Track & Log	▶
Communication	▶
AIS	▶
ARPA(TT)	▶
DSB(TT)	▶
GPS Buoy	▶
Alarms	▶
Memory	▶
Others	▶



- 2 Select [Track & Log] by using the   (Up/Down) keys (displayed in reverse video).

GPS	▶
Track & Log	▶
Communication	▶

- 3 Press the  (Center), , or  key.

The system advances to the next level.

Track & Log	▶	Track & Log
Communication	▶	Tracks
AIS	▶	Logs

- 4 Check that [Tracks] is selected and Press the  (Center), , or  key.







The [Tracks] menu is displayed.







5.5.2 Displaying track details













Select an item to be set in the [Tracks] menu and set as required.







The following table shows the setting contents and setting value of each item in the [Tracks] menu.

Item		Setting contents	Setting value (Underline: Default value)
Display		Set whether the track is displayed on the map screen.	Off <u>On</u>
Partial display		When set track off with the [Color] switch, set whether to display the most recent track.	<u>Off</u> 5/10/20/30/50/100 dot
Track source		Select whether the track color is be changed according to manual mode, water depth, or water temperature. Normal: Change the track color by the [Color] switch. Depth: Change to the color that is allocated to the water depth range that is set in [Depth] according to the current water depth. Temperature: Change to the color that is allocated to the water temperature range that is set in [Temperature] according to the current water depth.	<u>Normal</u> Depth Temperature
Data	Depth	Set whether water depth data is to be added to the track. When a check mark is attached, the item is enabled and when the check mark is removed, the item is disabled.	Enable <u>Disable</u>
	Temperature	Set whether water temperature data is to be added to the track. When a check mark is attached, the item is enabled and when the check mark is removed, the item is disabled.	Enable <u>Disable</u>
	Current	Set whether a current vector is to be added to the track. When a check mark is attached, the item is enabled and when the check mark is removed, the item is disabled.	Enable <u>Disable</u>
	Date	Set whether a date is to be added to the track. When a check mark is attached, the item is enabled and when the check mark is removed, the item is disabled.	Enable <u>Disable</u>

Item		Setting contents	Setting value (Underline: Default value)
	Time	<p>Set whether a time is to be added to the track.</p> <p>When a check mark is attached, the item is enabled and when the check mark is removed, the item is disabled.</p>	<p>Enable</p> <p><u>Disable</u></p>
Temperature	Temperature1 Temperature2 Temperature3 Temperature4 Temperature5 Temperature6 Temperature7	<p>Set a temperature within the range from Temperature1 to Temperature7.</p> <p>The temperature range that can be set from Temperature1 to Temperature7 is from 0.0°C to 40.0°C in 0.1°C units. This range is divided into 7, creating Temperature1 to Temperature7.</p> <p><u>Setting a temperature range</u></p> <p>Select a digit to be set by using   (Left/Right) keys and select a value by using the   (Up/Down) keys. After changing the value, determine the setting by pressing the  (Center) or  key.</p> <p>The color that is displayed on the setting screen is assigned to each water temperature range.</p>	<p>Temperature1: 0.0°C to (Minimum temperature of Temperature2 – 0.1°C)</p> <p>Temperature2: (Maximum temperature of Temperature1 + 0.1°C) to (Minimum temperature of Temperature3 – 0.1°C)</p> <p>Temperature3: (Maximum temperature of Temperature2 + 0.1°C) to (Minimum temperature of Temperature4 – 0.1°C)</p> <p>Temperature4: (Maximum temperature of Temperature3 + 0.1°C) to (Minimum temperature of Temperature5 – 0.1°C)</p> <p>Temperature5: (Maximum temperature of Temperature4 + 0.1°C) to (Minimum temperature of Temperature6 – 0.1°C)</p> <p>Temperature6: (Maximum temperature of Temperature5 + 0.1°C) to (Minimum temperature of Temperature7 – 0.1°C)</p> <p>Temperature7: (Maximum temperature of Temperature6 + 0.1°C) to 40.0°C</p>

Item		Setting contents	Setting value (Underline: Default value)
Depth	Depth1 Depth2 Depth3 Depth4 Depth5 Depth6 Depth7	<p>Set a depth range from Depth1 to Depth7.</p> <p>The depth range that can be set from Depth1 to Depth7 is from 10m to 999m in 1m units. This range is divided into 7, creating Depth1 to Depth7.</p> <p><u>Setting a water depth range</u></p> <p>Select a digit to be set by using   (Left/Right) keys and select a value by using the   (Up/Down) keys. After changing the value, determine the setting by pressing the  (Center) or  key.</p> <p>The color that is displayed in the setting screen is assigned to each water depth range.</p>	<p>Depth1: 10m to (Minimum depth of Depth2 – 1m)</p> <p>Depth2: (Maximum depth of Depth1 + 1m) to (Minimum depth of Depth3 – 1m)</p> <p>Depth3: (Maximum depth of Depth2 + 1m) to (Minimum depth of Depth4 – 1m)</p> <p>Depth4: (Maximum depth of Depth3 + 1m) to (Minimum depth of Depth5 – 1m)</p> <p>Depth5: (Maximum depth of Depth4 + 1m) to (Minimum depth of Depth6 – 1m)</p> <p>Depth6: (Maximum depth of Depth5 + 1m) to (Minimum depth of Depth7 – 1m)</p> <p>Depth7: (Maximum depth of Depth6 + 1m) to 999m</p>
Current	Layer-A Layer-B Layer-C Layer-D Layer-E	<p>Set whether a current vector is to be displayed.</p> <p>Display of a current vector can be set to Enable/Disable for each of five layers, Layer-A to Layer-E.</p> <p>When a check mark is attached, the display is enabled and when a check mark is removed, the display is disabled.</p> <p>A display color is assigned to each layer.</p>	<p><u>Enable</u></p> <p>Disable</p>

Item	Setting contents	Setting value (Underline: Default value)
Maximum current	<p>Set a maximum current value to be attached to the track.</p> <p><u>Setting a maximum current value</u> Select a digit to be set by using   (Left/Right) keys and select a value by using the   (Up/Down) keys. After changing the value, determine the setting by pressing the  (Center) or  key.</p>	0.10kn to <u>5.00kn</u> to 9.99kn
Old track display	<p>Set whether an old track is to be displayed.</p> <p>If a check mark is attached, this item is enabled and if a check mark is removed, this item is disabled.</p>	<u>Enable</u> Disable
Old track date	<p>Set a date of old track.</p> <p><u>Setting a date</u> Select a digit to be set by using   (Left/Right) keys and select a value by using the   (Up/Down) keys. After changing the value, determine the setting by pressing the  (Center) or  key.</p>	00.01.01 to 99.12.31
ARPA(TT) track save	<p>Set whether a track of other ship is to be recorded by ARPA (Automatic Radar Plotting Aids).</p> <p>If a check mark is attached, this item is enabled and if a check mark is removed, this item is disabled.</p>	<u>Enable</u> Disable
ARPA track display	<p>Set whether a track of other ship is to be displayed by ARPA.</p> <p>If a check mark is attached, this item is enabled and if a check mark is removed, this item is disabled.</p>	<u>Enable</u> Disable
ARPA track delete	<p>Delete display of other ship from the screen by ARPA.</p> <p>When this item is selected, [Yes] [No] is displayed.</p> <p>To delete the display, select [Yes].</p>	Yes <u>No</u>
Thickness	Set a thickness of the track.	<u>1 dot</u> 2 dot 3 dot

Item		Setting contents	Setting value (Underline: Default value)
Time		Set an interval for recording a track with time or distance.	1s./2s./5s./ <u>10s.</u> /20s./30s./ 1m./2m./5m./10m./20m./ 30m./60m./0.01/0.02/0.05/ 0.1/0.2/0.5/1.0/2.0/5.0/ 10.0
Delete track	All	Delete all the tracks that are displayed. When this item is selected, [Yes] [No] is displayed. To delete all the tracks, select [Yes].	Yes <u>No</u>
	Date	Delete old tracks including the specified date. <u>Setting a date</u> Select a digit to be set by using   (Left/Right) keys and select a value by using the   (Up/Down) keys. After changing the value, determine the setting by pressing the  (Center) or  key. If there is a track applicable to the set date, [Yes][No] is displayed. To delete the track, select [Yes].	00.01.01 to 99.12.31
	Color	Delete the track of the specified color. If there is a track of the selected color, [Yes][No] is displayed. To delete the track, select [Yes].	7 colors available for tracks

5.6 Drawing lines

The plotting function of this equipment enables the following:

- Draw a line on a map.
- Draw a polygon by enclosing with lines and filling with a color.
- Write characters.

It is possible to draw up to 100,000 points, including 50,000 points for a line and 50,000 points for a filled polygon.

Characters can be written to 5000 sections.

5.6.1 Setting a plotting mode

When a main screen is displayed by splitting, activate the map screen and operate as follows.

1 Press the (Menu) key.

A map screen menu is displayed.



2 Select [User line drawing] and confirm the selection by pressing the , , or key.

The number of endpoints of the current line, the number of characters, and the current drawing mode are displayed at the left top corner of the screen.

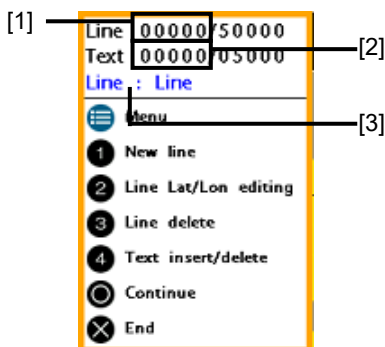

[1] Number of endpoints of the line that is currently drawn.

This information indicates the number of points that have been drawn out of 50,000 points in maximum.

[2] Number of sections in which characters that have been written

This information shows the number of sections in which characters have been written out of 5000 sections in maximum.

[3] Current drawing mode

Line: Mode for drawing a line

Fill: Mode for drawing a polygon enclosing with lines and filling with a color

5.6.1.1 Displaying a plotting menu

Press the  (Menu) key.

A plotting menu is displayed.

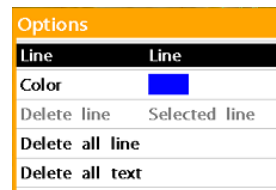

To clear the menu, press the  key.

To end the plotting mode, press the  key again.

5.6.2 Drawing a line





1 Set a plotting mode and display a plotting menu.

See Section 5.6.1 "Setting a plotting mode".

2 Select [Line] and press the , , or key.

3 Select [Line] and confirm the selection by pressing the , , or key.

4 Select [Color] and press the , , or key.

- 5 Select a required color and confirm the selection by pressing the  (Center), , or  key.
- 6 Close the menu by pressing the  key.
- 7 Move the cursor to the starting point of the line and press a numeric key [1].
- 8 Move the cursor to the ending point and press the  key.
A line is drawn connecting the starting point and the ending point.

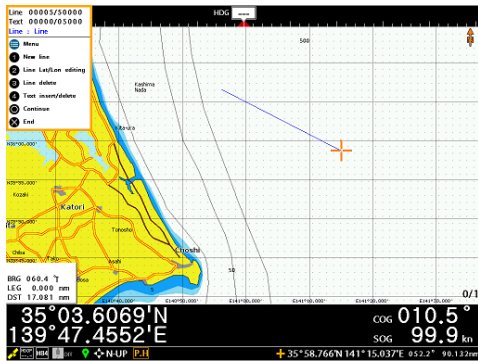

When drawing a next line by using this ending point as the starting point, proceed with Step 9.





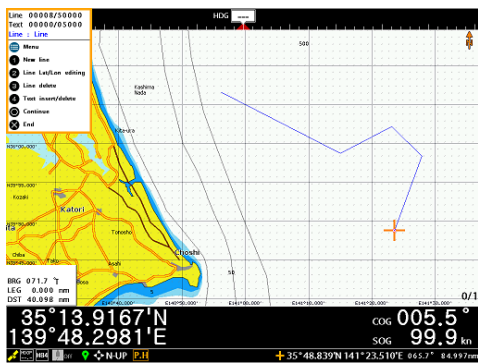









To end the processing, end the plotting mode by pressing the  key.

- 9 Move the cursor to the next ending point and press the  key.
- 10 Draw a broken line by repeating Step 9.



- 11 End the plotting mode by pressing the  key.

5.6.3 Drawing a polygon

- 1 Set a plotting mode and display a plotting menu.
See Section 5.6.1 “Setting a plotting mode”.
- 2 Select [Line] and press the  (Center), , or  key.
- 3 Select [Fill] and confirm the selection by pressing the  (Center), , or  key.
- 4 Select [Color] and confirm the selection by pressing the  (Center), , or  key.
- 5 Select a required color and confirm the selection by pressing the  (Center), , or  key.
- 6 Clear the menu by pressing the  key.
- 7 Move the cursor to the drawing starting position and press numeric key [1].
- 8 Move the cursor to the initial vertex and press the  key.
- 9 Move the cursor to the next vertex and press the  key.
The triangle that is created by using the three vertices that are specified in Steps 7 to 9 is filled with the selected color.

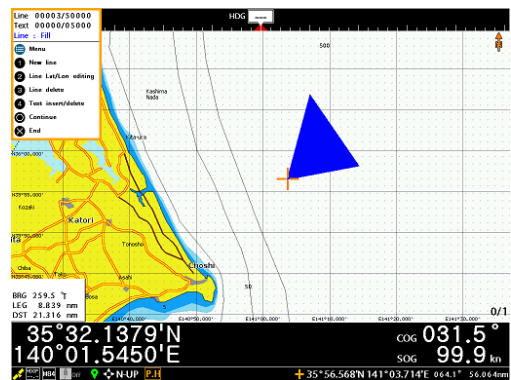

- To increase the number of vertices, move the cursor to the next vertex and press the **⊙** key.

Draw a required polygon by repeating this procedure.

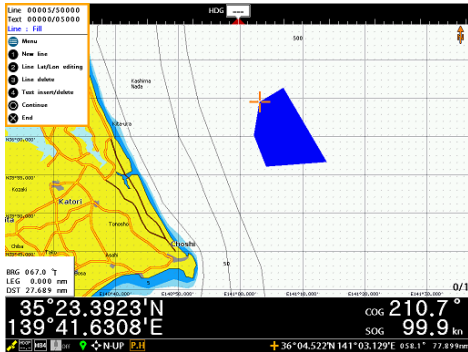

- End the plotting mode by pressing the **⊗** key.

5.6.4 Writing characters

- Set to a plotting mode and display a plotting menu.
See Section 5.6.1 “Setting a plotting mode”.
- Select [Color] and press the **⊕** (Center), **▶** (Right), or **⊙** key.
- Select a required color and confirm the selection by pressing the **⊕** (Center), **▶** (Right), or **⊙** key.
- Close the menu by pressing the **⊗** key.
- Move the cursor to the position to which a character is to be written and press numeric key [4].
A character selection screen is displayed.

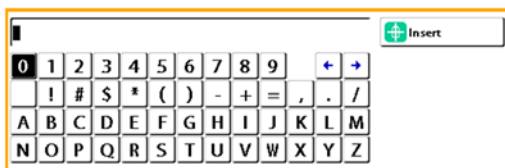

- Select a character by using the **▲** (Up), **▼** (Down), **▶** (Right), or **◀** (Left) key.

keys and confirm the selection by pressing the **⊕** (Center) key.

Create a required character string by repeating this operation.

To modify the character that has been input, select a character to be modified by using **◀** **▶** and select a character to be input after modification.



- Press the **⊙** key.
The character string is written in the cursor position.



- End the plotting mode by pressing the **⊗** key.

5.6.5 Deleting graphics and characters

5.6.5.1 Undisplaying graphics and characters

Graphics and characters can be hidden without deleting them.

- Press the **☰** (Menu) key.
A map screen menu is displayed.
- Select [User line display] and disable the item (remove the check mark).
Graphics and characters are undisplayed on the map screen.
To display them again, enable [User line display] (attach a check mark).

5.6.5.2 Deleting a specified line and a polygon

A line, a broken line, or a polygon can be deleted by specifying it.

There are two ways to delete.

Method 1: Delete by enclosing a line

- 1 Set a plotting mode.**
See Section 5.6.1 "Setting a plotting mode".
- 2 Set the cursor to the top left corner of the rectangle that encloses the line to be deleted.**
- 3 Press the numeric key [3].**
- 4 Set the cursor to the right bottom corner of the rectangle that encloses the line to be deleted.**
- 5 Press the  key.**
All the lines within the rectangle that is specified in Step 4 are deleted, including the lines that are partially included in the area.
For a polygon, the section that comprises the lines that are not included in the rectangle remain.

Method 2: Delete by selecting a line

- 1 Move the cursor to the point of the line to be deleted.**
Display the selected line with a small rectangle.
- 2 Press the  key.**
- 3 Select how to delete.**

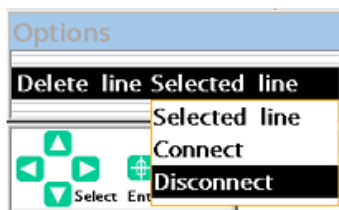

Selected line: Delete all one line.

Connect: Delete the selected point and lines, and connect adjacent points.

Disconnect: Delete the selected point and lines, and cut a line.

- 4 Press the  (Center),  (Right), or  key.**

5.6.5.3 Deleting a specified character string

Only the specified character string can be deleted.

- 1 Set a plotting mode.**
See Section 5.6.1 "Setting a plotting mode".
- 2 Set the cursor to the character string to be deleted.**
- 3 Press the numeric key [4].**
The character string is deleted.

5.6.5.4 Deleting all the lines

- 1 Set a plotting mode and display a plotting menu.**

See Section 5.6.1 "Setting a plotting mode".
- 2 Select [Delete all line] and confirm the selection.**
A confirmation message is displayed.
- 3 Confirm the selection by selecting [Yes].**

5.6.5.5 Deleting all the character strings

- 1 Set a plotting mode and display a plotting menu.**

See Section 5.6.1 "Setting to a plotting mode".

- 2 Select [Delete all text] and confirm the selection.
A confirmation message is displayed.
- 3 Confirm the selection by selecting [Yes].

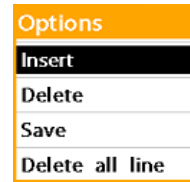

When inserting the continuation point, move the cursor to the line to be inserted and select [Insert] to add a line.

When deleting the continuation point, move the cursor to the line to be deleted. Select [Delete] to delete the continuation point.

When deleting all entered lines, select [Delete all line] to delete all line currently being input.

5.6.6 Drawing lines while entering latitude and longitude

A line can be drawn while entering the numerical value of latitude and longitude.

- 1 Set a plotting mode.
See Section 5.6.1 "Setting a plotting mode".
- 2 Press the numeric key [2].
A list of points for a line is displayed.

No.	Lat	Lon
000		
001		
002		
003		
004		
005		
006		
007		
008		
009		
010		
011		
012		
013		

- 7 Select [Save] and press the (Center) key.
The line is registered.

- 3 Press the (Center) or key.
A screen for entering latitude and longitude is displayed.

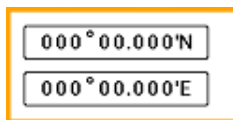

- 4 Enter latitude and press the (Center) or key, enter longitude and press the (Center) or key.
Latitude and longitude are displayed in the list.
- 5 Repeat step 4 and add the continuation point.
- 6 After entering the last point, press the (Menu) key.
The line menu is displayed.

5.7 Registering a mark (destination)

By registering a mark on the map, a mark can be set on any position.



In this equipment, a mark can also be used by a destination (waypoint or final destination) of a route.

5.7.1 Registering a mark at the cursor position

When a main screen is displayed by splitting, activate the map screen before starting the following procedure.

- 1 Move the cursor to the position at which a mark is to be registered.
- 2 Press the  (Menu) key.
A map screen menu is displayed.



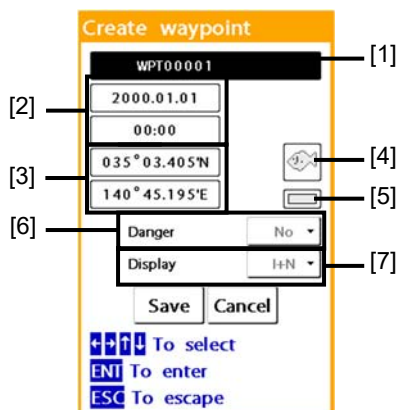

- 3 Select [New waypoint] and confirm the selection by pressing the  (Center),  (Right), or  key.
The [Create waypoint] screen is displayed.
The following information items relating to mark are displayed.



- [1] Name of the mark
- [2] Mark registration date and time
- [3] Latitude/longitude (current cursor position)
- [4] Mark shape
- [5] Mark color
- [6] [Danger] setting
- [7] [Display] setting

Memo

For the mark information change procedure, See Section 7.1.1 "Setting the [Create waypoint] screen".

- 4 Select [Save] and confirm the selection by pressing the  (Center) or  key.
The mark is registered at the cursor position.

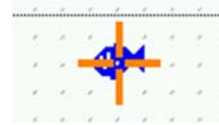





To cancel mark registration, select [Cancel] and determine the cancellation.

5.7.1.1 Checking registered marks

Registered marks are displayed in the [Waypoints] list.

- 1 Hold down the  (Screen) key.
A page menu is displayed.



- 2 Select [Waypoints] by using the   (Left/Right) keys and press the  (Center) or  key.
A [Waypoints] list is displayed, showing the registered marks.

Name	Date	Latitude	DST	rin	Disgr
WPT00002	2000.01.01	32°54.529'N	454.8	No	
WPT00002	00:00	150°13.089'E	242.8	No	
WPT00002	2000.01.01	35°35.247'N	34.8	No	
WPT00002	00:00	130°43.624'E	344.1	No	
WPT00004	2000.01.01	45°04.022'N	138.2	No	
WPT00004	00:00	145°00.659'E	26.2	No	
WPT00005	2000.01.01	32°40.888'N	182.2	No	
WPT00005	00:00	100°20.164'E	215.1	No	
WPT00006	2000.01.01	34°33.886'N	232.8	No	
WPT00006	00:00	135°24.399'E	245.2	No	
WPT00007	2000.01.01	38°15.236'N	202.2	No	
WPT00007	00:00	141°03.613'E	14.5	No	
WPT00008	2000.01.01	24°18.613'N	1001.8	No	
WPT00008	00:00	123°43.879'E	232.8	No	

- 3 Close the page menu by pressing the  key.

5.7.2 Registering a mark at the own ship's position

A mark can be registered at the own ship's position on the map with a simple key operation.

5.7.2.1 Registering a mark while the map is displayed

- 1 Hold down the  (Mark) key.







A mark is registered at the own ship's position.

Memo



The shape of the mark that is registered by holding down the  (Mark) key can be set in the [Chart] menu of the System Configuration menu. For the details, see the "Default mark" item in Section 8.3 "Setting map display – Chart menu".

5.7.2.2 Registering a mark in the [Waypoints] list

A new mark can be registered at the own ship's position while the [Waypoints] list is displayed.

- 1 Hold down the  (Screen) key.
A page menu is displayed.
- 2 Select [Waypoints] by using the   (Left/Right) keys and press the  (Center) or  key.
- 3 Hold down the  (Menu) key.
The following menu is displayed.





- 4 Select [Create] and confirm the selection by pressing the  (Center),  (Right), or  key.

The [Create waypoint] screen is displayed.

This screen is the same as that displayed when [New waypoint] is selected in the map screen menu.

Memo

For the procedure for changing the information relating to the mark that is displayed on the [Create waypoint] screen, see Section 7.1.1 "Setting the [Create waypoint] screen".

- 5 Select [Save] and confirm the selection by pressing the  (Center) or  key.

The newly registered mark is added to the [Waypoints] list.

- 6 Close the page menu by pressing the  key.



The new mark has been registered in the own ship's position.

5.7.3 Editing a mark

5.7.3.1 Changing names, positions, and shapes collectively

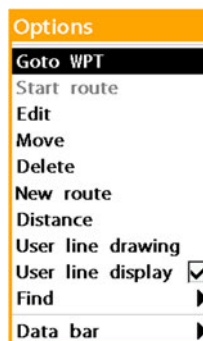
- 1 Set the cursor to the mark to be edited.
- 2 Press the  (Menu) key.
The following menu is displayed.



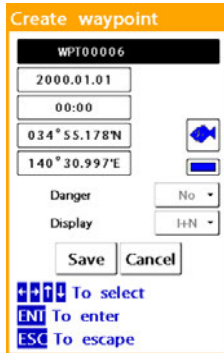

- 3** Select [Edit] and confirm the selection by pressing the  (Center), , or  key. The [Create waypoint] screen is displayed.



- 4** Select an item to be changed by using the  (Up/Down/Left/Right) keys and change the contents.



For the information on the mark and the changing procedure, see Section 7.1 "Map Screen menu".

- 5** Select [Save] and confirm the selection by pressing the  (Center) or  key.

5.7.3.2 Moving a mark

- 1** Set the cursor to the mark to be moved.
- 2** Press the  (Menu) key. The following menu is displayed.



- 3** Select [Move] and confirm the selection by pressing the  (Center) or  key.

- 4** Move the cursor to the target position of the mark and press the  key.

5.7.4 Deleting a mark

The registered mark is retained even if the power supply of the equipment is turned off. To delete the mark from the equipment, use the following procedure.

Memo

The mark that is currently used in the route cannot be deleted. By deleting the route containing the mark to be deleted, the mark can be deleted.





5.7.4.1 Deleting a mark by specifying it on the map

- 1** Set the cursor to the mark to be deleted. The selected mark flashes on and off.
- 2** Press the  key. The selected mark is deleted.

Memo

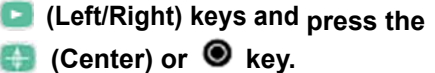
By setting "Delete waypoint confirm" item in Section 8.14 "Setting others - Others menu", a confirmation message is displayed when deleting.

5.7.4.2 Deleting a mark from the [Waypoints] list

- 1** Hold down the  (Screen) key. A page menu is displayed.
- 2** Select [Waypoints] by using the  (Left/Right) keys and press the  (Center) or  key. The marks that are registered in the [Waypoints] list is displayed.
- 3** Select a mark to be deleted (not displayed in reverse video).
- 4** Press the  (Menu) key. The following menu is displayed.



- 5 Select [Delete] and confirm the selection by pressing the (Center), (Right), or key.

A confirmation message is displayed.

- 6 Select [Yes] and confirm the selection by pressing the (Center) or key.

The specified mark is deleted from the [Waypoints] list and map.

To cancel the deletion, select [No] and determine the cancellation.

5.7.4.3 Deleting all the marks

Memo

When there is a mark that is used in the route, the following operation cannot be performed. Delete the route before deleting all the marks collectively.

- 1 Hold down the (Screen) key.
A page menu is displayed.
- 2 Select [Waypoints] by using the (Left/Right) keys and press the (Center) or key.
The marks that are registered in the [Waypoints] list are displayed.
- 3 Press the (Menu) key.
- 4 Select [Delete All] and confirm the selection by pressing the (Center), (Right), or key.
A confirmation message is displayed.

- 5 Press [Yes] and confirm the selection by pressing the (Center) or key.
All the marks are deleted from the [Waypoints] list and the map.
To cancel the deletion, select [No] and determine the cancellation.

5.7.5 Other operation procedures relating to marks

5.7.5.1 Displaying any mark at the center of the map.



- 1 Hold down the (Screen) key.
A page menu is displayed.
- 2 Select [Waypoints] by using the (Left/Right) keys and press the (Center) or key.
The registered marks are displayed in the list.
- 3 Select the mark at the destination (display in reverse video).
- 4 Hold down the (Menu) key.
The following menu is displayed.



- 5 Select [Display] and confirm the selection by pressing the (Center) or key.
- 6 The selected mark is displayed at the center of the map.

5.7.5.2 Searching a mark with the name

- 1 Hold down the (Screen) key.
A page menu is displayed.



- 2** Select [Waypoints] by using the  (Left/Right) keys and press the  (Center) or  key.

The registered marks are displayed in the list.

- 3** Press the  (Menu) key.



The following menu is displayed.

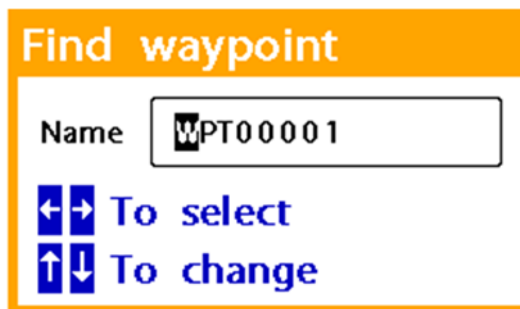

- 4** Select [Find] and confirm the selection by pressing the  (Center) or  key.

The following setting screen is displayed.



- 5** Select a character to be changed by using the  (Left/Right) keys, change the character by using the  (Up/Down) keys, and confirm the change by pressing the  (Center) key.



It is not possible to change to the character that is not used by any mark name.

- 6** Press the  key.

The mark of the selected name is displayed in reverse video.

- 1** Hold down the  (Screen) key.

A page menu is displayed.



- 2** Select [Waypoints] by using the  (Left/Right) keys and press the  (Center) or  key.

The registered marks are displayed in the list.

- 3** Press the  (Menu) key.

The following menu is displayed.



- 4** Select [Sort by] and confirm the selection by using the  (Center),  (Right), or  key.



Select a sorting condition from the following:

[Name]: Sort according to the mark name.

[Time]: Sort according to the mark registration date/time.

[Distance]: Sort according to the mark distance.

[Icon]: Sort according to the mark shape.

- 5** Confirm the selection by pressing the  (Center) or  key.





The marks in the [Waypoints] list are sorted according to the selected condition.

5.7.5.3 Sorting marks



Marks in the [Waypoints] list can be sorted with the specified condition.

5.7.5.4 Displaying only the marks registered during the specified period

By specifying a range of the mark registration dates, the marks that were registered outside of the range can be hidden on the map (filter function).



- 1 Hold down the  (Screen) key.
A page menu is displayed.
- 2 Select [Waypoints] by using the  (Left/Right) keys and press the  (Center) or  key.
The registered marks are displayed in the list.
- 3 Press the  (Menu) key.
The following menu is displayed.





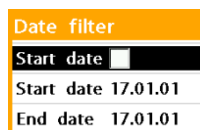

- 4 Select [Date filter] and confirm the selection by using the  (Center),  (Right), or  key.

The following screen is displayed.

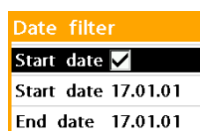





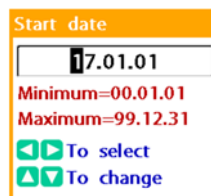

- 5 Select [Start date] on the right side of the check box and press the  (Center),  (Right), or  key.
A check mark is attached and the filter function is enabled.







- 6 Select [Start date] in the following line and press the  (Center),  (Right), or  key.



- 7 Specify a first date of the mark registration period.
Select a digit to be set by using the  (Left/Right) keys, change the value by using the  (Up/Down) keys, confirm the change by using the  (Center) or  key.

- 8 Select [End date] and press the  (Center),  (Right), or  key.

- 9 Specify a last date of the mark registration period.
Select a digit to be set by using the  (Left/Right) keys, change the value by using the  (Up/Down) keys, confirm the change by using the  (Center) or  key.

- 10 Close the page menu by pressing the  key repeatedly.
Only the marks that were registered within the specified period are displayed on the map.

To return to all the marks to the display state, remove the check mark in [Start date] in Step 5 and close the page menu by pressing the  key repeatedly.

5.8 Setting a route

A route refers to a Sea Lane with waypoints set between the starting point and the destination. Route navigation is the method where a route is set and the next waypoint is defined as the target whenever the waypoint that was set is passed through.



When route navigation starts, this equipment monitors the relationship between own ship and the route. When own ship deviates from the route, the equipment can issue an alarm.

5.8.1 Setting a route directly on the map

A new mark can be registered and also a route can be set on the map regardless of the presence or absence of a registered mark.

- 1 Press the  (Menu) key.
A map screen menu is displayed.



- 2 Select [New route] and confirm the selection by using the  (Center),  (Right), or  key.









A screen for setting a route name is displayed.



When no route is set, a name, [ROUTE01], is displayed.

Memo



A screen for setting a route name can also be displayed by holding down the  (Route) key instead of executing Steps 1 and 2.

- 3 To change the route name, select a character to be changed by using the   (Left/Right) keys, change the character by using the   (Up/Down) keys, and confirm the change by pressing the  (Center) key or  key.
- 4 Move the cursor to the first waypoint and press the  key.
A new mark is registered and this mark becomes the first waypoint.
When using this mark as the destination, proceed with Step 7.
- 5 Move the cursor to the next waypoint and press the  key.
- 6 Register waypoint marks by repeating Step 5.
- 7 After registering the last mark (destination), press the  key.
The route setting ends.

5.8.1.1 Checking the route that was set

- 1 Hold down the  (Screen) key.
A page menu is displayed.







- 2 Select [Routes] by using the  (Left/Right) keys and press the  (Center) or  key.
A [Routes] list is displayed and the routes that have been set are displayed.

Name	Start	End	Logs	DST(Trn)
ROUTE 01	WP100007	WP100012	0	49.3



- 3 Close the page menu by pressing the  key.

5.8.2 Creating a route by connecting marks

When a mark has already been registered, a route can be set by using the own ship's position as the starting point, and the mark position as a waypoint or a destination.



- 1 Hold down the  (Screen) key.
A page menu is displayed.
- 2 Select [Routes] by using the  (Left/Right) keys and press the  (Center) or  key.
- 3 Press the  (Menu) key.
The following menu is displayed.



- 4 Select [Create] and confirm the selection by using the  (Center),  (Right), or  key.





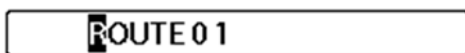

If no route has been set, a name [ROUTE01] is displayed in [Name].



- 5 To change the route name, press the  (Center) or  key.
Route name editing is enabled.





When not changing the route name, proceed with Step 7.

- 6 Select a character to be changed by using the  (Left/Right)

keys, change the character by using the  (Up/Down) keys, and confirm the change by pressing the  (Center) key or  key.

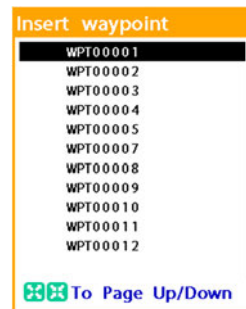
- 7 Press the  (Down) key, select the 1st row of the list, and confirm the selection by pressing the  (Center) or  key.
Registered marks are displayed in the list.





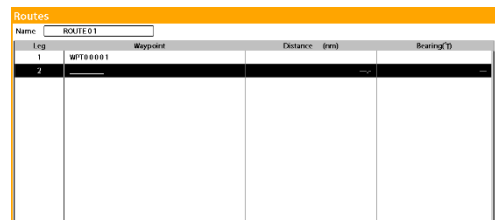

- 8 Select the first waypoint and confirm the selection by pressing the  (Center) or  key.





The next waypoint row is displayed in reverse video automatically.

When using the 1st row as the destination, proceed with Step 12.

- 9 Press the  (Center) or  key, and select the next waypoint by using the  (Up/Down) keys and confirm the selection by pressing the  (Center) or  key.







- 10 Add waypoints by repeating Step 9.





- 11 After registering the final waypoint (destination), press the  key.
The route setting is completed.

- 12** Close the page menu by pressing the  key.

5.8.3 Editing a route



A route name can be changed or a new waypoint can be inserted, or a waypoint can be deleted from the route.



- 1** Hold down the  (Screen) key.
A page menu is displayed.
- 2** Select [Routes] by using the  (Left/Right) keys and press the  (Center) or  key.
A [Routes] list is displayed.
- 3** Select a route to be edited and confirm the selection by pressing the  (Center) or  key.

Alternatively, after selecting a route to be changed, press the  (Menu) key, select [Edit] from the menu that is displayed, and confirm the selection by using the  (Center),  (Right), or  key.

The name of the route is selected (displayed in reverse video).













Memo

When only one route has been set, determine the setting by pressing the  key or press the  (Menu) key, and confirm the selection by selecting [Edit] from the menu that is displayed.





- 4** To change the name of the route, press the  (Center) or  key.
Alternatively, press the  (Menu) key, select [Edit] from the menu that is displayed, and confirm the selection.
The route name editing is enabled.

ROUTE 01

To edit the waypoint without changing the route name, proceed with Step 6.

- 5** Select a character to be changed by using the   (Left/Right) keys, change the character by using the   (Up/Down) keys, and confirm the change by pressing the  (Center) key or  key.
- 6** Select a mark one below the waypoint insertion position and press the  (Center) or  key.
Alternatively, press the  (Menu), select [Insert] from the menu that is displayed, and confirm the selection by pressing the  (Center),  (Right), or  key.
Registered marks are displayed in the list.



- 7** Select a mark to be inserted and confirm the selection by pressing the  (Center) or  key.
To insert another mark, repeat Steps 6 and 7.
- 8** Press the  key.
The route editing is completed.
- 9** Close the page menu by pressing the  key.



5.8.3.1 Adding a waypoint on the map





Add a new waypoint following the current destination.

The current destination becomes a waypoint and the final waypoint that was added becomes the destination.

- 1** Hold down the  (Screen) key.

A page menu is displayed.

- 2 Select [Routes] by using the  (Left/Right) keys and press the  (Center) or  key.

- 3 Select a route to be edited, press the  (Menu) key, select [Edit on chart] from the menu that is displayed, and press the  (Center),  (Right), or  key.

- 4 Move the cursor to the new waypoint position and press the  key.





To use this waypoint as the destination, end the route editing by pressing the  key.



To add another waypoint, proceed with Step 5.





- 5 Add as many waypoints as necessary by repeating Step 4.

- 6 Press the  key.
The route editing ends by using the last waypoint that was added as the destination.

5.8.3.2 Deleting a waypoint

- 1 Hold down the  (Screen) key.
A page menu is displayed.
- 2 Select [Routes] by using the  (Left/Right) keys and press the  (Center) or  key.

- 3 Select a route to be edited and press the  (Center) or  key.

- 4 Select a waypoint to be deleted by using the  (Up/Down) keys, press the  (Menu) key, select [Remove] from the menu that is displayed, and confirm the selection by using the  (Center),  (Right), or  key.

- 5 Press the  key.

The route editing ends.

- 6 Close the page menu by pressing the  key.





5.8.4 Deleting a route

The route that has been set is kept even if the power supply of the equipment is turned off. To delete a route from the equipment, use the following procedure.





Memo

The route that is currently used by route navigation cannot be deleted.



5.8.4.1 Deleting a route by selecting from the [Routes] list

- 1 Hold down the  (Screen) key.
A page menu is displayed.
- 2 Select [Routes] by using the  (Left/Right) keys and press the  (Center) or  key.

The  mark is displayed on the left side of the route name that is being used by the route navigation.

- 3 Select a route to be deleted, press the  (Menu) key, select [Delete] from the menu that is displayed, and confirm the selection by using the  (Center),  (Right), or  key.











A confirmation message is displayed.

- 4 Select [Yes] and confirm the selection by pressing the  (Center) or  key.
To cancel deletion, select [No] and confirm the selection.

5.8.4.2 Deleting all the routes

Memo









When there is a route that is being used by route navigation, this operation is disabled. End route navigation before deleting all the routes collectively.

- 1 Press the  (Screen) key.
A page menu is displayed.
- 2 Select [Routes] by using the  (Left/Right) keys and press the  (Center) or  key.
- 3 Press the  (Menu) key, select [Delete All] from the menu that is displayed, and confirm the selection by using the  (Center),  (Right), or  key.
A confirmation message is displayed.
- 4 Select [Yes] and confirm the selection by pressing the  (Center) or  key.
To cancel deletion, select [No] and confirm the selection.

5.8.5 Other operations relating to route

5.8.5.1 Displaying a specified route on the map

After a route is specified, the map can be moved so that the route is displayed.

- 1 Hold down the  (Screen) key.
A page menu is displayed.
- 2 Select [Routes] by using the  (Left/Right) keys and press the  (Center) or  key.
- 3 Select a route to be displayed, press the  (Menu) key, select [Display] from the menu that is displayed, and confirm the selection by using the  (Center),  (Right), or  key.



5.8.6 Creating a temporary route

A temporary route is not stored in the equipment.





When a temporary route is created, route navigation starts automatically without route navigation starting operation.

Memo





A temporary route is cleared when the power supply of the equipment is turned off.

- 1 Move the cursor to the first waypoint and press the  (Starting point).
This position becomes the first waypoint.
- 2 Move the cursor to the next waypoint and press the  (Starting point) key.
- 3 Add waypoints by repeating Step 2.
Up to 100 waypoints can be specified.
- 4 After setting the last waypoint (destination), press the  (Final point) key.
The temporary route is determined and route navigation starts by using this route.

When a mark is registered, a temporary route that uses any mark as the destination can be created by using the following procedure.

- 1 Set the cursor to the mark that is used as the destination and press the  (Menu) key.
- 2 Select [Goto WPT] and confirm the selection by using the  (Center),  (Right), or  key.
Route navigation starts.

5.8.6.1 Canceling route navigation by using a temporary route

Press the  (Menu) key, select [Cancel route] from the menu that is displayed, and confirm the selection by using the  (Center),  (Right), or  key.

Alternatively, hold down the  (Starting point) key.

5.8.7 Creating a temporary destination

A temporary destination is not stored in the equipment.

When temporary destination is created, route navigation from own ship to the temporary destination automatically starts.





Memo

A temporary destination is cleared when the power supply of the equipment is turned off.

- 1 Move the cursor to the destination and press the  (Ending point) key.





A temporary destination is displayed.

The following operations are also available in addition to the above operation.

- 1 Move the cursor to the destination and press the  (Menu) key.
- 2 Select [Goto cursor] from the menu and confirm the selection by using the  (Center),  (Right), or  key.

Route navigation starts.

5.8.7.1 Canceling route navigation to a temporary destination

Press the  (Menu) key, select [Cancel route] from the menu that is displayed, and confirm the selection by using the  (Center),  (Right), or  key.





Alternatively, hold down the  (Starting point) key.

5.9 Starting/ending route navigation

5.9.1 Starting route navigation

If one or more routes are set, route navigation can be started.



5.9.1.1 Starting route navigation on the map

- 1 Press the  (Menu) key.
- 2 Select [Start route] and press the  (Center),  (Right), or  key.

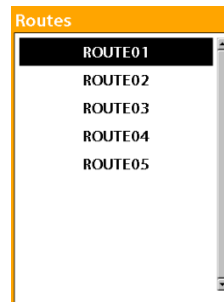
The routes that are set are displayed in the list.





A route list can also be displayed by pressing the  (Route) key instead of Steps 1 and 2.

- 3 Select a route to be used for route navigation and press the  (Center) or  key.





A route direction selection screen is displayed.





- 4 To use the route in the order from the starting point to the destination, select [Forward] and to use the route in the order from the destination to the starting point, select [Reverse], and confirm the selection by pressing the  (Center) or  key.

Route navigation starts by using the selected route.



5.9.1.2 Starting route navigation from the route list

- 1 Hold down the  (Screen) key. A page menu is displayed.
- 2 Select [Routes] by using the  (Left/Right) keys and press the  (Center) or  key. A [Routes] list is displayed.
- 3 Select a route to be used for route navigation and press the  (Menu) key. The following menu is displayed.



- 4 Select [Start] and press the  (Center),  (Right), or  key. A route direction selection screen is displayed.



- 5 To use the route in the order of the starting point to the destination, select [Forward] and to use the route in the order from the destination to the starting point, select [Reverse], and confirm the selection by pressing the  (Center) or  key. Route navigation starts by using the selected route.

5.9.1.3 Map screen during route navigation

During the route navigation, own ship and the route are displayed as shown below.

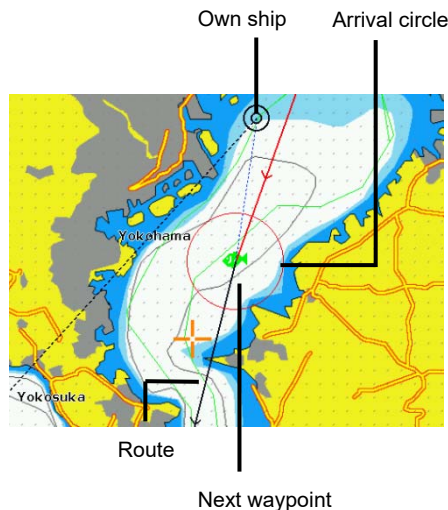

5.9.1.4 Navigation alarms



This equipment monitors the following information items during route navigation and issues an alarm as required.

Memo
Set information on alarms in the System Configuration menu. For the details, see the item, "Navigation alarms", in Section 8.12 "Setting alarms – Alarms menu".

Waypoint alarm

Set an arrival circle based on the route destination so that an alarm is issued when own ship enters into or exits from the range of the arrival circle.

In this case, the one of the following icons are displayed on the status bar.

- : Own ship entered into the arrival circle.
- : Own ship exited from the arrival circle.

When the ship enters in an alarm issuing state, the icon turns to red.

Anchor alarm

Set a circular monitoring area around own ship so that an alarm is issued when own ship exited from the monitoring area.

XTE alarm

An alarm is issued when own ship entered into or exited from the route width.

In this case, one of the following icons is displayed on the status bar.

: Own ship entered into the route width.

: Own ship exited from the route width.

When the ship enters in an alarm state, the background of the rectangle icon becomes red.

Danger

A circular monitoring area is set around the mark (destination) and when own ship enters in the monitoring area, an alarm is issued.

A circle of different size from that of Anchor alarm can be set.



Memo

Set information on alarms during navigation in the System Configuration menu. For the details, see “Navigation alarms” in Section 8.12 “Setting alarms – Alarms menu”.

5.9.2 Operating a route

The following operations are available during route navigation.

5.9.2.1 Skipping a waypoint

- 1 Press the  (Menu) key.
- 2 Select [Skip] and press the  (Center) or  key.

The current waypoint is skipped and a new route is created by connecting the next waypoint and own ship.

5.9.2.2 Re-setting a cross-track error





XTE is re-set from the position where the following operations are executed.

Memo

At the factory delivery, the route width that causes an exit alarm (cross-track error) is set to 0.10nm for both the starboard side and the port side.

The exit alarm is set to Disable.





To enable the exit alarm, see “Navigation alarms” in Section 8.12 “Setting alarms – Alarms menu”.

- 1 Press the  (Menu) key.
- 2 Select [Reset XTE] and press the  (Center),  (Right), or  key.

5.9.3 Ending route navigation

To interrupt the route navigation that is being executed, use the following procedure.

5.9.3.1 Ending route navigation by using a menu

- 1 Press the  (Menu) key.
- 2 Select [Cancel route] and press the  (Center),  (Right), or  key.

5.9.3.2 Ending route navigation by using a key

Hold down the  (Starting point) key.

5.10 Switching a map

When both of a new pec card and a Navionics card are inserted, the map to be displayed can be switched in the following procedure.

Memo

When the map is switched, the equipment restarts. However, in the same way as for power supply On/Off, most of the settings on the menus and the destination and routes that have been saved remain unchanged. However, if the map is switched during route navigation, the route navigation that is being executed is interrupted.

The main screen becomes P.H after map switching no matter which main screen on which the operation is performed.

1 Hold down the (Menu) key.

The System Configuration menu is displayed.

System Configuration	
System Configuration	▶
Own ship	▶
Chart	▶
Sonar	▶
GPS	▶
Track & Log	▶
Communication	▶
AIS	▶
ARPA(TT)	▶
DSB(TT)	▶
GPS Buoy	▶
Alarms	▶
Memory	▶
Others	▶

2 Select [System Configuration] and confirm the selection by pressing the , , or key.

The [System Configuration] menu is displayed.

System Configuration	
Language	English
Chart	Newpec
Key Beep	On
Key light	Auto
Arrow key	Normal
Input time over	Off
Trackball	Normal
Data bar mode type	- 1
Units	▶
Factory Reset	▶
About	

3 Select [Chart] and confirm the selection by using the , , or key.

A map selection screen is displayed.

Newpec
Navionics

4 Select a map to be displayed and confirm the selection by using the , , or key.

This equipment restarts and the main screen becomes P.H and the selected map is displayed.



Section 6 How to Use Various Screens

This section describes how to customize screens and how to interpret and use the screens other than the map screen.

Noations of the operation procedure

In this Section, the menu operation procedures may be described by simplifying them according to the following notation standards.

No.	Notation	Operation contents	Example
1	(Hold down screen key)	Hold down the (Screen) key.	-
2	Operate in the order of (Hold down the screen key) - [Waypoints].	Hold down the (Screen) key and when a page menu is displayed, select the [Waypoints] button by using the (Left/Right) keys and confirm the selection by using the (Center) or key.	-
3	Select	Set the item to highlighted display by using the (Up/Down/Left/Right) keys.	Select [Data bar setup].
4	Confirm	Confirm the selected item by using the (Center) or key.	Confirm [Data bar setup].
5	Select and confirm	Consecutive operation of Nos. 3 and 4.	Select [Data bar setup] and confirm the selection.
6	Enable	Attach a check mark by perssing the (Center), (Right), or key.	-
7	Disable	Remove the check mark by pressing the (Center), (Right), or key.	-

Page menu buttons













When the  (Active screen) key is held down, the following page menu is displayed.



When the  (Screen) key is pressed, the following page menu is displayed.



Each button in the page menu is expressed as follows in this manual.

Button	Notation	Button	Notation	Button	Notation
	[Add] button		[Waypoints] button		[AIS] button
	[Remove] button		[Routes] button		[DSB] button
	[Replace] button		[Satellite] button		[Navtex] button
	[Split] button		[Tides] button		[Page draw settings] button

6.1.1.2 Setting a data bar

Up to 12 types of information can be displayed in the [type-1] data bar and the [type-2] data bar. Use the following procedure. (see Section 4.2.3 “Switching a data bar pattern”).

This section shows how to set information to be displayed in the [type-2] data bar as the example.

Initially, switch the data bar to [type-2].

1 Hold down the  (Data bar) key.

The following menu is displayed.

Data bar	
Layout	Layout-1
Data bar	<input checked="" type="checkbox"/>
Data bar setup	
Data bar position	down
Data bar mode	None
Background	Black
Data bar blank line display	<input type="checkbox"/>
Status bar	<input checked="" type="checkbox"/>
Compass	<input checked="" type="checkbox"/>
Compass (COG / HDG) set	HDG

2 Select [Data bar setup] and confirm the selection.

The top left area among the 12 areas on the data bar (type-2) is displayed in reverse video.

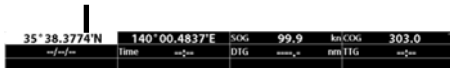

Reverse video



To set data to be displayed in this area, proceed with Step 4.



3 By using the  (Up/Down/Left/Right) keys, display the area whose display data is to be changed in reverse video.

4 Press the  (Center) or  key.

5 Select [Data type] and press the  (Center),  (right), or  key.

The information that can be displayed is displayed in the list.

- None
- Air temp
- AIS status
- Alarm status
- Baro
- Bearing
- CDI
- Course
- Crs to steer
- Date
- Depth
- Destination
- Dist to dest
- Dist to next
- Engine hour
- Engine voltage
- Engine temp
- ETA at dest
- ETA at next
- Fuel consumption
- Fuel economy
- Fuel flow
- Fuel level

6 Select data to be displayed and press the  (Center),  (Right), or  key.





To not display any data in the display area that was selected in Step 3, select [None].

The source is set to the changeable state according to the selected data (displayed in black).

Example: [Fuel consumption] is selected.

Data Setup	
Data type	Fuel consumption
Source	Port

When not changing the source, proceed with Step 8.

7 After selecting [Source] and pressing the  (Center) or  key, confirm the selection by pressing the  (Center),  (Right), or  key.



8 End the setting of this area by pressing the  key.

9 To change the setting of other display areas also, repeat Steps 3 to 8.

10 End the operation by pressing the  key.

6.1.2 Split display by adding a screen

When the main screen is in 1-screen display, 2-split display, or 3-split display mode, up to 4-split display modes can be applied by increasing the screens to be displayed.

- 1 **Activate the screen to be split by pressing the  (Active screen) key.**
- 2 **Operate in the order of  (Hold down the Active screen key) – [Add].**

The screens that can be added are displayed in the list.





Memo

Five screens can be added (screens that can be displayed on split screens), "Map", "Map 2", "Highway", [Data], [Depth], [Video].

- 3 **Select a screen to be added and confirm the selection.**

The active screen is split and the selected screen is added.



6.1.2.1 Deleting a screen

- 1 **Activate the screen to be deleted by pressing the  (Active screen) key.**
- 2 **Operate in the order of  (Hold down the active screen) – [Remove].**

The screen that was activated in Step 1 is deleted.

6.1.3 Replace with another screen

The screen can be replaced with another screen regardless of whether the main screen is one-screen display or split screen display.

- 1 **Activate the screen to be replaced with another screen by pressing the  (Active screen).**
- 2 **Operate in the order of  (Hold down the active screen) – [Replace].**

Screens that can be used for replacement are displayed in the list.







- 3 **Select a new screen to be displayed and confirm the selection.**

6.1.4 Moving a boundary of a split display screen

The size occupied by each screen can be changed by moving the screen boundary on the split display screen.

- 1 Operate in the order of  (Hold down the active screen) – [Split].
The following screen is displayed.



- 2 Move the boundary by using the     (Up/Down/Left/Right).
Keys.
- 3 End the operation by pressing the  key.

Example: The  (Up) key is pressed on the 3-split screen.

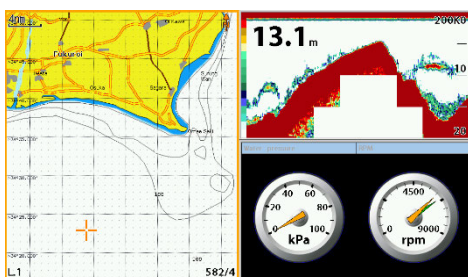
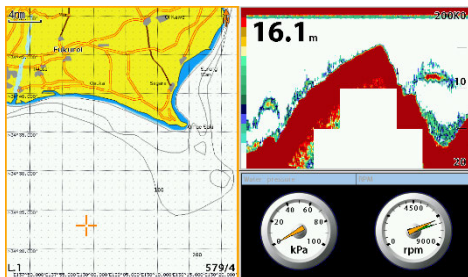

6.1.5 Setting an undisplay screen

Up to 10 display patterns are available for a main screen and the pattern number that is currently displayed (PH, P.1 to P.9) is displayed on the status bar.

Any pattern can be set to undisplay among the 10 display patterns. By setting to undisplay, the patterns that need not be switched are undisplayed at the screen switching by the  (Screen) key, eliminating unnecessary operations.

Memo

At the factory shipment, PH and P.1 to P.3 are set to display and P.4 to P.9 are set to undisplay. PH can be set to undisplay.

- 1 Operate in the order of  (Hold down the screen key) – [Page draw settings].

The following screen is displayed.

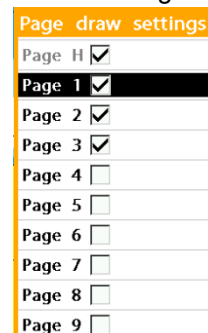

- 2 Enable the screen to be displayed and disable the screen to be undisplayed.

Show the screen whose [Page 1] is P.1 and show the screen whose [Page 9] is P.9.

- 3 End the operation by pressing the  key.

To reset the screen that was set to undisplay to display, repeat the operation indicated above, select the screen to be displayed in Step 2, and enable the selection.

6.1.6 Saving the screen that is currently displayed

The capture data that is currently displayed on the screen can be saved in the SD memory card that is set in this equipment.

Memo

Format the SD memory card to be used for saving capture data with the FAT or FAT32 file system. This equipment does not recognize the SD memory cards that are formatted in other file systems.

The SD memory card must be unlocked to enable write processing.

- 1 **Insert the memory card in SD card slot 1 (top) or card slot 2 (bottom).**
- 2 **Hold down the  (Day/Night) key while the screen to be captured is displayed.**

The file name of the capture data that is saved in the SD memory card is displayed for several seconds. The "SCRNSHOT" folder is automatically created in the SD memory card and the capture data is saved in the folder.

6.2 Highway screen

A highway screen visually displays the route in 3D under which route navigation is currently executed or used.

6.2.1 Information that is displayed on a highway screen

Memo

A highway screen can be displayed as one of the split screens.

The following information items are displayed on a highway screen.

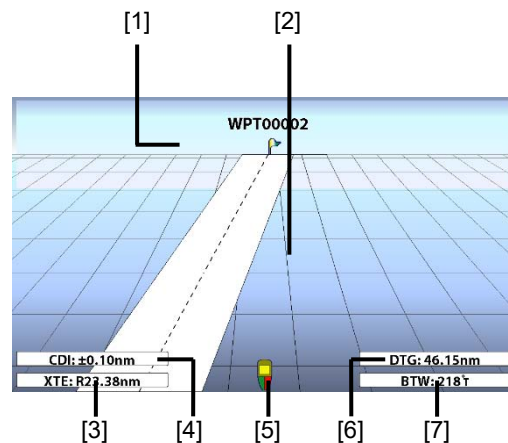

- [1] Next waypoint and the name
- [2] Route
- [3] XTE: Cross track distance
- [4] CDI: Width of the route alarm that is set
- [5] Own ship
- [6] DTG: Distance to the next waypoint
- [7] BTW: Bearing to the next waypoint

6.3 Data screen

On a data screen, numeric information that is obtained from various sensors of the ship is displayed in the form of gauges.

6.3.1 Customizing a data screen

Memo

A data screen can be displayed as one of split screens.

If a data screen is a 1-screen display or one of the left and right 2 split screens, 4 gauges are displayed. If a data screen is one of the top and bottom 2 split screens or one of the 4 split screens, 2 gauges are displayed.

The information items that can be displayed on a data screen in the form of gauges are indicated below.

A unit of the data is indicated in the gauge and most of them can be changed in the system setting menu.

Layouts 1 to 3:

Depth/Engine voltage/Engine temp/Fuel cons./Fuel eco./Fuel flow/Fuel level/Fuel remaining/GPS speed/Oil level/Oil temp/Oil pressure/RPM/Steer/Trim/Voltage/Water pressure/Water speed/Wind speed/XTE

Layouts 4 to 6:

Air temp/AIS status/Bearing/Course/Crs to steer/Depth/Dist to dest/Dist to next/Engine hour/Engine voltage/Engine temp/ETA at dest/ETA at next/Fuel cons./Fuel eco./Fuel flow/Fuel level/Fuel range/Fuel remaining/Fuel used/GPS speed/Heading/ Lat/Lon /Oil level/Oil temp/Oil pressure/RPM/Steer/Time/Time to dest/Time to next/Trim/Trip dist/Total dist/VMG/VPW/Voltage/Water pressure/Water speed/Water temp/Wind direction/Wind speed/XTE

Example of data screen

Name of instrument
(information)

Unit

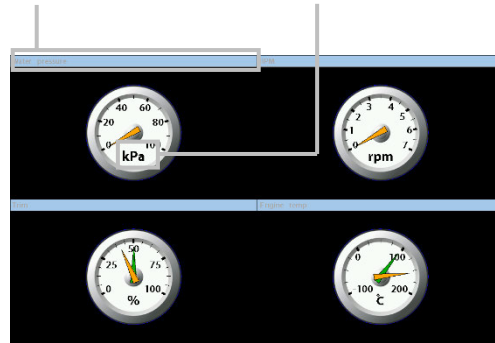



6.3.1.1 Switching a layout of a data screen

Six layouts are available for a data screen.

The relationship between the number of gauges that are displayed on a data screen and information layout is shown below.

Layout	No. of gauges	
	2	4
1	Water pressure RPM	Water pressure RPM Trim Engine temperature
2	Oil temperature Oil pressure	Oil temperature Oil pressure Voltage GPS speed
3	Current speed Water pressure	Current speed Water pressure RPM Remaining amount of fuel
4	AIS Time	AIS Time Ship's heading Latitude/longitude
5	Bearing Current speed	Bearing Current speed Engine voltage Engine temperature
6	VMG VPW	VMG VPW Oil temperature Oil pressure

Use the following procedure to switch a layout.

- 1 **Activate a data screen by using the  (Active screen).**
- 2 **Press the  (Menu) key.**
A data screen menu is displayed.

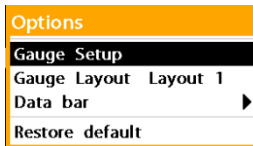

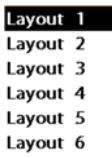

- 3 **Select [Gauge Layout] and confirm the selection.**
The following screen is displayed.



- 4 **Select a layout to be displayed and confirm the selection.**
- 5 **End the operation by pressing the  key.**

6.3.1.2 Setting display information of each gauge

Particular information of a particular gauge to be displayed on a data screen can be set freely.

- 1 **Activate a data screen by using the  (Active screen) key.**
- 2 **Press the  (Menu) key.**
A data screen menu is displayed.

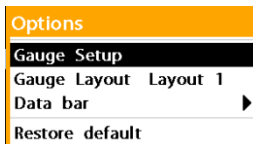



- 3 **Select [Gauge Setup] and confirm the selection.**

One of the gauge names is displayed in reverse video.

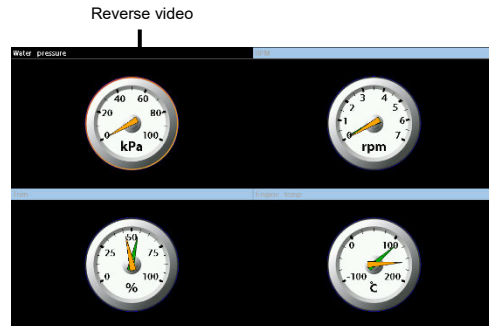
Example: Four gauges are displayed.



To change the display contents of the gauge, proceed with Step 5.

- 4 **Select a gauge whose display contents are to be changed by using the  (Up/Down/Left/Right) keys and press the  (Center) or  key.**

- 5 **Press the  (Center),  (Right), or  key.**

The information items that can be displayed on the gauge are displayed in the list.

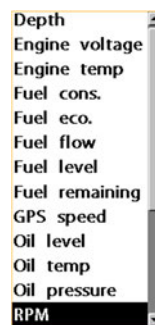





- 6 **Select information to be displayed and confirm the selection.**

Some selected information is set to a source change enable state (displayed in black).

Example: [Engine voltage] is selected.



Proceed with Step 8 when not changing the source.

7 Select [Source], change [Source] by pressing the  (Center) or  key, and confirm the selection by pressing the  (Center),  (Right), or  key.

8 Press the  key.
To end the operation at this point, proceed with Step 10.

9 To change the display information of another gauge, repeat Steps 4 to 8.

10 Press the  key and end the operation.

Memo

When the source is set to [Port], the color of the needle of the gauge becomes orange and when [Starboard] is set, the color of the needle becomes green. When [All] is set, two needles are displayed.

6.4 Sonar screen

Ultrasonic waves are discharged from the transducer that is installed in the bottom of the ship towards the sea bed to measure the condition of the sea bed.

A sonar screen displays the condition of the sea bed and the depth values that were obtained concurrently.

6.4.1 Information displayed on a sonar screen

Memo

A sonar screen can be displayed as one of the split screens.

A sonar screen can display the following information items.

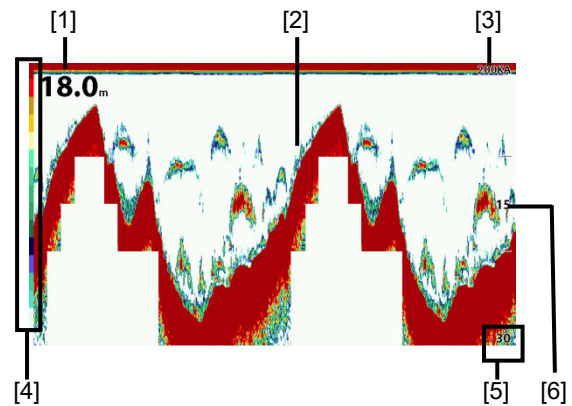

[1] Depth display

[2] Sea bed

[3] Transmission frequency

200KA (or 200K0): 200kHz

50KA (or 50K0): 50kHz

[4] Color sample of sea clutters (echoes)

The equipment displays the strength of echoes with color.

It is possible to set 16-color display or 8-color display.

[5] Range

The maximum depth that can be displayed is displayed.





When the range is set automatically, A is displayed following the transmission frequency (such as 200KA). When the range is set manually, 0 is displayed following the transmission frequency (such as 200K0).

[6] Sea bed point corresponding to the depth display

Sea bed display flows from the right to the left. The rightmost point of the screen corresponds to the depth that is currently measured.

6.4.2 Using a sonar screen

6.4.2.1 Switching a range

- 1 Activate a depth screen by pressing the  (Active screen) key.
- 2 Press the  (Zoom In)/ (Zoom Out) keys.
When the  (Zoom In) key is pressed, the range of the depth screen is expanded.
When the  (Zoom Out) key is pressed, the range of the depth screen is reduced.

6.4.2.2 Displaying sonar screens of two frequencies

Separately from a split main screen, a sonar screen can be split into two and sonar information of 50kHz and that of 200kHz can be displayed.

- 1 Activate a sonar screen by pressing the  (Active screen) key.

- 2 Press the  (Menu) key.

A sonar menu is displayed.

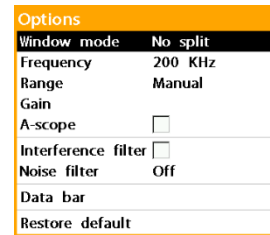

- 3 Select [Window mode] and confirm the selection.

The following screen is displayed.

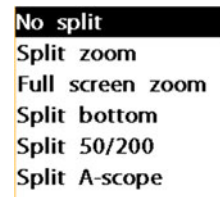

- 4 Select [Split 50/200] and confirm the selection.
- 5 End the operation by pressing the  key.

The sonar screen is split into two screens and the screen of frequency 50kHz is displayed on the left side and the screen of frequency 200kHz is displayed on the right side.

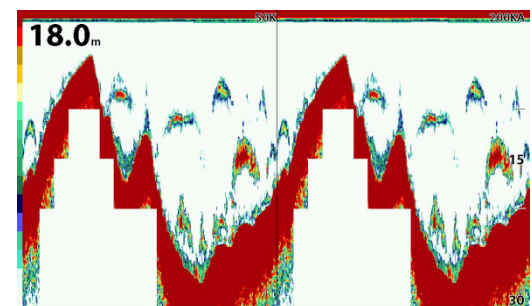

Memo

When [Split A-scope] is selected at Step 4 and the selection is confirmed, the depth screen is split into two sections, left and right, and the A-scope screen is displayed on the right side.

6.4.2.3 Changing the setting of a sonar screen

A sonar screen can be effectively used by changing various settings, other than splitting into the left and right sections.

See Section 7.4 “Sonar screen menu” and Section 8.4 “Setting a sonar Screen – Sonar menu”.

6.5 Video screen

Images taken by external video equipment that is connected to this equipment (such as monitoring camera) can be displayed on a screen of this equipment.

Memo

A video screen can be displayed as one of the split screens.



6.5.1 Setting the equipment according to the input signals

6.5.1.1 Setting the equipment according to the image signaling system

This equipment supports PAL and SECAM as well as NTSC, which is the image signaling system for the domestic market of Japan. Switch the signaling system by using the following procedure when inputting image signals from video equipment of PAL or SECAM system.

- 1 Select  (Hold down the Menu key) - [Others] and confirm the selection.

The [Others] menu is displayed.

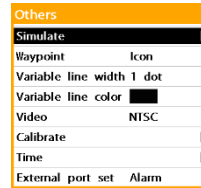

- 2 Select [Video] and confirm the selection.

The following screen is displayed.

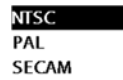



- 3 Select [PAL] or {SECAM} according to the video equipment to be used and confirm the selection.

- 4 End the operation by pressing the  key.

6.5.1.2 Setting the equipment according to the input signal type

This equipment supports composite signals and S-VIDEO signals. By connecting two cameras that output composite signals, images from the cameras can be displayed alternately. Set the equipment correctly according to the signals that are input.

- 1 Activate the video screen by pressing the  (Active screen) key.
- 2 Press the  (Menu) key. A video screen menu is displayed.

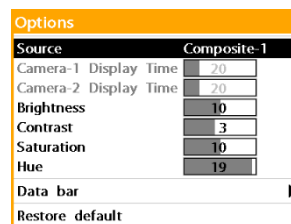

- 3 Select [Source] and confirm the selection.

The following screen is displayed.



4 Select a signal to be input and confirm the selection.

Composite-1: Video equipment (1st unit) that outputs signals is used.

Composite-2: Video equipment (2nd unit) that outputs composite signals is used.

S-VIDEO: Video equipment that outputs S-VIDEO signals is used.

Camera Scan: An image of the video equipment of Composite-1 and an image of video equipment of Composite-2 are displayed alternately.

5 End the operation by pressing the key.

6.5.2 Adjusting an image quality

Adjust the quality of the image that is displayed on the video screen.

Brightness, contrast, saturation, and hue can be adjusted.

1 Activate the video screen by pressing the (Active screen) key.

2 Press the (Menu) key.

A video screen menu is displayed.

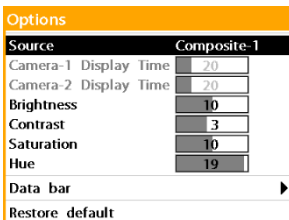

3 Select the item to be adjusted.

Select one of [Brightness], [Contrast], [Saturation], and [Hue] (displayed in reverse video).

4 Adjust by using the (Left/Right) keys.

Brightness: The higher the value, the brighter the image becomes.

Contrast: The higher the value, the stronger the contrast becomes.

Saturation: The higher the value, the stronger the color definition becomes.

Hue: The higher the value, the stronger the color definition and brighter the image become.

5 End the operation by pressing the key.

6.6 Satellite information screen

On a satellite information screen, the layout of the GPS satellite that can be currently used and the strength of signals can be checked.

Displaying/clearing a satellite information screen

To display a satellite information screen, operate in the order of  (Hold down the screen key) - [Satellite].

To clear the satellite information screen, press the  key.

Memo

Split display is not allowed for a satellite information screen together with other screens.

6.6.1 Information that is displayed on the satellite information screen

The following information items are displayed on the satellite information screen.

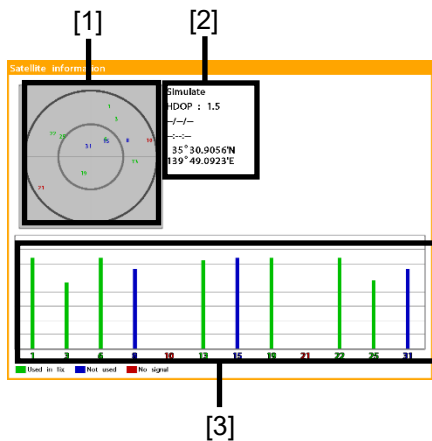

[1] PRN code

The PRN code of the GPS satellite that is currently used is displayed.

[2] Positioning status

A reception status, current date and time, and positioned position are displayed.

[3] Reception level

GPS satellite reception levels are displayed in a bar graph.

PRN codes and bar graphs are color coded as follows.

Green: Satellite that is used for positioning

Blue: Satellite that is not used for positioning

Red: Satellite from which received signals are not detected

6.6.1.1 Checking data received from a GPS receiver

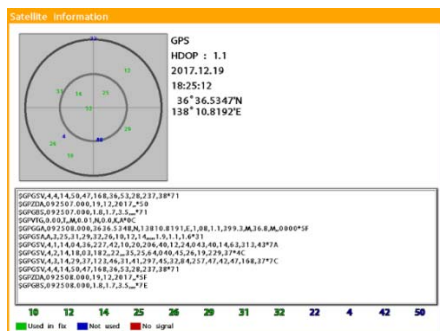

Received data can be monitored by pressing the (Center) or key.

6.7 Tide table screen

A tide table screen displays information such as the time of low tide and high tide, and tide level, as well as the time of sunrise/sunset and moon rise/moon set at the position closest to own ship or cursor position.

This function is displayed when new pec is selected.

Displays/clearing a tide table screen

1 Move the cursor to the position at which tide table is to be displayed on the map screen.

2 Operate in the order of (Hold down the screen key) – [Tides].

To clear the tide table screen, press the key.

Memo

Split display is not allowed for a tide table screen together with other screens.

6.7.1 Information displayed on a tide table screen

The following information items are displayed on a tide table screen.

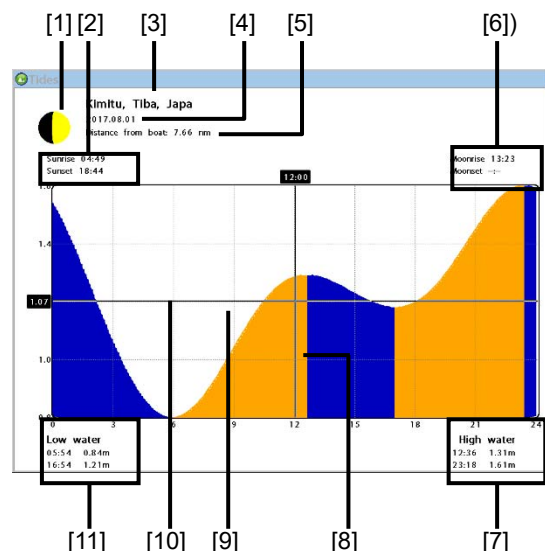



[1] Moon age chart

[2] Time of sunrise/sunset

[3] Position targeted for the tide table



- [4] Date of the tide table
- [5] Distance from own ship
- [6] Time of moon rise/moon set
- [7] Time and tide level of high tide
- [8] Time cursor
- [9] Tide graph
- [10] Tide level cursor
- [11] Time and tide level of low tide

6.7.1.1 Bringing a date forward/backward

When the  (Forward) key is pressed, the date is brought forward by one day.
 When the  (Backward) key is pressed, the date is brought backward by one day.

Memo
 A date can be changed by using the tide table screen menu.
 For the details, see Section 7.6 “Tide Table Screen Menu”.



6.7.1.2 Moving the time cursor/tide level cursor

When the  (Left/Right) key is pressed, the time cursor moves to the left/right.
 When the  (Up/Down) key is pressed, the tide level cursor moves to up/down.

6.8 AIS numeric information screen

AIS information of other ships is displayed on an AIS numeric information screen.
 Other ships that transmit AIS information through AIS (Automatic Identification System) are called AIS targets.

Displaying/clearing an AIS numeric value display screen

To display an AIS numeric value display screen, operate in the order of  (Hold down the screen key) – [AIS].
 To clear the AIS numeric value display screen, press the  key.

Memo
 Split display is not allowed for an AIS numeric value display screen together with other screens.

6.8.1 Information displayed on the AIS numeric value display screen

AIS target basic information is displayed in the list on the AIS numeric value display screen.

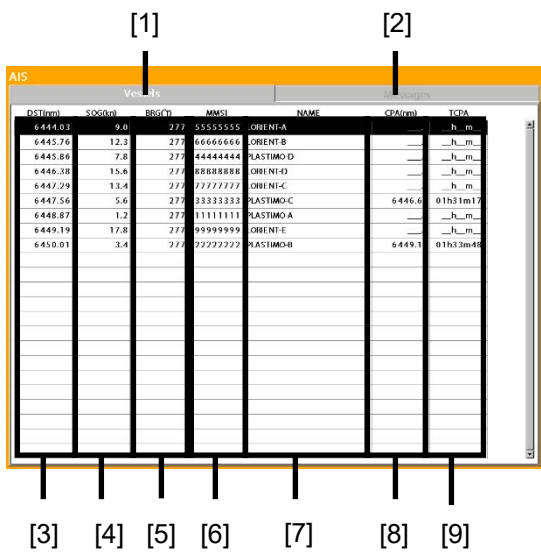

Vessels								
DST(m)	SOG(kn)	BOSG	MMSI	NAME	CPA(m)	TCPA		
6444.03	9.0	277	55555555	LORENZA				
6445.76	12.3	277	66666666	LORENTB				
6445.88	7.8	277	44444444	PLASTIMO-D				
6446.38	13.4	277	88888888	ORIENTA				
6447.29	13.4	277	77777777	ORIENT-C				
6447.56	5.6	277	33333333	PLASTIMO-C	6446.6	01h31m17		
6448.87	1.2	277	11111111	PLASTIMO-A				
6449.19	17.8	277	99999999	ORIENT-E				
6450.01	3.4	277	22222222	PLASTIMO-B	6449.1	01h33m48		

[1] [Vessels] tab

When AIS target information is received, the characters are displayed in reverse video.

[2] [Messages] tab

When a message is received from the AIS target, the characters are displayed in reverse video.

[3] DST(nm)

The distance from own ship to the AIS target is displayed.

[4] SOG(kn)

The speed of the AIS target is displayed.

[5] BRG(°T)

The bearing of the AIS target is displayed.

[6] MMSI

MMSI (identification number of the ship with the DSC communication equipment installed) of the target is displayed.

[7] NAME

The ship's name of the AIS target is displayed.

[8] CPA(nm)

The minimum approach distance from the AIS target is displayed.

[9] TCPA

The time to reach the closest point of approach distance from the AIS target is displayed.

6.8.1.1 Checking detailed information

Select a ship whose detailed information is to be checked by pressing the  (Up/Down) keys.

The following detailed information is displayed.

Vessel info:CAPE BRETT	
Position	033°41.007'N 132°05.865'E
Heading	102°T
ROT	0°/min
COG	102.8°T
SOG	14.0kn
BRG	258.2°T
DST	387.04nm



 To select 1/4

A detailed information screen comprises 4 pages in total.

Switch the page by using the  (Left/right) keys.

To clear the detailed information screen, press the  key.

The following procedure also can be used to check detailed information.

- 1 Select an AIS target by using the  (Up/Down) keys and press the  (Menu) key.

The following menu is displayed.

Options
Display
More Info
Sort by DST



- 2 Select [More Info] and confirm the selection.

6.8.1.2 Checking a received message

When an AIS message is received, the characters on the [Messages] screen are displayed in reverse video.

Switch to the [Messages] tab screen by pressing the  (Left) key.

6.8.1.3 Checking an AIS target position on the map on the map

- 1 Select an AIS target by pressing the  (Up/Down) keys and press the  (Menu) key.

The following menu is displayed.

Options
Display
More Info
Sort by DST

- 2 Select [Display] and confirm the selection.

The AIS numeric information screen is cleared and a map screen is displayed.

The AIS target that was selected in Step 1 is displayed at the center of the map.



6.8.1.4 Sorting AIS targets

- 1 Select AIS target by using the (Up/Down) keys and press the (Menu) key.

The following menu is displayed.



- 2 Select [Sort by] and confirm the selection.

A screen for selecting a sorting criterion is displayed.



- 3 Select a sorting criterion and confirm the selection.

6.9 DSB information screen

On a DSB information screen, information on other ships that was received through DSB radio equipment can be displayed.

Enter the TTM sentence from another ship with the DSB radio equipment of own ship.

Displaying/clearing a DSB information screen

To display a DSB information screen, operate in the order of (Hold down the screen key) – [DSB].

To clear the DSB information screen, press the key.

Memo

Split display is not allowed for a DSB information screen together with other screens.

6.9.1 Information displayed on a DSB information screen

The following information is displayed on a DSB information screen.

[1]	[2]	[3]	[4]	[5]	
ID	Lat	Lon	Spd (knt)	Dist (ktm)	Brng
01	35°28.654N	139°58.401E		1.40	224.3
02	35°27.857N	139°56.490E		3.12	234.1
03	35°27.822N	139°56.539E		3.11	233.2
04	35°27.841N	139°56.515N		3.11	233.7
05	35°27.821N	139°56.541E		3.11	233.2
06	35°26.056N	139°50.365E		8.35	244.2
07	35°26.570N	139°52.475N		6.61	241.4
08	35°28.619N	139°51.757E		6.47	240.5
09	35°28.748N	139°52.011E		6.25	261.3
10	35°26.741N	139°52.888E		6.21	241.7
11	35°27.471N	139°52.854E		5.92	248.0
12	35°27.270N	139°52.662E		6.14	246.8
13	35°28.713N	139°50.302E		7.63	262.6
14	35°28.914N	139°50.889E		7.13	263.8
15	35°28.805N	139°52.004E		6.25	261.9
16	35°27.702N	139°53.059E		5.68	249.5
17	35°28.549N	139°52.202E		6.15	259.2
18	35°27.965N	139°52.998E		5.84	252.2
19	35°26.932N	139°51.719E		6.98	246.8
20	35°26.766N	139°51.292E		7.37	246.6
21					
22					
23					

[1] ID number

[2] Latitude/longitude

[3] Speed

Blank space

[4] Distance



Distance from own ship

[5] Bearing

Bearing from own ship



6.9.1.1 Displaying other ship at the center of the map

By selecting any ship from other ships that are displayed on the DSB information screen, the position can be displayed at the center of the map.

- 1 **Select other Ship to be displayed by using the   (Up/Down) keys and press the  (Menu) key.**
The following menu is displayed.



[Display] is selected.

- 2 **Press the  (Center) or  (Right), or  key.**
The symbol of selected ship (blue diamond shape) is displayed at the center of the map.

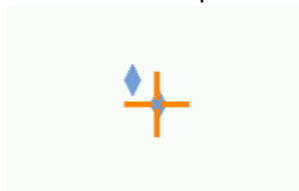

6.10 NAVTEX screen

The NAVTEX message that is received is displayed on the NAVTEX screen.

Displaying/clearing a NAVTEX screen

To display a NAVTEX screen, operate in the order of  (Hold down the screen key) - [Navtex].

To clear the NAVTEX screen, press the  key.

Memo

Split display is not allowed for a NAVTEX screen together with other screens.

6.10.1 Information displayed on a NAVTEX screen

The following information is displayed on a NAVTEX screen.



[1]	[2]	[3]
Time	Msg ID	Freq
00:00 2000.01.01	HL29	518kHz
00:00 2000.01.01	HL01	518kHz
00:00 2000.01.01	HA31	518kHz
00:00 2000.01.01	HA33	518kHz
00:00 2000.01.01	HL29	518kHz

[4]
1362 00510 UTC DEC 11 MISSING NO.296 ONE MAN FELL DOWN FROM CLIFF AT MITSUBISHI FUDOKAWA TOWNSHIP (2-29N 131-43E) AND WENT MISSING 0.0255MTC SHIPS IN THE VICINITY ARE REQUESTED TO KEEP A SHARP LOOKOUT AND REPORT ANY INFORMATION TO JAPAN COAST GUARD. NNNN

- [1] Reception time
- [2] Message ID
- [3] Reception frequency
- [4] Message text

6.10.1.1 Checking a message text on a large window

Only a message text can be displayed on almost the entire area of the screen.

- 1 Select a message to be displayed by pressing the   (Up/Down) keys and press the  (Menu) key. The following menu is displayed.



- 2 Select [View message] and confirm the selection. The message is displayed in a large window.

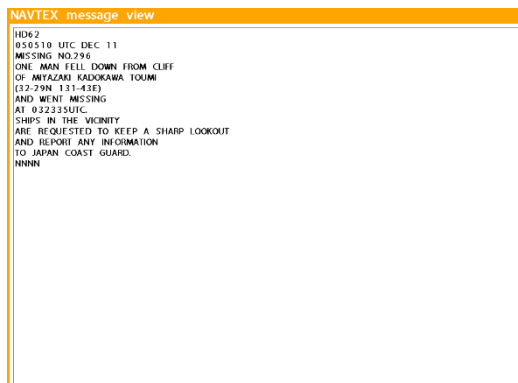

To clear the large window, press the  key.

6.10.1.2 Reloading messages

Update the NAVTEX screen to the latest receiving state.



- 1 Press the  (Menu) key. The following menu is displayed.



- 2 Select [Reload all] and confirm the selection.

- 3 Select [Yes] and confirm the selection.

6.10.1.3 Deleting a message

- 1 Select a message to be deleted by pressing the   (Up/Down) keys and press the  (Menu) key. The following menu is displayed.

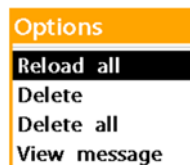

- 2 Select [Delete] and confirm the selection.
- 3 Select [Yes] and confirm the selection.

6.10.1.4 Deleting all the messages

- 1 Press the  (Menu) key. The following menu is displayed.

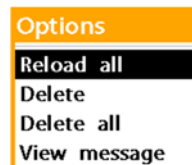

- 2 Select [Delete all] and confirm the selection.
- 3 Select [Yes] and confirm the selection.



Section 7 Function Menus

This section describes the setting values and contents of all the items of the function menu specific to each screen.













Memo

For the details of the menu operation procedure, see Section 4.4.2 “Operating the System Configuration menu/function menu”.

7

Notations of the operation procedure

In this Section, the menu operation procedures may be described by simplifying them according to the following notation standards.

No.	Notation	Operation contents	Example
1	Select	Display the item in reverse video by using the   (Up/Down) keys.	Select [New waypoint].
2	Confirm	Confirm the selected item by using the  (Center),  (Right), or  key (or  (Center) or  key).	Confirm [New waypoint].
3	Select and confirm	Consecutive operations of No.1 and No.2	Select and [New waypoint] confirm the selection.
4	Operate in the order of  (Menu) key - [Find] - [Routes]	Press the  (Menu) key, select [Find] and [Routes] consecutively from the menu that is displayed, and confirm the selection.	-
5	Enable	Attach a check mark by pressing the  (Center) or  key.	Enable [Data bar].
6	Disable	Remove a check mark by pressing the  (Center) or  key.	Disable [Data bar].

7.1 Map screen menu





Operations that are available on the map menu vary depending on the cursor position on the map screen.

Correspondingly, a number of map menu patterns are available.

Condition	Operations available under the condition	Example of map menu
The cursor is set at the position other than the mark.	<ul style="list-style-type: none"> Start route navigation to the cursor position. Set a new route. 	
The cursor is set on the mark.	<ul style="list-style-type: none"> Start route navigation by using the mark where the cursor is set as the destination. Edit, move, or delete the mark. 	
Route navigation is in progress	<ul style="list-style-type: none"> Skip the waypoint. End the route navigation. 	

The function of each item on the map screen menu is described below.

Item	Setting contents	Setting value (Underline: Default value)
Goto cursor	Start route navigation by using the own ship's position or the cursor position as the temporary destination. See Section 5.8.7 "Creating a temporary destination".	-
Goto WPT	Start temporary route navigation by using the own ship's position as the starting point and the mark to which the cursor is set as the destination.	-
Start route	Start route navigation by using the route that is et. See Section 5.9.1 "Starting route navigation".	-
Cancel route	End route navigation. See Section 5.9.3 "Ending route navigation".	-
Cancel goto	End route navigation to the temporary destination.	-
Reset XTE	Reset XTE from the current position.	-
New waypoint	Register a mark at the cursor position. See Section 5.7.1 "Registering a mark at the cursor position". For the details of the [Create waypoint] screen, see Section 7.1.1 "How to set the [Create waypoint] screen".	-
Skip	Skip the next waypoint and changes to the route towards the next waypoint during route navigation.	-
New route	Set a new route. See Section 5.8.1 "Setting a route directly on the map".	-
Edit	Edit a name and a shape of a mark. See Section 5.7.3.1 "Changing names positions, and shapes collectively".	-
Move	Move a position of a mark on the map. See Section 5.7.3.2 "Moving a mark".	-
Delete	Delete the mark that is registered. The mark that is currently used in the route cannot be deleted. See Section 5.7.4.1 "Deleting a mark by specifying it on the map".	-
Chart info	Display the screen that describes the meaning of the abbreviations and symbols that are used on the map of this equipment. To clear the screen, press the  key.	-

Item		Setting contents	Setting value (Underline: Default value)	
Distance		<p>Measure the distance and bearing from any reference point to any point on the map.</p> <p>Set the cursor to the reference point, press the  (Center) or  key, and move the cursor to any point by using the trackball or the  (Up/Down/Left/Right) keys.</p> <p>The distance and bearing from the reference point to the specified point are displayed at the bottom left corner of the screen.</p> <p>To end the operation, press the  key.</p>	-	
User line drawing		<p>Switch to a line drawing mode.</p> <p>See Section 5.6 “Drawing lines”.</p>	-	
User line display		<p>Set the graphics and characters that are created in plotting mode to display or undisplay.</p> <p>When a check mark is attached, the item is enabled (display) and when the check mark is removed, the item is disabled (undisplay).</p>	<u>Enable</u> Disable	
Find	Waypoints	<p>Search a mark that is registered.</p> <p>When a mark to be searched is selected from the mark list that is displayed and the selection is confirmed, the mark is displayed at the center of the map.</p>	-	
	Routes	<p>Search a route that is set.</p> <p>When a route to be searched is selected from the route list that is displayed and the selection is confirmed, the first waypoint of the route is displayed at the center of the map.</p>	-	
	AIS vessels	By MMSI	<p>Search other ship (AIS target) with its MMSI (identification number).</p> <p>When MMSI to be searched is selected from the MMSI list that is displayed and the selection is confirmed, the position of the AIS target is displayed at the center of the map.</p>	-
		By Name	<p>Search other ship (AIS target) with the name.</p> <p>When a name to be searched is selected from the name list that is displayed and the selection is confirmed, the position of the AIS target is displayed at the center of the map.</p>	-
	Ports by name		<p>Search a port.</p> <p>When a port name to be searched is selected from the port name list that is displayed and the selection is confirmed, the position of the port of the search target is displayed at the center of the map.</p> <p>To end the operation, press the  key.</p>	-
	Tide station		<p>Search a tide information forecast point.</p> <p>When a point to be searched from the point list that is displayed and the selection is confirmed, the search target point is displayed at the center of the map.</p>	-

Item		Setting contents	Setting value (Underline: Default value)
Data bar	Layout	Set the layout of own ship information. See Section 6.1.1.1 "Setting a data bar(layout)".	Off <u>Layout-1/2/3/4/5/6/7/8/9</u>
	Data bar	Set whether a data bar is to be displayed. When a check mark is attached, the item is enabled (display) and when the check mark is removed, the item is disabled (undisplay).	<u>Enable</u> Disable
	Data bar setup	Set the information to be displayed in the 12 display areas of the [type - 1] and [type - 2] data bars. See Section 6.1.1.2 "Setting a data bar".	-
	Data bar position	Set whether the data bar is to be displayed at the top or bottom of the screen.	Top <u>Bottom</u>
	Data bar mode	Select a pattern of the data bar to be displayed from [type - 1] to [type - 2] or [None]. For the details of the patterns, see Section 4.2.3 "Switching the Data bar pattern".	<u>type - 1</u> type - 2 None
	Background	Set a background color of a data bar.	<u>Black</u> White
	Data bar blank line display	Set Display or Undisplay for the line without information on the data bars of [type - 1] and [type - 2]. When a check mark is attached, the line is enabled (Display) and when the check mark is removed, the line is disabled (Undisplay).	Enable <u>Disable</u>
	Status bar	Set a status bar to Display or Undisplay. When a check mark is attached, the status bar is enabled (Display) and when the check mark is removed, the status bar is disabled (Undisplay).	<u>Enable</u> Disable
	Compass	Set a status bar to Display or Undisplay. When a check mark is attached, the status bar is enabled (Display) and when the check mark is removed, the status bar is disabled (Undisplay).	<u>Enable</u> Disable
	Compass (COG / SOG) set	Set whether ship's heading (HDG) or course over the ground (COG) is to be displayed at the center of the compass area.	COG <u>HDG</u>

7.1.1 How to set the [Create waypoint] screen

1 Display the [Create waypoint] screen.

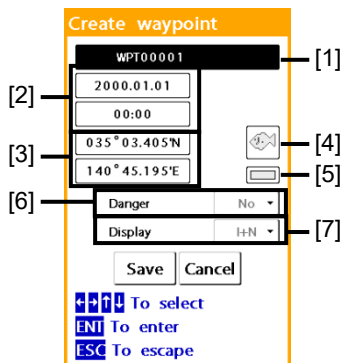

[1] Name of the mark

When this item is displayed, the following character setting screen is displayed.

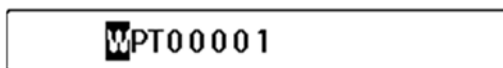

Select a character to be changed by using the (Left/Right) keys, change the character by using the (Up/Down) keys, and confirm the change by pressing the (Center) key or key.

Change the name to a required name by repeating this procedure and confirm the change by pressing the key.

[2] Date and time of mark registration

Change each digit that is blinking by using the keys and change the numeric value by using the keys.

[3] Latitude/longitude

Change each digit that is blinking by using the keys and change the numeric value by using the keys.

[4] Shape of the mark

Select a shape of the mark from the mark shape list.

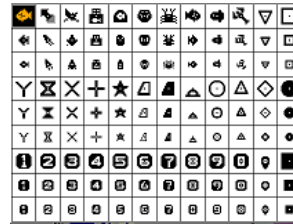

[5] Color of the mark

Select a color of the mark from 7 colors.

[6] Danger

Set a danger alarm.

Yes: An alarm is issued when own ship enters a danger alarm range.

When an alarm is issued, an alarm sound is emitted.

No: An alarm is not issued.

[7] Display

Select a mark display method when [Others] – [Waypoint] in the system configuration menu is set to [Selected].

OFF: Although the name and number of the mark are registered, the mark is not displayed on the map.

Icon: Only the icon of the mark is displayed.

I+N: The icon and name of the mark are displayed.

2 After the setting of the necessary items is completed, confirm the setting by selecting [Save].

The mark that is set is registered.

To cancel the registration, confirm the cancellation by selecting [Cancel].



7.2 Highway screen menu

Options
Data bar ▶

Item	Setting contents
Data bar	The contents are the same as those of [Data bar] in the map screen menu. See the “Data bar” item of Section 7.1 “Map screen menu”.



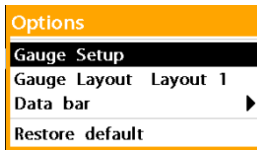







7.3 Data screen menu















Item		Setting contents	Setting value (Underline: Default value)
Gauge Setup	Data	Set display information of each gauge on the data screen. See Section 6.3.1.2 “Setting display information of each gauge”.	When the [Gauge layout] is any one of 1 to 3: 19 information items including Depth, Engine voltage, and Engine temp When the [Gauge layout] is any one of 4 to 6: 43 information items including Air temp, AIS status, and Bearing For the details, see Section 6.3.1 “Customizing a data screen”.
	Source	Set a source of the information that is selected in [Gauge value].	Port Starboard <u>All</u>
Gauge Layout		Switch a layout of the data screen. See Section 6.3.1 “Switching a data layout of a data screen”.	<u>Layout 1</u> Layout 2 Layout 3 Layout 4 Layout 5 Layout 6
Data bar		The contents are the same as those of [Data bar] in the map screen menu. See the “Data bar” item of Section 7.1 “Map screen menu”.	
Restore default		Reset all the settings in the data screen menu to the default values.	Yes <u>No</u>

7.4 Sonar screen menu

Options	
Window mode	No split
Frequency	200 KHz
Range	Manual
Gain	
A-scope	<input type="checkbox"/>
Interference filter	<input type="checkbox"/>
Noise filter	Off
Data bar	
Restore default	

Item	Setting contents	Setting value (Underline: Default value)
Window mode	<p>Split of a main screen is to split a sonar screen into the left and right, separate from the split of a main screen, and to display sonar information in different modes. When the mode is set to [Full screen] and [A – scope split], the image can be reset to the previous image by pressing the  (Left) key.</p> <p>Full screen: Not split into 2.</p> <p>Split zoom: A part of a normal sonar screen is expanded to the Top and Bottom direction and is displayed on the left side of the screen. Specify a section of a normal sonar screen to be expanded by using the   (Up/Down) keys and specify an expansion rate by using the   (Left/Right) keys.</p> <p>Full screen zoom: A part of a normal sonar screen is expanded without splitting it into 2. Specify a section of a normal sonar screen to be expanded by using the   (Up/Down) keys and specify an expansion rate by using the   (Left/Right).</p> <p>Split bottom: A sea bottom area of a normal screen is expanded and is displayed on the left side of the screen. Specify an expansion rate by using the   (Left/Right) keys.</p> <p>Split 50/200: Sonar information of 50kHz is displayed on the left side of the screen and sonar information of 200kHz is displayed on the right side of the screen.</p> <p>Split A-Scope: A normal sonar screen is displayed on the left side and an A-scope screen is displayed on the right side. The A-scope screen displays the strength of the sea clutter (echo) in the horizontal direction.</p>	<p><u>No split</u></p> <p>Split zoom</p> <p>Full screen zoom</p> <p>Split bottom</p> <p>Split 50/200</p> <p>Split A-scope</p>

Item	Setting contents	Setting value (Underline: Default value)	
Window split	Displayed when a mode other than [Full screen] and [Full screen zoom] is selected in [Screen mode]. Select [Window split] and move the boundary of the left and the right screens by using the   keys. The proportion occupied by the left screen to the entire screen can be adjusted within the range from 20% to 80% in the unit of 5%.	20 to <u>50</u> to 80%	
Frequency	Set a frequency of a transducer to be connected.	<u>200 KHz</u> 50 KHz	
Range	Select whether a depth is displayed automatically or manually. Auto: A sea bottom is always displayed on the screen. Manual: A depth can be changed by using the  (Zoom In)/  (Zoom Out) keys.	Manual <u>Auto</u>	
Gain	Mode	Select whether the gains of 200kHz and 50kHz are to be adjusted automatically or manually. Auto: The gains are adjusted automatically. Manual: The gains are adjusted manually.	<u>Auto</u> Manual
	200kHz 50kHz	Select [200kHz] and adjust the gain of 200kHz by using the   keys. Select [50kHz] and adjust the gain of 50kHz by using the   keys. Even if the [Mode] is set to Auto, the mode is switched to [Manual] by this operation.	0 to <u>10</u> to 20
	STC	Set whether a reaction of a shallow area around the sea surface is to be removed. When a check mark is attached, this item is enabled and when the check mark is removed, this item is disabled.	Enable <u>Disable</u>
	200kHz 50kHz	Adjustment is enabled when [STC] is enabled. Select [200kHz] and adjust STC of 200kHz by using the   keys. Select [50kHz] and adjust STC of 50kHz by using the   keys. The gains can be adjusted within the range from 0% to 75% in the unit of 5%.	0 to <u>20</u> to 75%
A-scope	Set whether A – Scope information is to be displayed on the right side of the sonar screen. When a check mark is attached, the item is enabled (Display) and when the check mark is removed, the item is disabled (Undisplay).	Enable <u>Disable</u>	
Bottom lock	Displayed when the [Screen mode] is [Split zoom] or [Full screen zoom]. Set whether a sea bottom is to be expanded for display following the undulation of a sea bottom. When a check mark is attached, this item is enabled (expand for display) and when the check mark is removed, this item is disabled (not expand for display).	Enable <u>Disable</u>	

Item	Setting contents	Setting value (Underline: Default value)
Interference filter	Set whether an interference filter is enabled when an interference wave from another ship enters in the image. When a check mark is attached, this item is enabled and when the check mark is removed, this item is disabled. .	Enable <u>Disable</u>
Noise filter	Set the strength of the function of the noise filter that removes noise from sonar information.	<u>Off</u> Medium High
Data bar	The contents are the same as those of [Data bar] in the map screen menu. See the "Data bar" item of Section 7.1 "Map screen menu".	
Restore default	Resets all the settings of the sonar screen menu to the default values.	Yes <u>No</u>



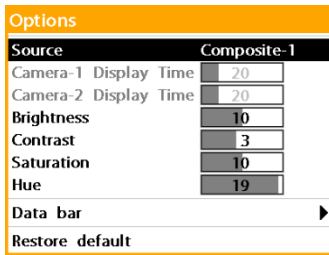



7.5 Video screen menu



Item	Setting contents	Setting value (Underline: Default value)
Source	Set an image signal to be input to this equipment. See Section 6.5.1.2 “Setting the equipment according to the input signal”.	<u>Composite-1</u> Composite-2 S-VIDEO Camera Scan
Camera-1 Display Time Camera-2 Display Time	Adjustments are enabled when two video units for outputting composite signals are connected and [Input] is set to [Camera scan]. Select [Camera-1 Display Time] and adjust the time (second) for displaying images of the first video unit (camera) by using the keys. Select [Camera-2 Display Time] and adjust the time (second) for displaying images of the second video unit (camera) by using the keys. The time can be adjusted within the range from 10 seconds to 60 seconds in the unit 10 seconds.	10 to <u>20</u> to 60 seconds
Brightness	Adjust a quality of the image that is displayed on a video screen. See Section 6.5.2 “Adjusting an image quality”.	0 to <u>10</u> to 20
Contrast		0 to <u>3</u> to 7
Saturation		0 to <u>10</u> to 20
Hue		0 to <u>19</u> to 20
Data bar	The contents are the same as those of [Data bar] in the map screen menu. See the “Data bar” item of Section 7.1 “Map screen menu”.	
Restore default	Reset all the settings on the video screen to the default values.	Yes <u>No</u>

7.6 Tide table screen menu

Options
Set date
Today
Next day
Prev day

Item	Setting contents	Setting value (Underline: Default value)
Set date	<p>Specify a date of the tide table.</p> <p>When [Set date] is selected and the selection is confirmed, the following date setting area is displayed in the top right corner of the screen.</p> <p></p> <p>Select a date by using the   keys and change the value by using the   key, and confirm the selection by using the  (Center) or  key.</p>	Jan(01)/01/2009 to Dec(12)/31/2099
Today	Displays today's information according to the calendar and clock that are set in the equipment.	-
Next day	Displays next day's information according to the calendar and clock that are set in the equipment.	-
Prev day	Displays previous day's information according to the calendar and clock that are set in the equipment.	-

7.7 AIS numeric value information screen menu

Options	
Display	
More Info	
Sort by	DST

Item		Setting contents	Setting value (Underline: Default value)
Display		Check an AIS target position on the map. See Section 6.8.1.3 “Checking an AIS target position on the map”.	-
More Info		Displays detailed information of an AIS target. See Section “6.8.1.1 Checking detailed information”.	-
Sort by	DST	Sort the AIS targets that are displayed on the [Vessels] tab in the AIS numeric value information screen menu. [DST]: Distance from own ship to the AIS target [SOG]: Speed of the AIS target [BRG]: Bearing of the AIS target [MMSI]: MMSI (identification number) of the AIS target [NAME]: Name of the AIS target [CPA]: Closest point of approach from the AIS target [TCPA]: Time to reach the closest point of approach from the AIS target	-
	SOG		
	BRG		
	MMSI		
	NAME		
	CPA		
	TCPA		

7.8 DSB information screen menu

Options
Display

Item	Setting contents	Setting value (Underline: Default value)
Display	Check the position of other ship that is displayed on the DSB information screen on the map. See Section 6.9.1.1 "Displaying other ship at the center of the map".	-

7.9 NAVTEX screen menu

Options
<u>Reload all</u>
Delete
Delete all
View message

Item	Setting contents	Setting value (Underline: Default value)
Reload all	Update the NAVTEX screen to the latest loading state.	-
Delete	Delete the NAVTEX message that is selected from the list.	-
Delete all	Delete all the NAVTEX messages that are being received.	-
View message	Display the text of the NAVTEX message that was selected from the list by using a large window.	-

Section 8 System Configuration Menus

This Section describes the setting contents and setting values of all the items of the system configuration menu of this equipment.

Memo

For the details of the menu operation procedure, see Section 4.4.2 “Operating the System Configuration menu/function menu”.

8

8.1 Setting general operation—System Configuration Menu

System Configuration	
Language	English
Chart	Navionics
Key Beep	On
Key light	Auto
Arrow key	Normal
Input time over	Off
Trackball	Normal
Data bar mode type	- 1
Units	▶
Factory Reset	▶
About	

Item	Setting Contents	Setting value (Underline: Default value)
Language	Select a display language.	<u>日本語</u> English
Chart	When both a new pec card and a Navionics card are inserted, switch to the chart to be displayed. When the chart is switched, this equipment restarts.	<u>Newpec</u> Navionics
Key Beep	Select whether to emit a beep sound when the key of the operation unit is pressed.	Off <u>On</u>





Item	Setting Contents	Setting value (Underline: Default value)
Key light	Select a brightness of the light of the key of the operation unit. Auto: Bright at the operation and becomes dark if no operation is performed for about 60 seconds. High: Increases the brightness. Low: Reduces the brightness.	<u>Auto</u> High Low
Arrow key	Select the operation on the chart screen when the Up/Down/Left/Right keys of the operation unit are pressed. Normal: The cursor (viewpoint) moves in the direction of the key that is pressed. Reverse: The chart moves in the direction of the key that is pressed.	<u>Normal</u> Reverse
Input time over	Set an input wait time at the operation of System Configuration menu. When not setting any wait time, set [Off].	<u>Off</u> 10 sec 20 sec 30 sec
Trackball	Select an amount of the display movement corresponding to the rotation of the trackball. The amount decreases in the order of Normal→Mid→Low.	Normal Mid Low
Data bar mode	Select a data bar pattern to be displayed from [type - 1], [type - 2] or [None]. For the patterns, see Section 4.2.3 "Switching a data pattern".	<u>type - 1</u> type - 2 None
Units	Distance	Set a unit of a distance. <u>nm</u> mi (mile) km
	Speed	Set a unit of a speed. <u>kn</u> mph (mile/hour) kph (km/hour)
	Depth	Set a unit of a depth. ft <u>m</u> fa (fathom)
	Fuel	Set a unit of a fuel. <u>Litres</u> USGal (US gallon) ImpGal (Imperial gallon)







Item		Setting Contents	Setting value (Underline: Default value)
Units	Compass	Set a reference of bearing.	<u>°T</u> °M
	Temperature	Set a unit of a water temperature.	°F <u>°C</u>
	Wind direction	Select a true wind direction or an apparent wind direction. App: Apparent wind direction True: True wind direction	<u>App</u> True
	Wind speed	Set a unit of a wind speed.	<u>kn</u> mph kph bft (Beaufort wind scale)
	Pressure	Set units of a water pressure and an oil pressure.	<u>kPa</u> psi
	Baro	Set a unit of a barometric pressure.	inHg mmHg <u>hPa</u>
Factory reset	Partial	Clears the system configuration only.	Yes <u>No</u>
	Full	Clears the system configuration and the user data and resets to the factory setting. Note: When [Full] is executed, user data such as Track & Log and marks is also cleared as well as the system configuration data.	Yes <u>No</u>
About		Displays the firmware version, chart data version, etc.	-

8.2 Setting display of own ship and so on—Own ship menu

Own ship	
Screen position	Center
Motion	True motion
Symbol type	Circle
Symbol size	Large
Symbol color	■
Symbol blink	Off
Own rings mode	Off
Own rings size	0.10 nm
Own rings value	1
Head vector	Short
COG vector	30 min
COG filter	Off
SOG filter	Off
1st. Position device	GPS
2nd. Position device	None
TCPA limit	10min
CPA limit	1.0 nm

Item	Setting Contents	Setting value (Underline: Default value)
Screen position	Select a display position of own ship on the screen when the  (Center) key is pressed. . [Bottom] can be set only at C-UP H-UP, or WP-UP display in Relative mode.	<u>Center</u> Bottom
Motion	Set a motion mode.	<u>True motion</u> Relative mode
Symbol type	Set an own ship symbol type. .	<u>Circle</u> Ship
Symbol size	Set an own ship symbol size.	Small Medium <u>Large</u>
Symbol color	Set an own ship symbol color.	16 colors available
Symbol blink	Set On/Off of blinking of an own ship symbol.	<u>Off</u> On
Own rings mode	Set whether to display a ring based on own ship as the center. When this item is set to [Off], a ring is not displayed.	<u>Off</u> Fix Scale

Item	Setting Contents	Setting value (Underline: Default value)
Own rings size	Set a size of the ring based on own ship as the center. <u>Setting a radius of the ring</u> Enter a value by using numeric keys or select a digit to be set by using the  (Left/Right) key, change the value by using the  (Up/Down) keys, and confirm the change by using the  (Center) or  key.	0.01 to <u>0.10</u> to 99.99 nm
Own rings value	Set the number of rings based on own ship as the center.	<u>1/2/3/4/5</u>
Head vector	Set a length of the heading vector.	Off <u>Short</u> Medium Long
COG vector	Set a vector length of the course over the ground. When time is selected, the length of the vector can be calculated from the ship speed.	Off/1 min/2 min/ 3 min/4 min/5 min/ 10 min/15 min/ 20 <u>min</u> /30 min/ 1 hour/2 hours/ Short/Medium/Long
COG filter	Averages with the time for which variations of the course over the ground are set.	<u>Off</u> /1/2/3/4/5/6/7/8/9/10
SOG filter	Averages with the time for which variations of the ship speeds are set.	<u>Off</u> /1/2/3/4/5/6/7/8/9/10
1st. Position device	Select a port for acquiring position data as the first priority.	GPS ANT <u>GPS</u> NMEA0183-1 NMEA0183-2 NMEA2000
2nd. Position device	Select a port for acquiring position data as the second priority.	GPS ANT GPS NMEA0183-1 NMEA0183-2 NMEA2000 <u>None</u>
TCPA limit	Set a limit value of TCPA (time to closest point of approach). When the time for any other ships to reach CPA (closest point of approach) becomes less than the limit value that is set here, a TCPA alert can be issued.	2 min/5 mim/10min/15min/2 0min/30min/1hour

Item	Setting Contents	Setting value (Underline: Default value)
DCPA limit	<p>Set a DCPA (closest point of approach) limit value. When any other ships approaches own ship closer than the limit value that is set here, a CPA alert can be issued.</p> <p><u>Setting a CPA limit value</u> Enter a value by using numeric keys or select a digit to be set by using the   (Left/Right) key, change the value by using the   (Up/Down) keys, and confirm the change by using the  (Center) or  key.</p>	0.1 nm to <u>1.0 nm</u> to 9.9 nm

8.3 Setting chart display–Chart menu

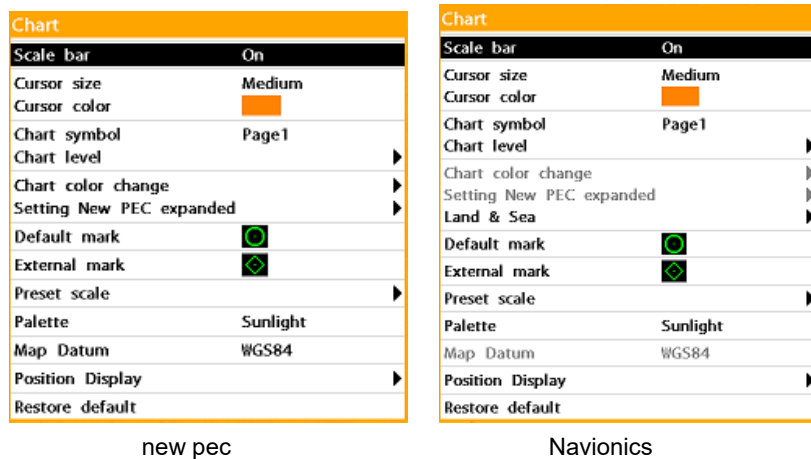





new pec

Navionics

Item	Setting Contents	Setting value (Underline: Default value)
Scale bar	Set whether to display a scale bar and the length.	Off <u>On</u>
Cursor size	Set a cursor size.	Small <u>Medium</u> Large
Cursor color	Set a cursor color.	16 colors available
Chart symbol	Select information to be displayed from 3 levels (Page1 to Page3).	<u>Page1</u> Page2 Page3
Chart level	<p>page1</p> <p>page2</p> <p>page3</p>	<p>Set display information of each chart level from Page1 to Page3. The information that can be displayed varies depending on new pec and Navionics.</p> <p>For the details of the chart level setting procedure, see Section 5.2.4.1 “Setting a chart level”.</p>
Chart color change (for new pec only)	<p>Sunlight</p> <p>Land color</p> <p>Coast line color</p> <p>River/Lake color</p> <p>Sea color</p> <p>Night</p> <p>Land color</p> <p>Coast line color</p> <p>River/Lake color</p> <p>Sea color</p>	<p><u>Standard</u></p> <p>16 colors</p>

Item		Setting Contents		Setting value (Underline: Default value)	
Setting New PEC expanded (for new pec only)	New PEC expanded	Set an outline submarine topography is to be displayed. When a check mark is attached, this item is enabled and when the check mark is removed, this item is disabled.		Enable <u>Disable</u>	
	Using New PEC expanded	Set the isobath pattern.		<u>Standard</u> Customized-1 to 5	
	Customized-1 to 5	Low depth	Set the range to display isobath. (Shallow side)		<u>1/11/21/31/51/101/201</u> m
		High depth	Set the range to display isobath. (Deep side)		10/20/30/50/100/ <u>200/200~</u> m
		Interval	Set the interval to display isobath.		1/5/10/20/50/100/ <u>200/500</u> m
		Setting isobath	1m 5m 10m 20m 50m 100m 200m 500m	Set the isobath color and line type.	Color: 16 colors Line type: Solid/One-dot chain/ two-dot chain/ Broken

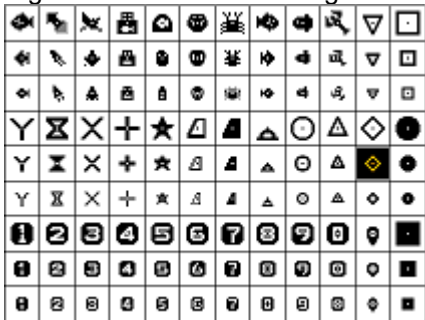
Item		Setting Contents	Setting value (Underline: Default value)
Land & Sea (At Navionics only)	Water features	Set whether to display water features. When a check mark is attached, this item is enabled (display) and when the check mark is removed, this item is disabled (undisplay).	<u>Enable</u> Disable
	Land features	Set whether to display land features. When a check mark is attached, this item is enabled (display) and when the check mark is removed, this item is disabled (undisplay).	<u>Enable</u> Disable
	Spot soundings	Set whether to display spot soundings.	<u>Enable</u> Disable
	Spot soundings	Spot soundings can be set within the range from 0 to 20000m in 1m units.	0 to <u>20000m</u>
	Safety depth	Set whether to display safety depth.	<u>Enable</u> Disable
	Safety depth	Safety depth can be set within the range from 1 to 20000m in 1m units.	1 to <u>10</u> to 20000m
	Depth contour	Set whether to display depth contour. When a check mark is attached, this item is enabled (display) and when the check mark is removed, this item is disabled (undisplay).	<u>Enable</u> Disable
	Depth contour	Set depth contour display range. Depth contour can be set within the range from 1m to 20000m in 1m units.	1 to <u>100</u> to 20000m
	Rocks filter	Set whether a rock filter is to be displayed.	Enable <u>Disable</u>
	Rocks filter	A rock filter can be set within the range from 1 to 20000m in 1m units.	1 to <u>300</u> to 20000m
	Shallow area	A shallow area can be set within the range from 1 to 100m in 1m units.	<u>0</u> to 100m
	Fishing range minimum	A minimum fishing range can be set within the range from 1 to 10000m in 1m units.	<u>0</u> to 10000m
	Fishing range maximum	A maximum fishing range can be set within the range from 1 to 10000m in 1m units.	<u>0</u> to 10000m
	Canal	Set whether to display a canal.	<u>Enable</u> Disable

Item		Setting Contents	Setting value (Underline: Default value)
Land & Sea (At Navionics only)	Port object	Set whether to display a port object.	<u>Enable</u> Disable
	Colored seabed	Set whether to display a colored seabed. When a check mark is attached, this item is enabled (display) and when the check mark is removed, this item is disabled (undisplay).	<u>Enable</u> Disable
	Dynamic tide & current	Set whether to display current and ocean time. When a check mark is attached, this item is enabled (display) and when the check mark is removed, this item is disabled (undisplay).	Enable <u>Disable</u>
Default mark		Hold down the  (Mark) key and select a shape of the mark to be registered at the own ship's position from the following: 	<Default value> 
External mark		Press the external event switch and select a shape of the mark to be registered from the following: 	<Default value> 

Item		Setting Contents	Setting value (Underline: Default value)	
Preset scale	Preset scale1 Preset scale10	Preset 10 scale values (lengths of the scale bars) from Preset scale1 to scale 10. For the details of the preset procedure, see Section 5.2.2 "Presetting scale values".	Off/0.01/0.05/0.1/ 0.2/0.5/1.0/2.0/ 3.0/5.0/10.0/ 20.0/50.0/100.0/200.0/300.0 <Default value> Preset scale1: <u>0.01</u> Preset scale2: <u>0.05</u> Preset scale3: <u>0.1</u> Preset scale4: <u>0.2</u> Preset scale5: <u>0.5</u> Preset scale6: <u>1.0</u> Preset scale7: <u>2.0</u> Preset scale8: <u>3.0</u> Preset scale9: <u>5.0</u> Preset scale10: <u>10.0</u>	
Palette		Set brightness of the screen when the power supply of this equipment is turned on.	<u>Sunlight</u> Night	
Map Datum		Select a map datum to be used.	216 types including <u>WGS84</u> (NAVIONICS is WGS84 only)	
Position Display	LAT/LON display	Set which of the latitude/longitude, LORAN-C, LORAN-A, and DECCA is used as the current position for displaying information from GPS.	<u>GPS</u> LORAN-C LORAN-A DECCA	
	LORAN-C	Chain	Select GRI of the master station (Chain).	0000 to <u>5970</u> to 9999
		TD1	Set ID of slave station 1.	<u>00</u> to 99
		TD2	Set ID of slave station 2.	<u>00</u> to 99
		TD1 Correction	Set a transmission delay time of slave station 1 (unit μs).	-9.9 to <u>+0.0</u> to +9.9
		TD2 Correction	Set a transmission delay time of slave station 2 (unit μs).	-9.9 to <u>+0.0</u> to +9.9

Item		Setting Contents	Setting value (Underline: Default value)	
Position Display	LORAN -A	LOP1	Select a master station.	<u>1S1</u> to 9S9
		LOP2	Select a slave station.	<u>1S1</u> to 9S9
		TD1 Correction	Set a transmission delay time of a master station (unit μ s).	-9.9 to <u>+0.0</u> to +9.9
		TD2 Correction	Set a transmission delay time of a slave station (unit μ s).	-9.9 to <u>+0.0</u> to +9.9
	DECCA	Chain	Select a master station (Chain). <Alphabet and numeric digit conversion table> A B C D E F G H I J 0 1 2 3 4 5 6 7 8 9	<u>00</u> to 99
		LOP1	Set LOP of slave station 1.	<u>0A00.00</u> to 9A99.99
		LOP2	Set LOP of slave station 2.	<u>0A00.00</u> to 9A99.99
		LOP1 Correction	Set a delay time of LOP1.	-9.99 to <u>+0.00</u> to +9.99
		LOP2 Correction	Set a delay time of LOP2.	-9.99 to <u>+0.00</u> to +9.99
	Restore default		Reset all the settings relating to the map display to the default values. Select [Yes] to reset. Select [No] to cancel reset.	Yes <u>No</u>

8.4 Setting a sonar screen–Sonar menu

Sonar	
Frequency	200 KHz
Palette	White
Scroll speed	Fast
Digit size	Medium
Interference filter	<input type="checkbox"/>
Noise filter	Off
Pulse length	Medium
Pulse power	Medium
Color erase	Off
Transmission	1 KW
Restore default	

Item	Setting Contents	Setting value (Underline: Default value)
Frequency	Set a sounding frequency. 200KHz: Specify this when accuracy is emphasized. 50KHz: If this is specified, deep-water sounding is enabled, but the accuracy deteriorates.	<u>200 KHz</u> 50 KHz
Palette	Set a background color to be used on the sonar screen.	Black Blue <u>White</u> 8 colors
Scroll speed	Set a speed of sending images. When [Pause] is set, the depth value from the external serial port is displayed.	Very fast Fast Medium Slow <u>Pause</u>
Digit size	Set a size of the digit that indicates the depth at the top left corner of the sonar screen. When [Off] is selected, the depth display is set to Off.	Off Small <u>Medium</u> Large
Interference filter	Set whether to enable an interference filter when interference waves from other ships enter in the image. When a check mark is attached, this item is enabled and when the check mark is removed, this item is disabled.	Enable <u>Disable</u>
Noise filter	Set the strength of the noise filter that removes noise from the sonar information.	<u>Off</u> Medium High







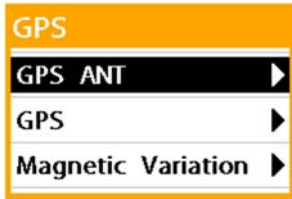

Item	Setting Contents	Setting value (Underline: Default value)
Pulse length	Image signals can be changed by changing the image resolution. If [Short] is selected, the resolution increases, however, the power decreases. If [Long] is selected, the resolution decreases, however the power increases.	Auto Short <u>Medium</u> Long
Pulse power	Change this setting when the image sensitivity is too high or too low. When [Auto] is set, the output changes according to the sounding range.	Auto Low <u>Medium</u> High
Color erase	Set an intensity of the function that erases signals of weak response from the image.	<u>Off</u> Low Medium High
Transmission	Displays the transmission power that is set.*1	<u>600W</u> 1KW
Restore default	Resets all the settings relating to the sonar screen to the default values. Select [Yes] to reset. Select [No] to cancel reset.	<u>No</u> Yes

*1: To change transmission power, the installation setting needs to be changed.

8.5 Setting GPS–GPS menu



Item		Setting Contents	Setting value (Underline: Default value)
GPS ANT	DGPS source	Set whether SBAS position fixing is applied to the GPS antenna.	None <u>SBAS</u>
GPS	Initialize GPS	Date	Set a date in the GPS receiver. 00.01.01 to 99.12.31
		Time	Set a time in the GPS receiver. 00.00 to 23.59
		Position(LAT)	Set an own ship's position (latitude) in the GPS receiver. -
		Position(LON)	Set an own ship's position (longitude) in the GPS receiver. -
		ANT height	Set an antenna height in the GPS receiver. -1000 to <u>+0005</u> to +9999
		Fix mode	Set a position fixing mode in the GPS receiver. 2D 3D Auto
		DOP level	Set a DOP level in the GPS receiver. Under 4 <u>Under 10</u> Under 20
		POS average	Set a position averaging value in the GPS receiver. <u>002</u> to 999
		Set data	This item is executed after Initialize GPS is changed. When this item is executed, the set command is transmitted to the GPS receiver. -

Item		Setting Contents	Setting value (Underline: Default value)	
GPS	Set DGPS	Mode	Set a frequency baud rate of the beacon automatically or manually.	Auto Manual
		Frequency	Set a frequency when [Mode] is set to [Manual].	280.0KHz to <u>310.0</u> to 330.0KHz
		Baud rate	Set a baud rate when [Mode] is set to [Manual].	50 bps 100 bps <u>200 bps</u>
		Correction mode	Set a DGPS correction mode.	Beacon SBAS Auto
		Set data	This item is executed when DGPS is changed. When this item is executed, the set command is transmitted to the DGPS receiver.	-
Magnetic Variation	Enabled	Set whether to enable the variation of the magnetic bearing. When a check mark is attached, this item is enabled and when the check mark is removed, this item is disabled.	Enable <u>Disable</u>	
	Value	Set a variation amount. <u>Setting a variation amount:</u> Select a digit to be set by using the   (Left/Right) keys, change the value by using the   (Up/Down) keys, and confirm the change by using the  (Center) or  key. To switch between 'W' and 'E, press the  (Zoom In)/  (Zoom Out) keys.	99.9'W to <u>00.0'E</u> to 99.9'E	

8.6 Setting tracks and logs–Track & Log menu

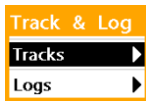

Item		Setting Contents	Setting value (Underline: Default value)
Tracks	Display		<p>The contents of the [Tracks] item are the same as the contents of the [Track & Log] menu that are displayed by holding down the  (Track & Log) key.</p> <p>For the contents, setting procedure, and default value of each item, see Section 5.5 “Setting the details of Track & Log display”.</p>
	Partial display		
	Track source		
	Data	Depth	
		Temperature	
		Current	
		Date	
		Time	
	Temperature	Temperature1 Temperature7	
	Depth	Depth1 Depth7	
	Current	Layer-A Layer-E	
	Maximum current		
	Old track display		
	Old track date		
	ARPA(TT) track save		
	ARPA track display		
	ARPA track delete		
	Thickness		
	Time		
	Delete track	All	
Date			
Color			

Item		Setting Contents	Setting value (Underline: Default value)
Logs	Reset trip dist	Resets the records of the trip distances up to the current point. To reset, select [Yes]. To cancel reset, select [No].	<u>No</u> Yes
	Reset total dist	Resets the record of the total distance up to the current point. To reset, select [Yes]. To cancel reset, select [No].	<u>No</u> Yes

8.7 Setting communication–Comms menu

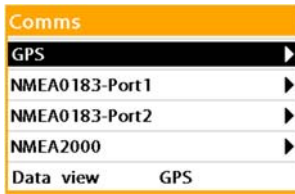









Item		Setting Contents	Setting value (Underline: Default value)
GPS	GPS / etc.	Set according to the equipment that is connected to the GPS port. GPS: Connects a GPS receiver or a GPS antenna. ETC: Inputs general-purpose NMEA signals.	<u>GPS</u> ETC
	NMEA/ JRC	When inputting general-purpose NMEA signals to the GPS port, select a format of the signal.	<u>NMEA</u> JRC
	NMEA0183 speed	When inputting general-purpose NMEA signals to the GPS port, select an input speed (Baud rate) of the signal.	<u>4800</u> 38400
NMEA0183 -Port1	NMEA / JRC	Select a format of the signals that are transmitted and received.	<u>NMEA</u> JRC
	NMEA0183 out	Select a data output interval. To suppress output of signals from the NMEA port 1, select [Off].	Off/ <u>1sec</u> /2sec/3sec/4sec/5sec
	NMEA0183 speed	Select an output speed (Baud rate) from NMEA0183 port 1.	<u>4800</u> 38400
	NMEA out version	Select a version of the sentence that is output from NMEA0183 port 1.	Version 1.5 Version 2.1 Version 2.3 <u>Version 4.0</u>
	NMEA0183 data	Select a sentence that is output from NMEA0183 port 1. The following sentences are available for setting. APA/APB/BWR/GGA/GLL/GSA/GSV/RMB/RMC/VTG/XTE/DBT/DPT/VHW/MTW/ZDA/HDT When a check mark is attached, this item is enabled and when the check mark is removed, this item is disabled.	<Default value> The following sentences are enabled. GGA/RMC/VTG

Item		Setting Contents	Setting value (Underline: Default value)
NMEA0183 -Port2	NMEA / JRC	Select a format of the signals that are transmitted and received.	<u>NMEA</u> JRC
	NMEA0183 out	Select a data output interval. To suppress output of signals from the NMEA port 2, select [Off].	<u>Off</u> /1sec/2sec/ 3sec/4sec/5sec
	NMEA0183 speed	Select an output speed (Baud rate) from NMEA0183 port 2.	<u>4800</u> 38400
	NMEA out version	Select a version of the sentence that is output from NMEA0183 port 2.	Version 1.5 Version 2.1 Version 2.3 <u>Version 4.0</u>
	NMEA0183 data	Select a sentence that is output from NMEA0183 port 2. Set for the following sentences. APA/APB/BWR/GGA/GLL/GSA/GSV/RMB/RMC/ VTG/XTE/DBT/DPT/VHW/MTW/ZDA/HDT When a check mark is attached, this item is enabled and when the check mark is removed, this item is disabled.	<Default value> Disable all
NMEA2000	NMEA2000 out	Set whether data is output from the NMEA2000 port. . When a check mark is attached, this item is enabled and when the check mark is removed, this item is disabled.	Enable <u>Disable</u>
	NMEA2000 PGN	Select PGN that is output from NMEA2000. The following PGN are available for setting. Water Speed (128259) / Water depth (128267) / XTE (129283) / NAV. data (129284) / NAV. data (129285) / COG & SOG (129026) / GNSS position (129029) / Water temp. (130310) When a check mark is attached, this item is enabled and when the check mark is removed, this item is disabled.	<Default value> Disable all
	Power	Set whether power is output from the NMEA2000 port. When a check mark is attached, this item is enabled and when the check mark is removed, this item is disabled.	Enable <u>Disable</u>
Data view		Displays the data that is received from the selected port.	<u>GPS</u> NMEA0183-1 NMEA0183-2 NMEA2000

8.8 Setting AIS information–AIS menu



Item	Setting Contents	Setting value (Underline: Default value)
Filter by type	Select a type of the AIS target to be displayed. The following types are available for setting. Cargo/Tanker/Passenger/Tug/Hi-speed/Fishing/Other When a check mark is attached, this item is enabled (display) and when the check mark is removed, this item is disabled (undisplay).	Enable all
Display filter	Select target information to be displayed when the AIS target is activated. To activate an AIS target manually, set the cursor to the AIS target symbol and press the  key. Display example of the activated AIS target:  The following information items can be set. Name/Speed/Course/Waypoints/Type When a check mark is attached, this item is enabled (display) and when the check mark is removed, this item is disabled (undisplay).	<Default value> Disable all
Trail	Select, with the number of points, the tack for which a line is to be drawn.	5dot/10dot/20dot/ <u>30dot</u> /50dot/Full
Color normal	Select a color of the AIS target in a normal state.	16 colors are available for setting.
Color danger	Select a color of the AIS target in a danger state.	16 colors are available for setting.

Item	Setting Contents	Setting value (Underline: Default value)
Track interval	Set a time interval for recording tracks.	<u>Off</u> / 5 sec/ 10 sec/ 15 sec/ 20 sec/ 30 sec/ 1 min/ 2 min/ 3 min/ 4 min/ 5 min/ 10 min/ 15 min/ 20 min/ 30 min/ 60 min
Active circle	<p>Set a range for automatically activating the AIS target. Set a circle based on own ship at the center. When an AIS target enters in the circle, the symbol is activated and displayed.</p> <p><u>Setting a radius of the range</u> Select a digit to be set by using the   (Left/Right) keys, change the value by using the   (Up/Down) keys, and confirm the change by using the  (Center) or  key.</p>	0.01 to <u>0.10</u> to 9.99nm
Lost time	Set a time required to identify the AIS target to be in a lost state.	30 sec/ 1 min/ 2 min/ 3 min/ 4 min/ <u>5 min</u> / 6 min/ 7 min/ 8 min/ 9 min/ 10 min/ 15 min/ 20 min/ 30 min/ 60 min
Delete time	Set a time from identifying of an AIS target to be in a lost state to clearing of the display.	30 sec/ 1 min/ 2 min/ 3 min/ 4 min/ 5 min/ 6 min/ 7 min/ 8 min/ 9 min/ <u>10 min</u> / 15 min/ 20 min/30 min/ 60 min
Special target	<p>Set any AIS target as a special target. A specific display method can be set to a special target individually. Specify an AIS target as a special target with the MMSI (Marine Mobile Service Identify). For the operation procedure, see Section 8.8.1 "Setting a special target".</p>	-
Restore default	<p>Reset AIS information. To reset, select [Yes]. To cancel reset, select [No].</p>	<u>No</u> Yes

8.8.1 Setting a special target

Memo

Specify an AIS target that is set as a special target with the MMSI.

MMSI comprises 9 digits and “*” (asterisk) can be used as a wild card.

The first 3 digits of MMSI indicate a country code and the country code of Japan is “431”.

Therefore, all the ships of Japanese nationality can be set to AIS targets by specifying “431*****”.

In the following procedure, only the ships of Japanese nationality are set as AIS targets by entering “431*****”.

- 1 Select  (Hold down the menu key) – [AIS] and confirm the selection.



An [AIS] menu is displayed.

- 2 Select [Special target] and confirm the selection.

A special target list is displayed.

No.	MMSI	Color	Safe	Active
01	431000000	Black	<input checked="" type="checkbox"/>	<input checked="" type="checkbox"/>
02	431001992	Red	<input checked="" type="checkbox"/>	<input checked="" type="checkbox"/>
03	400000000	Blue	<input checked="" type="checkbox"/>	<input checked="" type="checkbox"/>
04				
05				
06				
07				
08				
09				
10				
11				
12				
13				
14				
15				
16				
17				
18				
19				
20				
21				
22				
23				
24				





- 3 Select the [MMSI] blank column by using the   (Up/Down) keys.

- 4 Confirm the selection by pressing the  (Center) or  key.

A screen for specifying MMSI is displayed.



- 5 Enter MMSI of the AIS target to be set as a special target.

Select a numeric digit, “*” asterisk, or   by using the   (Left/Right) keys, and press the  (Center) key. Enter 9 digits of MMSI by repeating this procedure.



Here, enter “431*****”.





- 6 Confirm the setting by pressing the  key.

Return to the special target list.

- 7 Set a display color of the special target.

Select any color from the color list that is displayed by pressing the  (Center) or  key in the “Color” column and confirm the selection.



- 8 Set a danger target.

Attach (remove) a check mark by pressing the  (Center) or  key in the “Safe” column.

With check mark: When a special target enters into a danger area, the target is identified as a danger target.

Without check mark: When a special target enters into a danger area, the target is not identified as a danger target.



- 9 Set activation.







Attach (remove) a check mark by pressing the  (Center) or  key in the “Active” column.

When a check mark is attached, the special target is displayed always in the active state.

- 10 End the setting by pressing  key.

8.9 Setting ARPA(TT)–ARPA(TT) menu







ARPA(TT)	
Trail	Full
Color normal	
Color danger	
Track interval	Off
Active circle	0.10 nm
Lost time	5 min
Delete time	10 min

Item	Setting Contents	Setting value (Underline: Default value)
Trail	Select, with the number of points, a Track & Log for which a line is to be drawn.	5dot/10dot/20dot/ 30dot/50dot/ <u>Full</u>
Color normal	Select a color of the symbol that indicates a target tracking target in a normal state. See below for a display example of the symbol that indicates a target tracking target. 	16 colors are available for setting.
Color danger	Select a color of the symbol that indicates a target tracking target in a danger state.	16 colors are available for setting.
Track interval	Set a time interval for storing Track & Log of the target tracking target.	<u>Off</u> /5 sec/10 sec/ 15 sec/20 sec/ 30 sec/1 min/2 min/ 3 min/4 min/5 min/ 10 min/15 min/ 20 min/30 min/ 60 min
Active circle	Set a range for automatically activating a target tracking symbol. Set a circle based on own ship as the center. When a target tracking target enters into the circle, the symbol is displayed in the activated state. <u>Setting a radius of the circle</u> Select a digit to be set by using the   (Left/Right) keys, change the value by using the   (Up/Down) keys, and confirm the change by using the  (Center) or  key.	0.01 to <u>0.10</u> to 9.99nm
Lost time	Set a time required to identify the target tracking target to be in a lost state.	30 sec/1 min/2 min/ 3 min/4 min/ <u>5 min</u> / 6 min/7 min/8 min/ 9 min/10 min/15 min/ 20 min/30 min/ 60 min

Item	Setting Contents	Setting value (Underline: Default value)
Delete time	Set a time from the time when a target tracking target is set to a lost state to the time when the display is cleared.	30 sec/1 min/2 min/ 3 min/4 min/5 min/ 6 min/7 min/8 min/ 9 min/ <u>10 min</u> /15 min/ 20 min/30 min/ 60 min



8.10 Setting DSB-DSB(TT) menu

DSB(TT)	
Trail	Full
Color normal	
Track interval	Off
Active circle	0.10 nm
Lost time	5 min
Delete time	10 min

Item	Setting Contents	Setting value (Underline: Default value)
Trail	Select, with the number of points, a Track & Log for which a line is to be drawn.	5dot/10dot/20dot/ 30dot/50dot/ <u>Full</u>
Color normal	Set a color that indicates a DSB target. See below for an example of the symbol that indicates a DSB target. 	16 colors are available for setting.
Track interval	Set a time interval for storing Track & Log of DSB.	<u>Off</u> / 5 sec/ 10 sec/ 15 sec/20 sec/30 sec/ 1 min/ 2 min/ 3 min/ 4 min/ 5 min/ 10 min/ 15 min/ 20 min/ 30 min/ 60 min
Active circle	Set a range for automatically activating a DSB target. Set a circle based on own ship as the center. When a DSB target enters into the circle, the symbol is displayed in the activated state. <u>Setting a radius of the circle</u> Select a digit to be set by using the   (Left/Right) keys, change the value by using the   (Up/Down) keys, and confirm the change by using the  (Center) or  key.	0.01 to <u>0.10</u> to 9.99nm
Lost time	Set a time required to identify the DSB target to be in a lost state.	30 sec/1 min/2 min/ 3 min/4min/ <u>5 min</u> / 6 min/7 min/8 min/ 9 min/10 min/15 min/ 20 min/30 min/60 min
Delete time	Set a time from the time when a DSB target is set to a lost state to the time when the display is cleared.	30 sec/1 min/2 min/ 3 min/4 min/5 min/6 min/7 min/8 min/ 9 min/ <u>10 min</u> /15 min/ 20 min/30 min/60 min

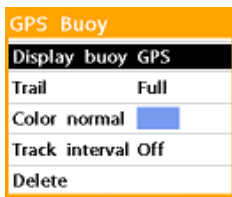
8.11 Setting GPS buoy–GPS Buoy menu























Item	Setting Contents	Setting value (Underline: Default value)
Display buoy	Set whether to display GPS buoy or satellite buoy(TLL). When inputting both the satellite buoy(TLL) and the external mark(TLL), the input port is fixed. Terminal block TB1: Satellite buoy(TLL) Terminal block TB2: External mark(TLL)	<u>GPS</u> /TLL
Trail	Select, with the number of points, a track for which a line is to be drawn.	5dot/10dot/20dot/ <u>30dot/50dot/Full</u>
Color normal	Set a color of the symbol that indicates GPS buoy. See below for a display example of the symbol that indicates GPS buoy. 	16 colors are available for setting.
Track interval	Set a time interval for storing a track of GPS buoy.	<u>Off</u> /5 sec/10 sec/ 15 sec/20 sec/ 30 sec/1 min/2 min/ 3 min/4 min/5 min/ 10 min/15 min/ 20 min/30 min/ 60 min
Delete	The latest information of GPS buoy is displayed. <u>Deleting information of GPS buoy from the list</u> To delete any of the information, initially select the information to be deleted. Press the  (Menu) key. The following screen is displayed.  To delete one of the information items, select [Delete] and to delete all the information items, select [Delete all] and confirm the selection. To delete, select [Yes] to confirm the selection.	-







8.12 Setting alarms–Alarms menu



Item		Setting Contents	Setting value (Underline: Default value)
Deep	Enabled	Set On or Off for the alarm at detection of a depth equal to or higher than the value that is set in [Value]. When a check mark is attached, this item is enabled and when the check mark is removed, this item is disabled.	<u>Enable</u> Disable
	Value	Set a depth that triggers a deep sea alarm. <u>Setting a depth</u> Select a digit to be set by using the (Left/Right) keys, change the value by using the (Up/Down) keys, and confirm the change by using the (Center) or key.	0m to <u>100m</u> to 379m
Shallow	Enabled	Set On or Off for the alarm at detection of a depth equal to or lower than the value that is set in [Value]. When a check mark is attached, this item is enabled and when the check mark is removed, this item is disabled.	Enable <u>Disable</u>
	Value	Set a depth that triggers a shallow alarm. <u>Setting a depth</u> Select a digit to be set by using the (Left/Right) keys, change the value by using the (Up/Down) keys, and confirm the change by using the (Center) or key.	0m to <u>10m</u> to 379m

Item		Setting Contents	Setting value (Underline: Default value)
Temperature	Enabled	Set On or Off of an alarm at detection of the water temperature equal to or higher than the value that is set in [value]. When a check mark is attached, this item is enabled and when the check mark is removed, this item is disabled.	Enable <u>Disable</u>
	Value	Set a temperature that targets a water temperature alarm. <u>Setting a temperature</u> Select a digit to be set by using the  (Left/Right) keys, change the value by using the  (Up/Down) keys, and confirm the change by using the  (Center) or  key.	0.0°C to <u>10.0</u> °C to 99.9°C
	Temperature mode	Set a condition for triggering a water temperature alarm. Below: When the temperature drops below the temperature that is set in "Value", an alarm is issued. Above: When the temperature rises above the temperature that is set in "Value", an alarm is issued.	<u>Below</u> Above
Low battery	Enabled	Set On or Off of the alarm when the voltage that is input in the processing unit drops below the value that is set in "Value". When a check mark is attached, this item is enabled and when the check mark is removed, this item is disabled.	<u>Enable</u> Disable
	Value	Set On or Off of the alarm when the voltage that is input in the processing unit drops below the value that is set in "Value". <u>Setting a voltage</u> Select a digit to be set by using the  (Left/Right) keys, change the value by using the  (Up/Down) keys, and confirm the change by using the  (Center) or  key.	<u>9.5V</u> to 30.0V













Item		Setting Contents		Setting value (Underline: Default value)
Navigation alarms	Waypoint alarm	Enabled	<p>Set if an alarm is to be issued when own ship enters in or deviates from the arrival circle range during route navigation.</p> <p>Off: An alarm is not issued. Arrival: An alarm is issued when own ship enters in the arrival circle range. Deviation: An alarm is issued when own ship deviates from the arrival circle range.</p>	<u>Off</u> Arrival Deviation
		Value	<p>Set a radius of the arrival circle when [Operation] is set to [Arrival] or [Deviation].</p> <p><u>Setting a radius</u> Select a digit to be set by using the   (Left/Right) keys, change the value by using the   (Up/Down) keys, and confirm the change by using the  (Center) or  key.</p>	0.01nm to <u>0.05nm</u> to 9.99nm
	Anchor alarm	Enabled	<p>Set if an alarm is to be issued when a circle monitoring area is set around own ship and own ship exits from the monitoring area.</p> <p>When a check mark is attached, this item is enabled and when the check mark is removed, this item is disabled.</p>	<u>Disable</u> Enable
		Value	<p>Set a radius of the monitoring area when [Operation] is enabled.</p> <p><u>Setting a radius</u> Select a digit to be set by using the   (Left/Right) keys, change the value by using the   (Up/Down) keys, and confirm the change by using the  (Center) or  key.</p>	0.00nm to <u>0.02nm</u> to 9.99nm
	XTE alarm	Enabled	<p>Set whether to issue an alarm when own ship enters in or deviates from the route width during route navigation.</p> <p>Off: An alarm is not issued. Deviation: An alarm is issued when own ship deviates from the route width. Entry: An alarm is issued when own ship enters in the route width.</p>	<u>Off</u> Deviation Entry







Item		Setting Contents	Setting value (Underline: Default value)
Navigation alarms		Value	Set a route width. 0.01/0.02/0.03/0.04/ 0.05/0.06/0.07/0.08/ 0.09/ <u>0.10</u> /0.20/0.30/ 0.40/0.50/1.00/2.00/ 5.00nm
	Danger	Enabled	Set whether to issue an alarm when a monitoring area is set around waypoints and own ship enters in the monitoring area. When a check mark is attached, this item is enabled and when the check mark is removed, this item is disabled.
		Value	Set a radius of the monitoring area when [Operation] is enabled. <u>Setting a radius</u> Select a digit to be set by using the   (Left/Right) keys, change the value by using the   (Up/Down) keys, and confirm the change by using the  (Center) or  key.
		0.00nm to <u>1.00nm</u> to 9.99nm	
AIS	Dangerous vessel		Set whether to issue an alarm when a 'Dangerous vessel' situation occurs. When a check mark is attached, this item is enabled and when the check mark is removed, this item is disabled.
ARPA(TT)	Dangerous vessel		Set whether to issue an alarm when a 'Dangerous vessel' situation occurs. When a check mark is attached, this item is enabled and when the check mark is removed, this item is disabled.
DGPS			Set whether to issue an alarm when differential positioning is disabled. When a check mark is attached, this item is enabled and when the check mark is removed, this item is disabled.
Restore default			Reset the setting values of the alarm menu to the default values. To reset, select [Yes]. To cancel reset, select [No].













8.13 Saving and calling settings–Memory menu



Item		Setting Contents	Setting value (Underline: Default value)
Save	Waypoints	<p>Saves the waypoints (mark) information that is stored in the processing unit in an external medium. Select a medium with the radio button.</p> <p>SD-1: Memory card that is inserted in Slot 1 (top side)</p> <p>SD-2: Memory card that is inserted in Slot 2 (bottom side)</p> <p>USB: USB memory</p> <p><u>Setting a file name</u></p> <p>When a medium is selected, a file name setting screen is displayed.</p> <p>Select a digit to be set by using the (Left/Right) keys, change the value by using the (Up/Down) keys, and confirm the change by using the (Center) or key.</p> <p>A folder is created under the name, “JRC DATA”, and the information is saved in the folder as a file. The file extension is “.dat”.</p>	<p><u>SD-1</u></p> <p>SD-2</p> <p>USB</p>









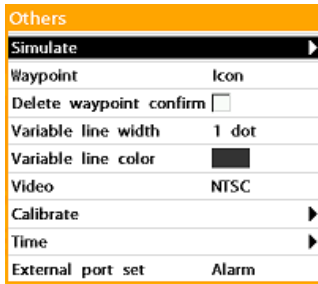

Item	Setting Contents	Setting value (Underline: Default value)
Routes	<p>Saves the route information that is stored in the processing unit in an external medium. Select a medium with the radio button.</p> <p>SD-1: Memory card that is inserted in Slot 1 (top side)</p> <p>SD-2: Memory card that is inserted in Slot 2 (bottom side)</p> <p>USB: USB memory</p> <p><u>Setting a file name</u></p> <p>When a medium is selected, a file name setting screen is displayed.</p> <p>Select a digit to be set by using the   (Left/Right) keys, change the value by using the   (Up/Down) keys, and confirm the change by using the  (Center) or  key.</p> <p>A folder is created under the name, "JRC DATA", and the information is saved in the folder as a file. The file extension is ".dat".</p>	<p><u>SD-1</u></p> <p>SD-2</p> <p>USB</p>
Tracks	<p>Saves the information of tracks that is stored in the processing unit in an external medium. Select a medium with the radio button.</p> <p>SD-1: Memory card that is inserted in Slot 1 (top side)</p> <p>SD-2: Memory card that is inserted in Slot 2 (bottom side)</p> <p>USB: USB memory</p> <p><u>Setting a file name</u></p> <p>When a medium is selected, a file name setting screen is displayed.</p> <p>Select a digit to be set by using the   (Left/Right) keys, change the value by using the   (Up/Down) keys, and confirm the change by using the  (Center) or  key.</p> <p>A folder is created under the name, "JRC DATA", and the information is saved in the folder as a file. The file extension is ".dat".</p>	<p><u>SD-1</u></p> <p>SD-2</p> <p>USB</p>











Item		Setting Contents	Setting value (Underline: Default value)
	User Line	<p>Saves the line information that is stored in the processing unit in an external medium. Select a medium with the radio button.</p> <p>SD-1: Memory card that is inserted in Slot 1 (top side)</p> <p>SD-2: Memory card that is inserted in Slot 2 (bottom side)</p> <p>USB: USB memory</p> <p><u>Setting a file name</u></p> <p>When a medium is selected, a file name setting screen is displayed.</p> <p>Select a digit to be set by using the   (Left/Right) keys, change the value by using the   (Up/Down) keys, and confirm the change by using the  (Center) or  key.</p> <p>A folder is created under the name, "JRC DATA", and the information is saved in the folder as a file. The file extension is ".dat".</p>	<u>SD-1</u> SD-2 USB
	System Configuration	<p>Saves the entire setting status in the System Configuration menu in an external storage medium.</p> <p>Select a medium with the radio button.</p> <p>SD-1: Memory card that is inserted in Slot 1 (top side)</p> <p>SD-2: Memory card that is inserted in Slot 2 (bottom side)</p> <p>USB: USB memory</p> <p>When a medium is selected, a file is created with the name, "jlz1000sys.cnf".</p>	<u>SD-1</u> SD-2 USB
Load	Waypoints/ Routes/ Tracks/User Line	<p>Select a medium that stores data to be loaded by using the radio button.</p> <p>SD-1: Memory card that is inserted in Slot 1 (top side)</p> <p>SD-2: Memory card that is inserted in Slot 2 (bottom side)</p>	<u>SD-1</u> SD-2 USB







Item		Setting Contents	Setting value (Underline: Default value)
	System Configuration	<p>USB: USB memory</p> <p>When [Waypoints/Route/Track & Log/User line] is selected and a medium is selected, a list of the files that are stored is displayed.</p> <p>Select a file to be called by using the   (Up/Down) key and confirm the selection by using the  (Center) or  key.</p> <p>When [System Configuration] is selected, a message is displayed prompting the confirmation of the execution of the call. To execute the call, select [Yes] and confirm the selection by using the  (Center) or  key.</p> <p>The contents of the file, "jlz1000sys.cnf", that were saved are loaded and this equipment restarts.</p>	<p><u>SD-1</u></p> <p>SD-2</p> <p>USB</p>
	Delete	<p>Select a medium to be deleted with the radio button.</p> <p>SD-1: Memory card that is inserted in Slot 1 (top side)</p> <p>SD-2: Memory card that is inserted in Slot 2 (bottom side)</p> <p>USB: USB memory</p> <p>When a medium is selected, a list of the files that have been saved is displayed.</p> <p>Select a file to be deleted by using the   (Up/Down) keys and confirm the selection by using the  (Center) or  key.</p> <p>When a confirmation message is displayed, select [Yes] and confirm the selection by using the  (Center) or  key.</p> <p>To cancel deletion, select [No].</p>	<p><Medium></p> <p><u>SD-1</u></p> <p>SD-2</p> <p>USB</p> <p><Confirmation message></p> <p>Yes</p> <p><u>No</u></p>

8.14 Setting others–Others menu





Item		Setting Contents	Setting value (Underline: Default value)
Simulate	Simulate	<p>Set whether to set the screen display to a simulation mode.</p> <p>In simulation mode, the screen is displayed as if actual navigation is implemented without input from sensors while the ship is not sailing.</p> <p>When a check mark is attached, this item is enabled and when the check mark is removed, this item is disabled.</p>	<p>Enable</p> <p><u>Disable</u></p>
	Mode	<p>Set a simulation type.</p> <p>When [Normal] is set, simulation is performed by using the cursor position as the starting point and using the values that were set in [Speed] and [Course].</p>	<p>Normal</p> <p><u>Demo</u></p>
	Speed	<p>Set a ship speed when [Normal] is set in [Mode].</p> <p><u>Setting a speed</u></p> <p>Select a digit to be set by using the   (Left/Right) keys, change the value by using the  (Up/Down) keys, and confirm the change by using the  (Center) or  key.</p>	0kn to <u>10kn</u> to 99kn
	Course	<p>Set a course when [Normal] is set in [Mode].</p> <p><u>Setting a bearing</u></p> <p>Select a digit to be set by using the   (Left/Right) keys, change the value by using the  (Up/Down) keys, and confirm the change by using the  (Center) or  key.</p>	<u>0°T</u> to 360°T

Item	Setting Contents	Setting value (Underline: Default value)
Waypoints	Set how waypoints are to be displayed. Icon: Only the symbol is displayed. Icon + Name: The symbol and the name are displayed. Selected: Display that is set in [Display method] of [Waypoints creation] screen.	<u>Icon</u> I+N Selected
Delete waypoint confirm	Set how to delete waypoint. Enable: Display the confirmation screen for deletion. Disable: Do not display the confirmation screen for deletion.	Enable <u>Disable</u>
Variable line width	Set a width of the variable cursor in dot units.	<u>1 dot</u> 2 dot
Variable line color	Set a color of the variable cursor.	16 colors are available for setting.
Video	Set an image signal system of the external video equipment. See Section 6.5.1.1 “Setting the equipment according to the image signaling system”.	<u>NTSC</u> PAL SECAM
Calibrate	Temperature offset	Calibrate the value of the temperature data that is received. <u>Setting an offset value</u> Select a digit to be set by using the   (Left/Right) keys, change the value by using the  (Up/Down) keys, and confirm the change by using the  (Center) or  key.
	Keel offset	Calibrate the value of the keel data that is received. <u>Setting an offset value</u> Select a digit to be set by using the   (Left/Right) keys, change the value by using the  (Up/Down) keys, and confirm the change by using the  (Center) or  key.

Item		Setting Contents	Setting value (Underline: Default value)
Time	Local offset	<p>Set a time difference from the universal standard time.</p> <p><u>Setting a time difference</u> Select a digit to be set by using the   (Left/Right) keys, change the value by using the   (Up/Down) keys, and confirm the change by using the  (Center) or  key.</p>	-13:00 to <u>+09:00</u> to +13:00
	Time format	Set a format of time display.	<u>24hours</u> 12hours
	Date format	<p>Set a format for date display.</p> <p>dd: Date is displayed in 01 to 31. DD: Date is displayed in 01 to 31. MMM: Month is displayed in three characters of JAN to DEC. MM: Month is displayed in 01 to 12. yy: Year is displayed in the last two digits of 00 to 99. YYYY: Year is displayed in 4 digits.</p>	dd/MMM/yy MMM/dd/yy dd/MM/yy MM/dd/yy <u>YYYY.MM.DD</u>
External port set		<p>Set a contact output function.</p> <p>Alarm: Used by connecting an external buzzer. Log pulse: Outputs a log pulse.</p>	<u>Alarm</u> Speed log

Section 9 Setting and Executing Shortcuts

By setting a specific mark or a function in a numeric key (keys  to ) of this equipment, the key can be used as a shortcut key.

By setting a mark in a numeric key, the mark can be registered simply by pressing the numeric key once only.





By setting a function in a numeric key, the function can be executed simply by pressing the numeric key once only.

9.1 Marks and functions that can be set

9.1.1 Marks that can be set

Marks that can be set in numeric keys are listed below.

This section also describes the mark registration procedure without setting in numeric keys (normal operation).

Mark	Description	Normal operation
Event mark	Mark to be registered in own ship	Hold down the  (Mark) key. Create on the [Create waypoint] screen. Use the following procedure to open the [Create waypoint] screen. 1 Hold down the  (Screen) key – [Waypoints] 2  (Menu) key – [Create]
Cursor mark	Mark to be registered in the cursor	Create on the [Create waypoint] screen. Use the following procedure to open the [Create waypoint] screen. 1 Activate the map screen. 2  (Menu) key – [New waypoint]

9.1.2 Functions that can be set

Functions that can be set in numeric keys are listed below.

This section also describes the function execution procedure without setting in numeric keys (normal operation).

Function		Description	Normal operation	
Setting anchorage		Register the anchor mark.	-	
ARPA(TT) track display		Switch the track display to On/Off.	Enable [Track & Log] - [Tracks] - [ARPA (TT) track display] in the system configuration menu.	
Page	Map screen	Switch the current screen (P.H, or P.1 to P.9) to the screen with numeric key set.	Switch by using the [Replace] button in the page menu.	
	2-screen display of a sonar screen (200kHz and 50kHz)			
	Data screen			
	Highway screen			
	Map screen (Display of 2 screens, left and right)			
	Map screen and sonar screen (50/200 split)			
	Map screen and sonar screen (200kHz)			
	Map screen and sonar screen (200kHz split and zoom)			
	Map screen and sonar screen (50kHz)			
	Map screen and sonar screen (50kHz split and zoom)			
	Sonar screen(200kHz)			
	Sonar screen (200kHz split and zoom)			
	Sonar screen(50kHz)			
	Sonar screen (50kHz split and zoom)			
	Waypoints list			Display by using [Waypoints] in the page menu.
	Route list			Display by using [Routes] in the page menu.
	Satellite information screen			Display by using [Satellite] in the page menu.
	Tide table screen		Display by using [Tides] in the page menu.	
AIS numeric display screen	Display by using [AIS] in the page menu.			
DSB screen	Display by using [DSB] in the page menu.			
NAVTEX screen	Display by using [Navtex] in the page menu.			

Function	Description	Normal operation
Chart level	Switch Chart level of the map screen.	Select [Chart] – [Chart symbol] in the system configuration menu and select one of [Page1] to [Page3].
AIS display	Sets display of the AIS target symbol to On/Off.	-
ARPA(TT) display	Sets display of the track target symbol to On/Off.	-
DSB(TT) display	Sets display of the DSB target symbol to On/Off.	-
GPS buoy display	Sets display of the GPS buoy symbol to On/Off.	-
Track depth display	Adds depth data to the track.	Set in the [Tracks] menu.
Track temperature display	Adds water temperature data to the track.	
Track current display	Adds current data to the track.	
Track date display	Adds a track date to the track.	
Track time display	Adds a track time to the track.	
User line drawing	Enter and delete user lines.	Display by using [User line drawing] in the map screen menu.
Setting New PEC expanded	Set isobath display	Display by using [Chart] – [Setting New PEC expanded] in the system configuration menu.

9.2 Setting marks and functions

Different event marks, cursor marks, or functions can be set in multiple numeric keys.

By this settings, different marks can be registered in own ship's positions and cursor positions without having to change the setting each time by using the multiple numeric keys and normal operations in different ways.

Multiple marks or functions cannot be set in one numeric key.

Memo

The following marks and functions are set in the numeric keys (F1 to F10) at factory delivery.

F1 to F3: Event mark

F4 to F9: Cursor mark

F10: Chart level

9.2.1 Setting a mark

This section describes the procedure for setting an event mark in numeric key [1].

Use the same procedure for setting an event mark or a cursor mark in some other numeric key.

1 Hold down the [1] key.

A [Shortcut key 1] screen is displayed.

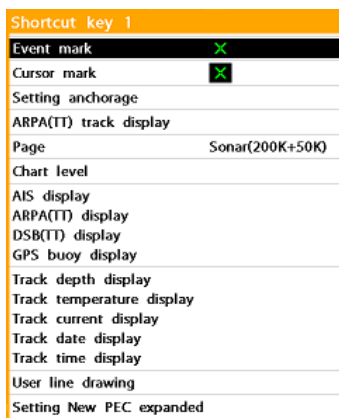

2 Select [Event mark] by using the

▲ ▼ (Up/Down) keys and confirm the selection by using the ⬜ (Center), ▶ (Right), or ⦿ key.

To set a cursor mark, select [Cursor mark].

A screen for selecting a mark shape is displayed.

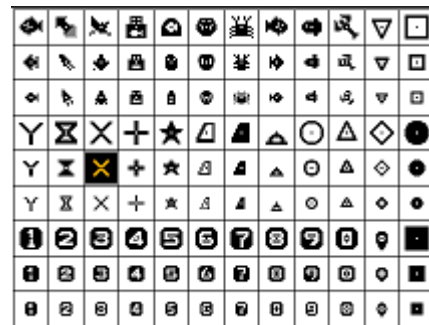

- 3 Select a mark shape by using the ▲ ▼ ◀ ▶ (Up/Down/Left/Right) keys and confirm the selection by using the ⬜ (Center) ⦿ key.

9.2.2 Setting functions

9.2.2.1 Setting an ARPA track display function

This section describes the procedure for setting an ARPA track display function in numeric key [2].

Use the same procedure for other numeric keys also.

1 Hold down the [2] key.

A [Shortcut key 2] screen is displayed.

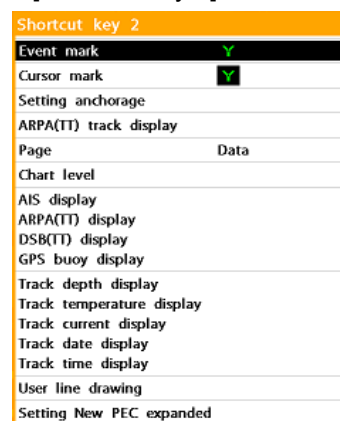

- 2 Select [ARPA(TT) track display] by using the ▲ ▼ (Up/Down) keys, and confirm the selection by using the ⬜ (Center), ▶ (Right), or ⦿ key.

9.2.2.2 Setting a screen switching function

This section describes the procedure for setting a screen switching function in numeric key [3]. Use the same procedure for other numeric keys also.

1 Hold down the [3] key.

The [Shortcut key 3] screen is displayed.

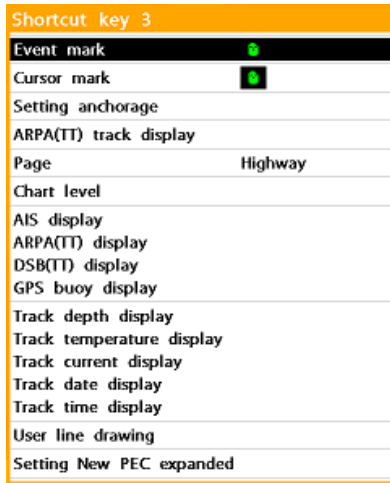

2 Select [Screen] by using the (Up/Down) keys and confirm the selection by using the (Center), (Right), or key.

Screen names are displayed.

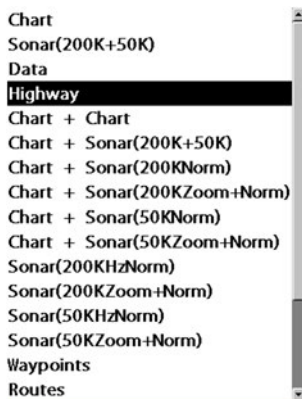

3 Select a screen to be set by using the (Up/Down) keys.

4 Confirm the selection by using the (Center), (Right), or key.

9.2.2.3 Setting a chart level switching function

This section describes the procedure for setting a chart level switching function in numeric key [4].

Use the same procedure for other numeric keys also.

1 Hold down the [4] key.

The [Shortcut key 4] screen is displayed.

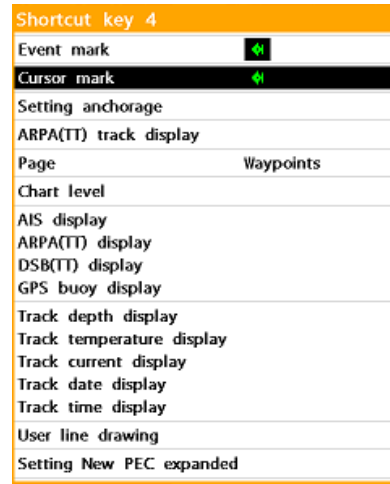

2 Select [Chart level] by using the (Up/Down) keys and confirm the selection by using the (Center), (Right), or key.

9.2.2.4 Setting various display functions

This section describes the procedure for setting a function that displays track data by adding depth data in numeric key [5].

Use the same procedure for other numeric keys also.

1 Hold down the [5] key.

The [Shortcut key 5] screen is displayed.



2 Select [Track depth display] by using the ▲▼ (Up/Down) keys and confirm the selection by using the ⏏ (Center), ▶ (Right), or ⏏ key.

9.3 Executing shortcut

9.3.1 Registering a mark

9.3.1.1 Registering a mark in the own ship's position

1 Display a map screen.

When the main screen is displayed by splitting, activate the map screen.

2 Press the numeric key with the Event mark set.

The mark is registered in the own ship's position.

Memo

When a mark is registered in the own ship's position by normal operation, the shape of the mark is as follows.

- Registering by holding down the  (Mark) key.:
Shape that is set in [Default mark] in the system configuration menu
- Displaying the menu by using [Waypoints] menu in the page menu and registering by using [Create]:

Shape that is set on the [Create waypoint] screen

9.3.1.2 Registering a mark in the cursor position

1 Display a map screen.

When the main screen is displayed by splitting, activate the map screen.

2 Press the numeric key with the Cursor mark set.

The mark is registered in the cursor position.

Memo

When a mark is registered in the cursor position by using [New waypoint] in the map screen menu, a shape of the mark can be selected on the [Destination setting] screen.

9.3.2 Switching an ARPA track display to On/Off

1 Display a map screen.

2 Press the numeric key with the ARPA track display function set.

9.3.3 Switching a screen

1 Display a main screen for switching by pressing the  (Screen) key.

Display any one of P.H, and P.1 to P.9.

2 Press the numeric key with the screen switching function set.

The screen is switched to the screen that was set.

When the numeric key is pressed again, the screen is switched to the P.H screen.

Memo

When the screen is switched to any of the following screens by using the numeric key, the screen is fixed to the switched screen.

Map screen/sonar screen/data screen/highway screen

To reset or switch to another screen, use the [Replace] button in the page menu.

9.3.4 Switching a chart level

1 Display a map screen.

When the main screen is displayed by splitting, activate the map screen.

2 After setting the chart level switching function, press the numeric key.

Whenever the key is pressed, the chart level switches between 3 levels.

Memo

The information that is displayed by each chart level can be changed by selecting [Chart] – [Chart level] in the configuration menu.

9.3.5 Displaying various screens



1 Display a main screen by pressing the  (Screen) key.



Display a required screen by pressing one of P.H and P.1 to P.9.

2 Press the numeric key with a required display function set.

Section 10 Maintenance and Inspection

The life of equipment is greatly influenced by the suitability of maintenance. To enable the equipment to demonstrate its maximum performance, carry out the following routine inspections.

 WARNING	
	Never overhaul or repair the unit by yourself. Overhauling or repairing of the unit by any person other than authorized service engineers could result in fires, electrical shocks, or failure.
	If overhauling or repair of the unit is required, contact us or our dealer.

 CAUTION	
	Always use specified fuses. Using fuses other than the specified fuses may result in fires or failures.

10.1 General maintenance and inspection

- Ensure that the power supply voltage is always maintained within the specified levels (11VDC to 35VDC).
- The following table shows the maintenance and inspection procedure by using general tools.

No.	Item	Maintenance and inspection
1	Cleaning	Remove any stains from the panel surfaces, dials, switches by wiping them off with soft cloth or silicon oil.
2	Loose parts	Check for any loose screws, nuts, and connectors and tighten them correctly.

- Check the state at normal operation with the contents displayed. Constantly compare the normal state with the existing state for early abnormality detection.

10.2 Troubleshooting

WARNING



Never overhaul or repair the unit by yourself.

Overhauling or repairing of the unit by any person other than authorized service engineers could result in fires, electrical shocks, or failure.



If overhauling or repair of the unit is required, contact us or our dealer.

The table below shows the guidelines for detecting failure sections.

Use these countermeasures except for the failures that require repair by JRC or your dealer.

Failure symptom	Assumed cause/failure cause	Countermeasure
Power is not supplied even if the power switch is turned on.	Power is not supplied from the power board.	Check if the wiring from the power board is normal.
	Power is not supplied from the power supply unit (optional).	Check if the wiring from the power supply unit is normal.
	The fuse that is connected to the power supply cable is blown.	After checking if the wiring is normal, replace the fuse.
	The fuse of the power supply unit (optional) is blown.	After checking if the wiring is normal, replace the fuse.
	The switch of the display is faulty.	Request repair to JRC or your dealer.
Not displayed on the LCD.	The LCD is faulty.	Request repair to JRC or your dealer.
The lamp does not light.		
An alarm does not sound.	The internal buzzer is faulty.	Request repair to JRC or your dealer.
No click sound is emitted.	The internal buzzer is faulty.	Request repair to JRC or your dealer.
Not received (from a sensor)	Sensor connection cable is broken.	Check the connection cable.
	The sensor is faulty.	Request repair to JRC or your dealer.
Not received (from external equipment)	The polarity of the serial cable is incorrect.	Check if the polarity is correct.
	The interface is incorrect.	Check if the interface is correct.
	The sentence that is input is not supported.	Check the input command and version.
Not transmitted (to external equipment)	Output is not set.	See Section 8.7 "Setting communication – Comms menu" for setting.
	The channel that is set is incorrect.	See Section 8.7 "Setting communication – Comms menu" for setting.
	The control display unit or connector unit is faulty.	Request repair to JRC or your dealer.

Section 11 After-Sales Service

11.1 Guarantee

- The normal guarantee period is one year from the purchase of the product although it depends on the rules of JRC.

11.2 Service parts retention period

- The retention period of the service performance parts of this product (parts required for retaining the functions of the product) is 10 years after manufacturing discontinuation.

11.3 Requesting for repair

If you suspect a failure, check again by reading Section 10.2 “Troubleshooting” thoroughly. If still recognizing an abnormality, stop using the product and contact your dealer or a branch office or sales office of JRC.

- During the guarantee period, repair will be performed by your dealer or JRC without charge at the location specified by JRC or your dealer if the product failed while it is used in a normal condition according to the description and instructions described in the instruction manual. Repair for the failures caused by mishandling, mistake, or irresistible force such as natural disaster or fire will be charged.
- For repair of the product after expiration of the guarantee period, if the function can be recovered by the repair and the customer requests the repair, we will perform repair. In this case, the actual product is to be sent to us or the product will be repaired on board by our engineer at the location specified by JRC or your dealer. If repair is not possible on board, the product will be repaired at the factory.
- Necessary information
 - Product name, model name, manufacturing number, date of purchase
 - Describe in as much detail as possible the condition of the abnormality (alarms that are issued and so on).
 - Name of your business office or organization, location, and telephone number

11.4 Recommendation of regular inspection and maintenance

Performance of the product may deteriorate due to the aging of parts although the situation varies depending on the use condition. Inspection and maintenance are recommended separate from the normal maintenance. For inspection and maintenance, please contact your dealer or a sales office of JRC. This is a charged service.

For any questions regarding the after-sales service, please contact the offices that are provided at the back cover of this manual.

Section 12 Disposal

12.1 Disposal of this equipment

Dispose of this equipment according to the bylaws or regulations of the local government.

12.2 About Chinese version RoHS

有害物质的名称及含量 (Names & Content of hazardous substances)

形式名(Type): JLZ-1000

名称(Name): Color Plotter

部件名称 (Part name)	有害物质 (Hazardous Substances)					
	铅 (Pb)	汞 (Hg)	镉 (Cd)	六价铬 (Cr(VI))	多溴联苯 (PBB)	多溴二苯醚 (PBDE)
室内装置 (Control Unit)	×	×	×	×	×	×
外部设备(Peripherals) ·选择(Options) ·电线类(Cables) ·手册(Documents)	×	×	×	×	×	×
本表格依据SJ/T 11364 的规定编制。 (This table is prepared in accordance with the provisions of SJ/T 11364.) ○：表示该有害物质在该部件所有均质材料中的含量均在GB/T 26572 标准规定的限量要求以下。 (Indicates that this hazardous substance contained in all of the homogeneous materials for this part is below the requirement in GB/T 26572.) ×：表示该有害物质至少在该部件的某一均质材料中的含量超出GB/T 26572 标准规定的限量要求。 (Indicates that this hazardous substance contained in at least one of the homogeneous materials used for this part is above the limit requirement)						

RE: 中华人民共和国电器电子产品有害物质限制使用管理办法
Measures for the Administration of the Restricted Use of the Hazardous Substances Contained in Electrical and Electronic Products of the People's Republic of China

Section 13 Specifications

13.1 Function specification

Valid display range		Mercator projection (latitude 85 degrees or less)
Chart data		Navigation electronic chart diagram, new pec/NAVIONICS chart
Display scale		Screen width 0.1 - 5000nm
Display operation mode		North Up, East Up, South Up, West Up, Course Up, Head Up, and Destination Up
Position data display		Latitude/longitude, long range navigation C, long range navigation A, Decca navigator system
Main screen display	Split	Map screen (new pec: 2-screen display possible/Navionics: 1 screen only), highway, various types of data, sounding, and video
	Non-split	Tide forecast, GPS reception, AIS information, DSB information and NAVTEX information (English text only)
Track	Saved information	Color, L/L, water temperature, depth, current 5 levels (current drift/current set)
	No. of points saved	500,000 points (Display: 50,000 points)
	Display color	7 colors (normal, depth, and temperature: switchable)
	Save interval	Time: 1, 2, 5, 10, 20, 30, 60, 120, 300, 600, 1200, 1800, 3600 seconds Distance: 0.01, 0.02, 0.05, 0.1, 0.2, 0.5, 1.0, 2.0, 5.0, 10.0 nm or Off
	Other ship's track	TT
AIS		300 targets (without saving main unit)
Mark (Destination)	Type	36 types
	No. of points saved	50,000 points Comment input 14 characters
	Display color	7 colors
Route		100 routes (1 route 100 waypoints) Comment input 14 characters
Line	No. of points saved	Solid line 50,000 points, Fill 50,000 points
	Display color	7 colors
Alarm		Destination arrival/exit, route exit/entry, anchor, danger, deep sea, shallow, water temperature, voltage low
Others		External event input and external buzzer output (log pulse changeable)

Serial communication	No. of input/output systems	NMEA0183, JRC: 2 output systems, 2 input systems NMEA2000: 1 system
	Format	NMEA0183(Ver1.5/2.1/2.3/4.0), JRC
	NMEA0183 output sentence	APA* ¹ , APB, BWR* ¹ , GGA, GLL, GSA, GSV, RMB* ¹ , RMC, VTG, XTE* ¹ , DBT* ¹ , DPT* ¹ , VHW* ¹ , MTW* ¹ , ZDA* ¹ , HDT* ¹
	NMEA0183 input sentence	DBK, DBS, DBT, DPT, GGA, GLL, GNS, GSV, HDG, HDT, MDA, MTA, MTW, MWD, MWV, RMC, RPM, VHW, VTG, VWT, ZDA, CUR, TTM, TLL
	NMEA2000 Output sentence	Water Speed(128259), Water Depth(128267), XTE(129283), NAV.Data(129284), NAV.Data(129285), COG & SOG(129026), GNSS position(129029), Water temp.(130310)
	NMEA2000 Input sentence	System date and time(126992), Vessel Heading(127250), Engine parameters/Rapid Update(127488), Engine parameters/Dynamic(127489), Trip parameters/Engine(127497), Engine parameters/Static(127498), Fluid level(127505), Water Speed(128259), Water depth(128267), Position/Rapid Update(129025), COG & SOG/Rapid Update(129026), GNSS Position Data(129029), GNSS DOPs(129539), GNSS Sats in View(129540), Wind Data(130306), Environmental Parameter-Water temp.(130310), Environmental Parameter(130311)

*¹: Ver4.0 only

13.2 Power Supply specification

Power supply voltage	DC11V - 35V
Power consumption	25W (Not including the power for display)

13.3 Environment conditions

Operating temperature range	Processing unit: -10°C to +50°C Operation unit: -15°C to +55°C
Storage temperature range	-25°C to +70°C
Waterproof	Processing unit: IP22 (floor-mount), IP20 (wall-mount) Operation unit: IP22
Vibration	IEC60945 ed.4 compliance
EMC	IEC60945 ed.4 compliance
Compass safety distance	Processing unit: 0.5m (STD), 0.3m (STEER) Operation unit: 0.2m (STD), 0.1m (STEER)

13.4 External dimension and weight

External dimension	Processing unit: 340(W) x 233.8(D) x 94.7(H) mm Operation unit: 290(W) x 123(D) x 42.5(H) mm
Weight	Processing unit: About 2.2 kg Operation unit: About 1.1 kg

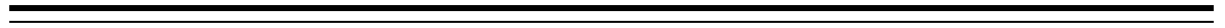

Section 14 Appendix/Reference Materials

14.1 Function menu table

The values that are set at factory delivery are indicated by .

The setting values are set to “Enable” or “Disable” by attaching or not attaching (removing) a check mark.

14.1.1 Map screen menu

 (Menu) key

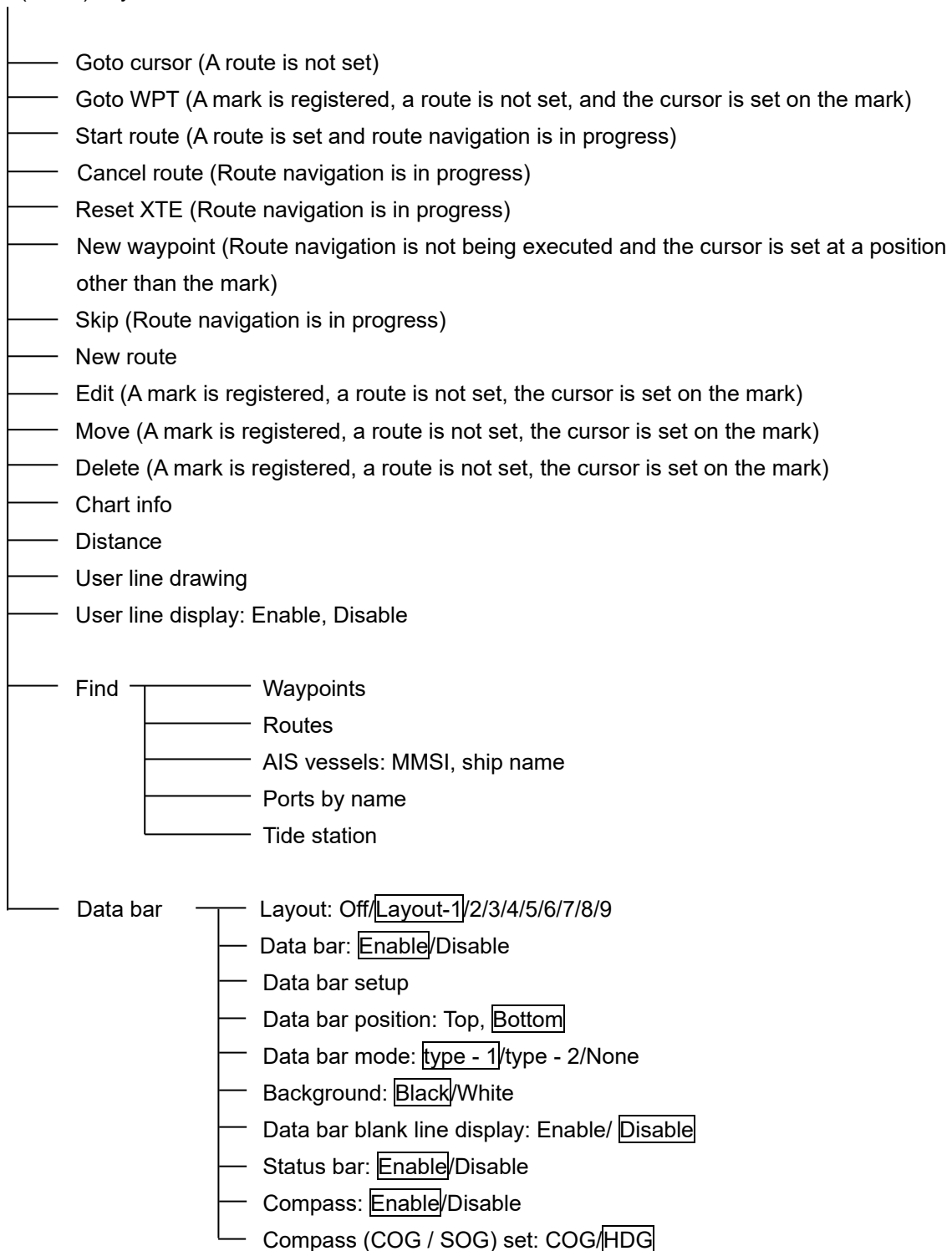

14.1.2 Highway screen menu

 (Menu) key

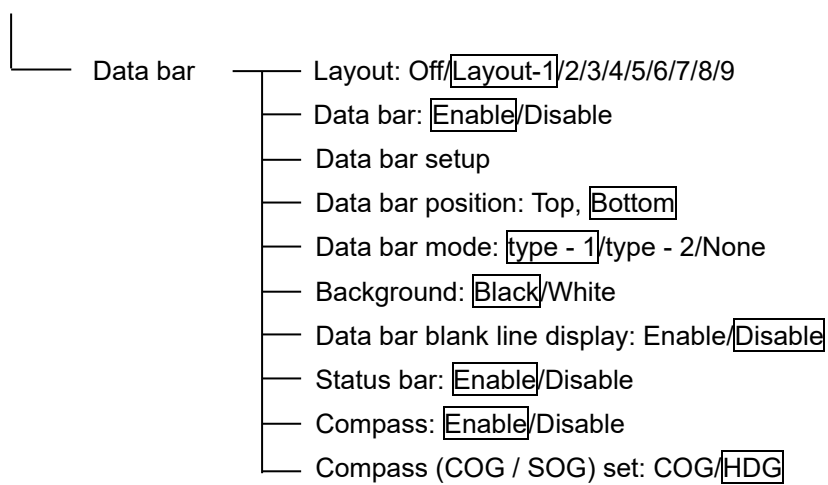

14.1.3 Data screen menu

 (Menu) key

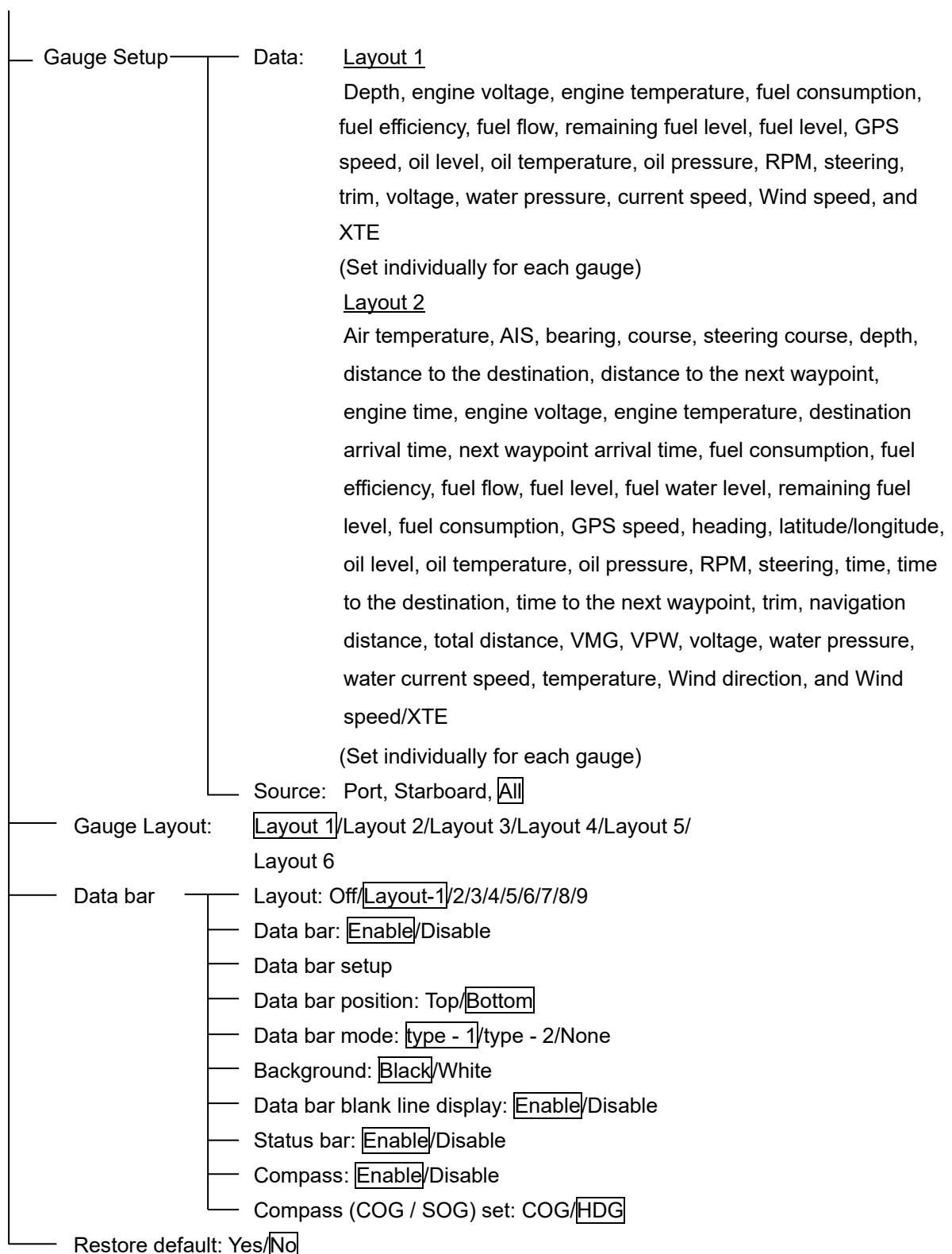

14.1.4 Depth screen menu



(Menu) key

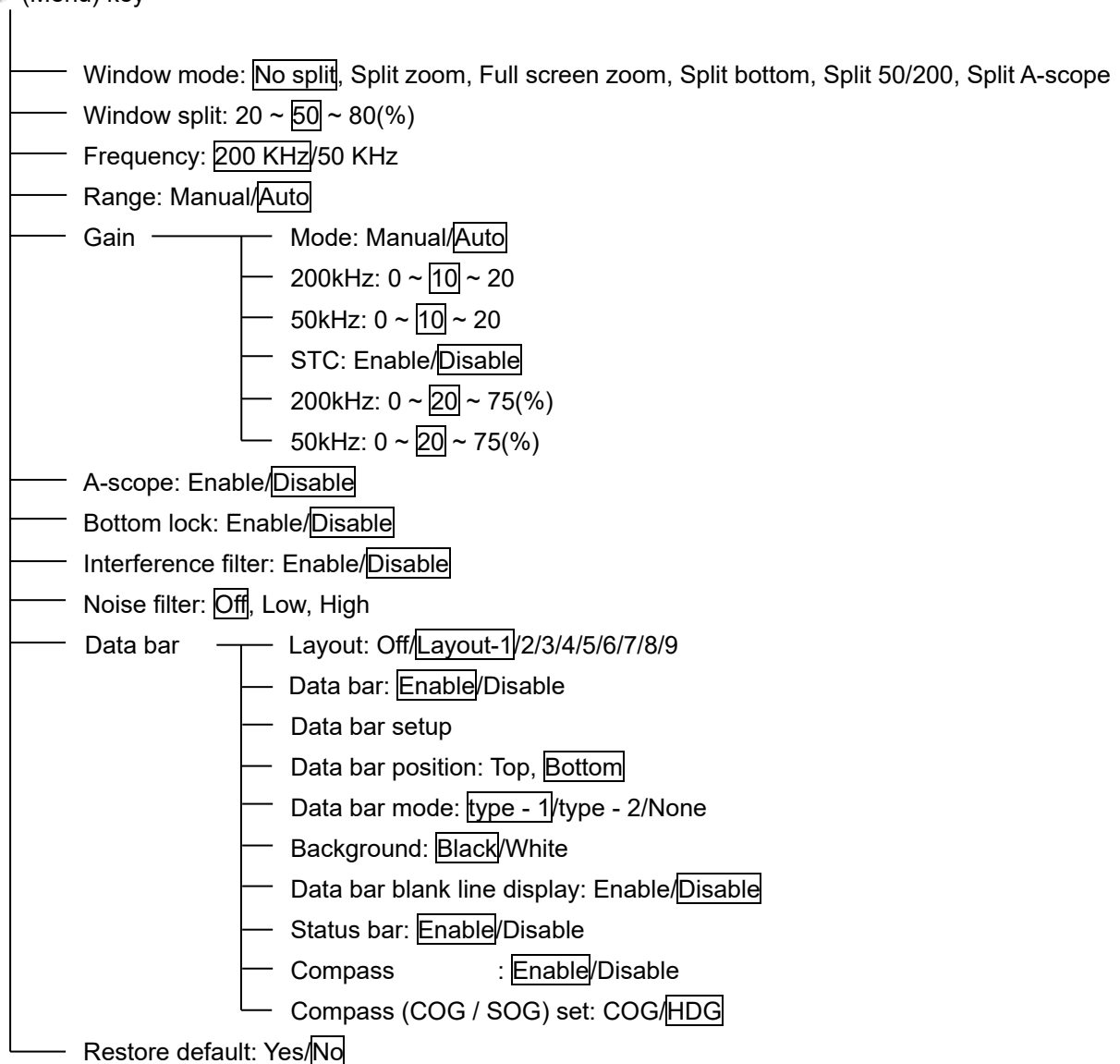

14.1.5 Video signal menu

 (Menu) key

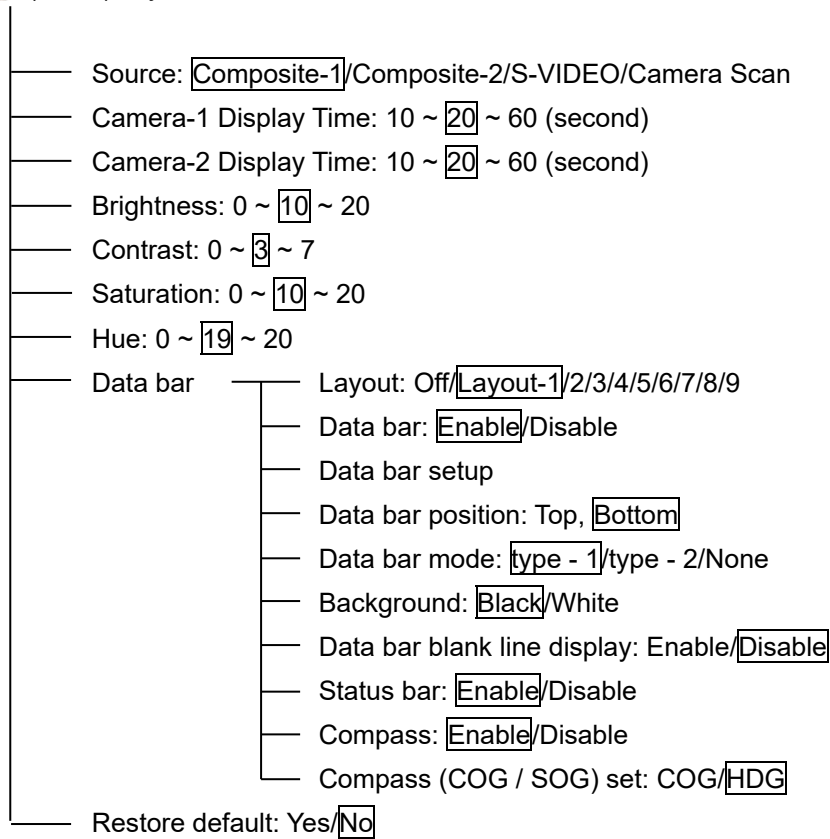

14.1.6 Tide table screen menu

 (Menu) key

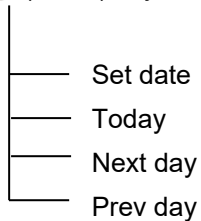

14.1.7 AIS numeric information screen menu

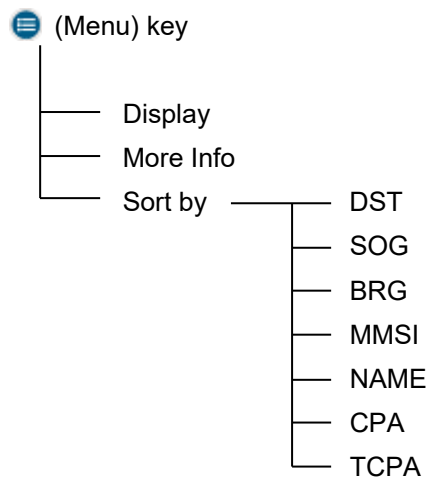

14.1.8 DSB information screen menu

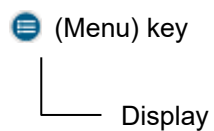

14.1.9 NAVTEX screen menu

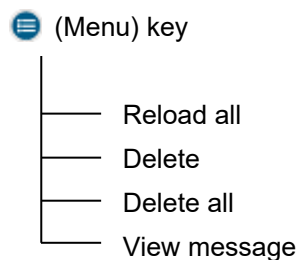

14.2 System Configuration menu table

The values that are set at factory delivery are indicated by .

The setting values are set to “Enable” or “Disable” by attaching or not attaching (removing) a check mark.

Hold down the  (Menu) key

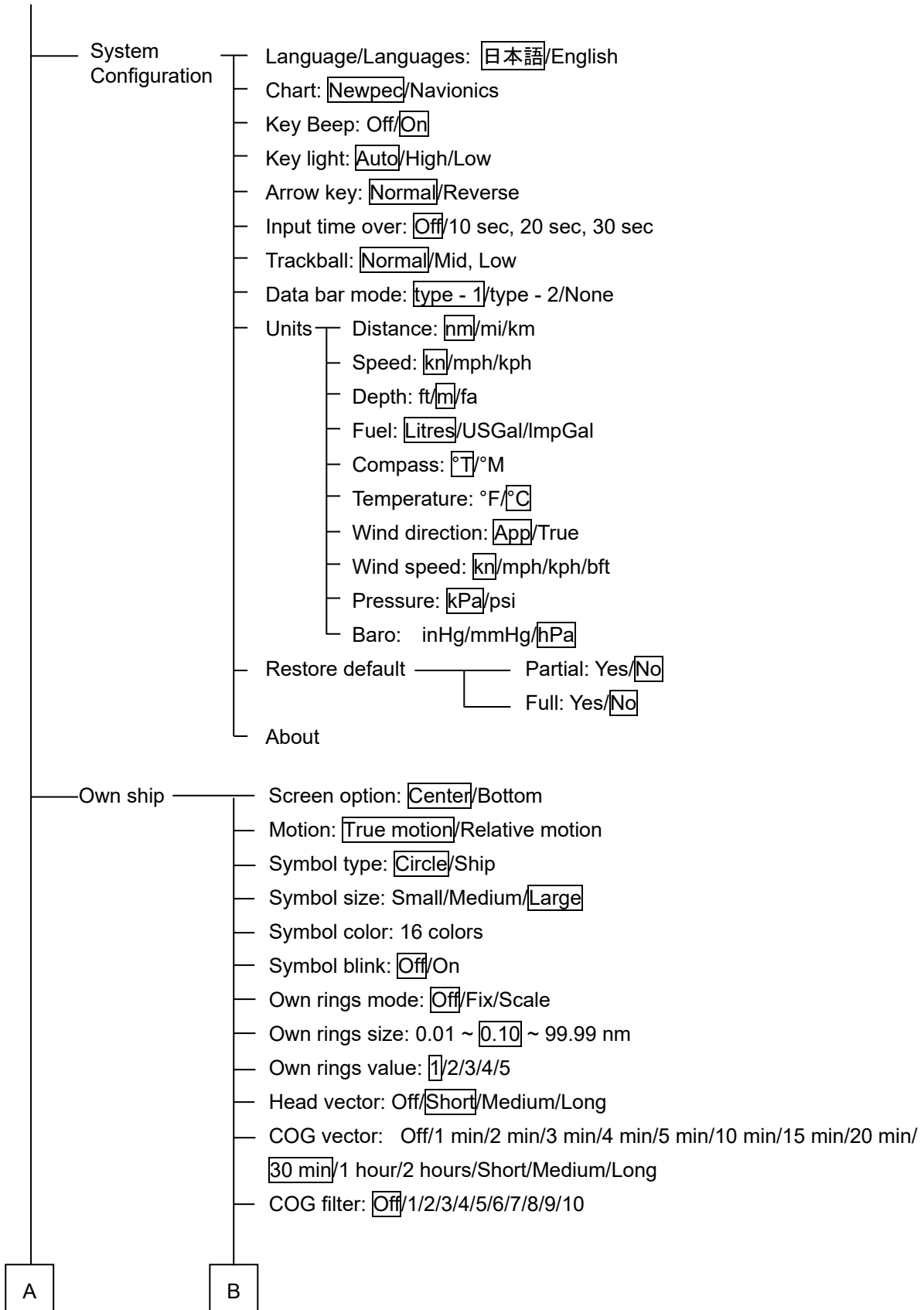

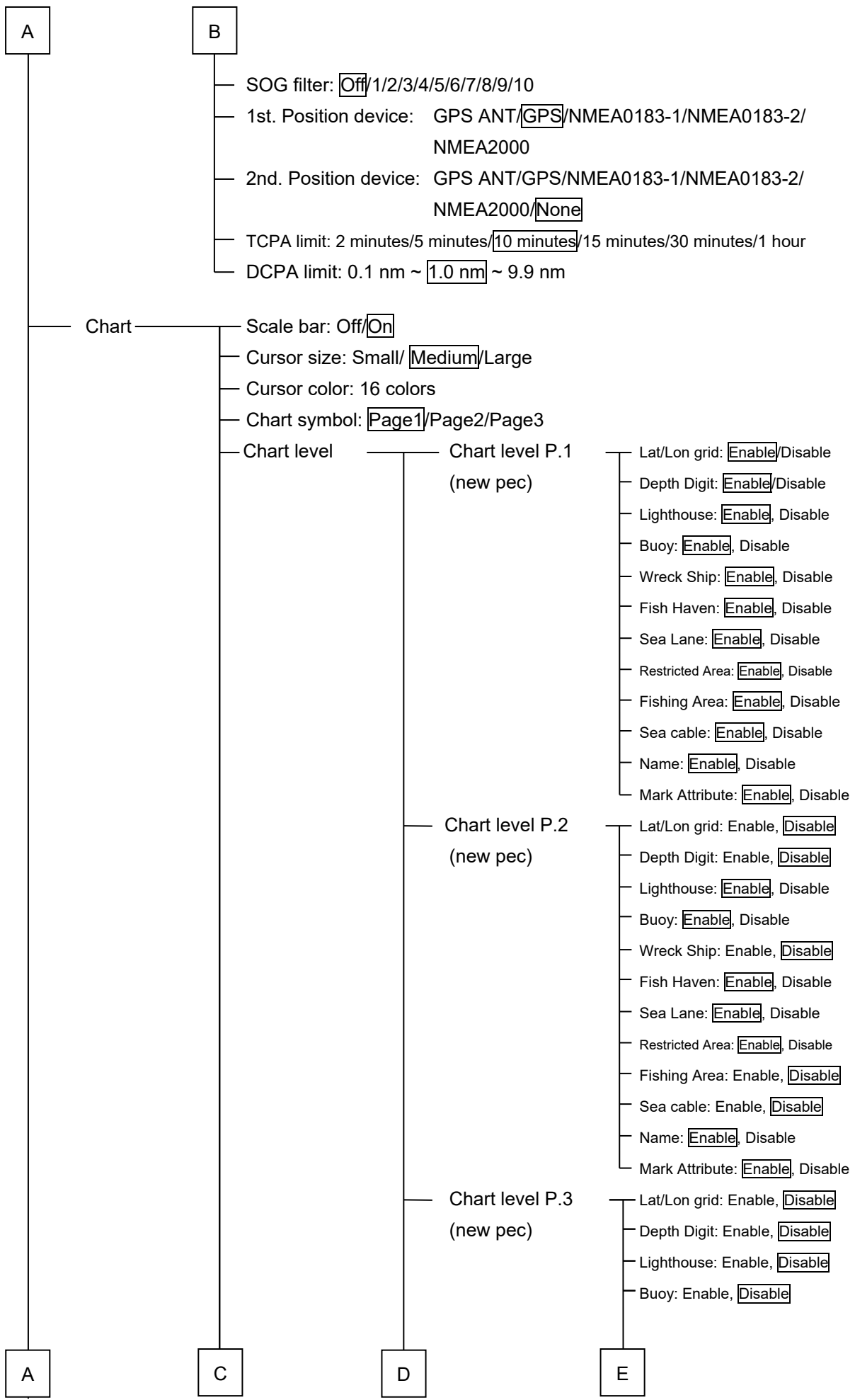

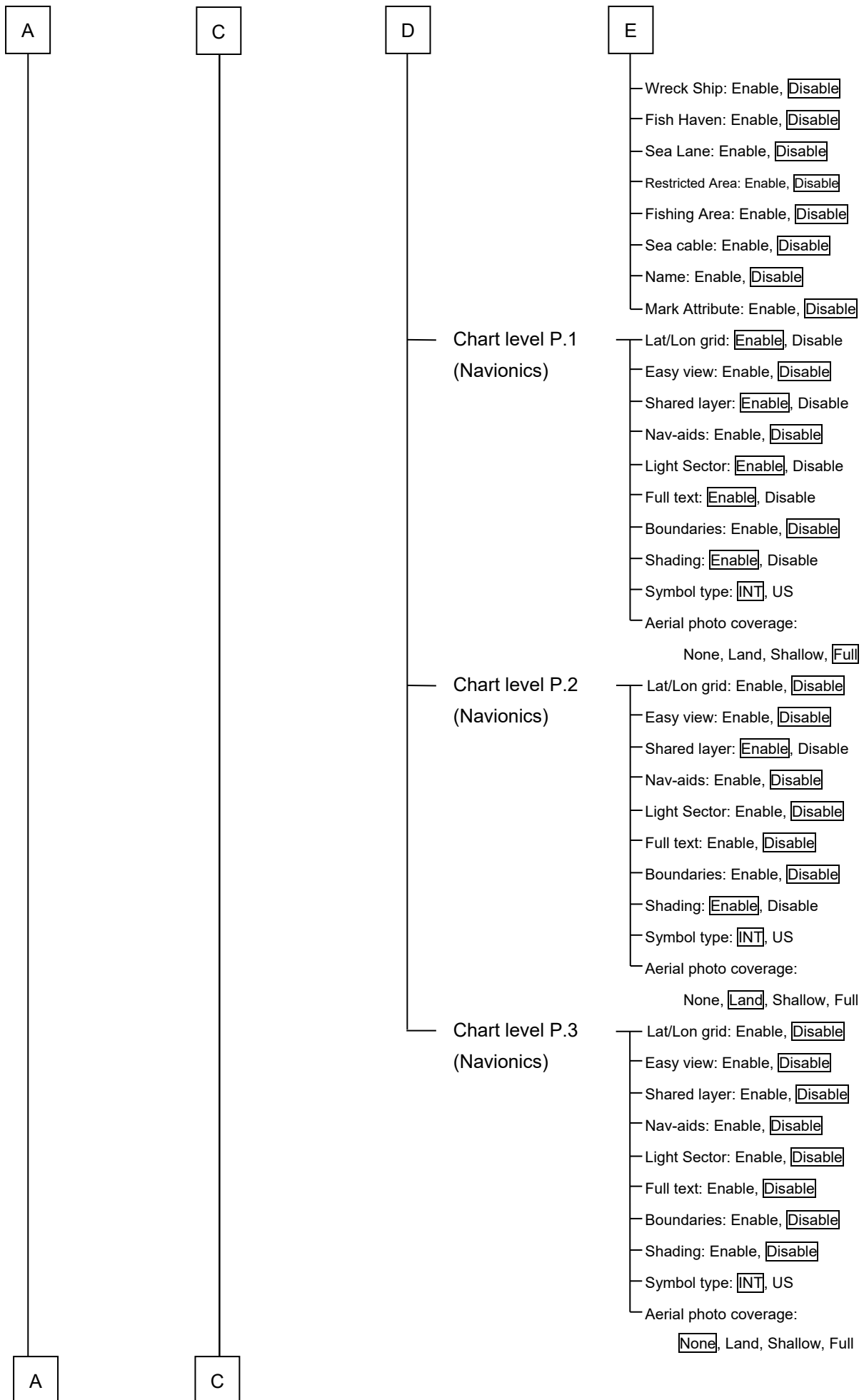

A

C

- Chart color change (new pec)
 - Sunlight
 - Land color: Standard/16 colors
 - Coast line color: Standard/16 colors
 - River/Lake color: Standard/16 colors
 - Sea color: Standard/16 colors
 - Night
 - Land color: Standard/16 colors
 - Coast line color: Standard/16 colors
 - River/Lake color: Standard/16 colors
 - Sea color: Standard/16 colors

- Setting
 - New PEC expanded: Enable, Disable
 - Using New PEC expanded: Standard/Customized-1 to 5
 - Expanded (new pec)
 - Customized-1
 - Low depth:
 - 1/1/1/21/31/51/101/201m
 - High depth:
 - 10/20/30/50/100/200/200~m
 - Interval:
 - 1/5/10/20/50/100/200/500m
 - Setting isobath:
 - 1m
 - Color: 16 colors
 - Line type: 4 kinds
 - 5m
 - Color: 16 colors
 - Line type: 4 kinds
 - 10m
 - Color: 16 colors
 - Line type: 4 kinds
 - 20m
 - Color: 16 colors
 - Line type: 4 kinds
 - 50m
 - Color: 16 colors
 - Line type: 4 kinds
 - 100m
 - Color: 16 colors
 - Line type: 4 kinds
 - 200m
 - Color: 16 colors
 - Line type: 4 kinds
 - 500m
 - Color: 16 colors
 - Line type: 4 kinds

- Customized-2 — Same as Customized-1 Interval: 5m
- Customized-3 — Same as Customized-1 Interval: 10m
- Customized-4 — Same as Customized-1 Interval: 20m
- Customized-5 — Same as Customized-1 Interval: 50m

A

C

A

C

Land & Sea(Navionics)

- Water feature: Enable/Disable
- Land features: Enable/Disable
- Spot soundings: Enable/Disable
- Spot soundings: 0 ~ m
- Safety depth: Enable/Disable
- Safety depth: 1 ~ ~ 20000m
- Depth contour: Enable/Disable
- Depth contour: 1 ~ ~ 20000m
- Rocks filter: Enable/Disable
- Rocks filter: 1 ~ ~ 20000m
- Shallow area: ~ 100m
- Fishing range minimum: ~ 10000m
- Fishing range maximum: ~ 10000m
- Canal: Enable/Disable
- Port object: Enable/Disable
- Colored seabed: Enable/Disable
- Dynamic tide & current: Enable/Disable

Default mark: 90 patterns

External mark: 90 patterns

Preset scale

- Preset scale 1: Off//0.05/0.1/0.2/0.5/
1.0/2.0/3.0/5.0/10.0/20.0/
50.0/100.0/200.0/300.0
- Preset scale 2: Off/0.01//0.1/0.2/0.5/
1.0/2.0/3.0/5.0/10.0/20.0/
50.0/100.0/200.0/300.0
- Preset scale 3: Off/0.01/0.05//0.2/0.5/
1.0/2.0/3.0/5.0/10.0/20.0/
50.0/100.0/200.0/300.0
- Preset scale 4: Off/0.01/0.05/0.1//0.5/
1.0/2.0/3.0/5.0/10.0/20.0/
50.0/100.0/200.0/300.0
- Preset scale 5: Off/0.01/0.05/0.1/0.2//
1.0/2.0/3.0/5.0/10.0/20.0/
50.0/100.0/200.0/300.0
- Preset scale 6: Off/0.01/0.05/0.1/0.2/0.5/
/2.0/3.0/5.0/10.0/20.0/
50.0/100.0/200.0/300.0

A

C

F

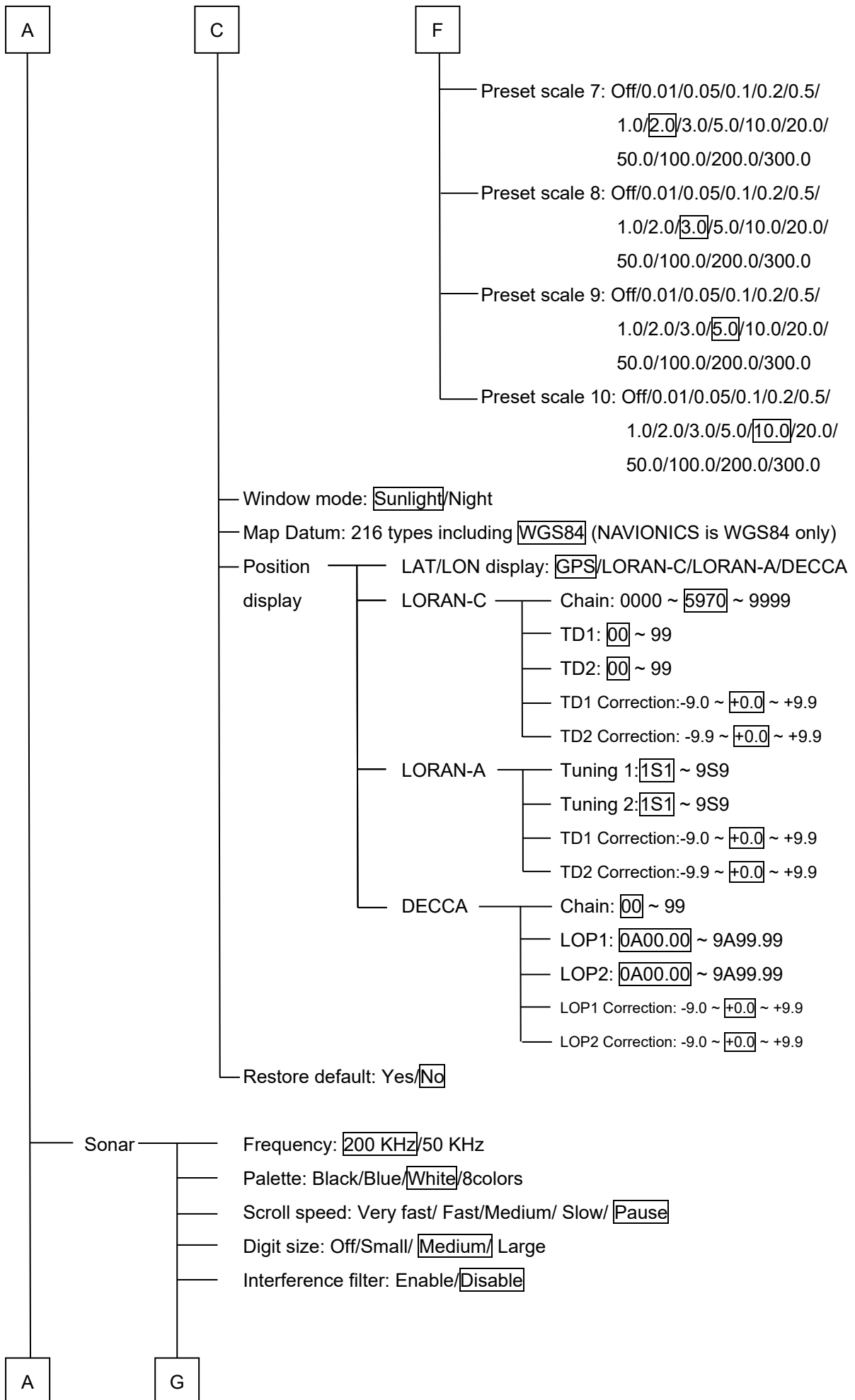

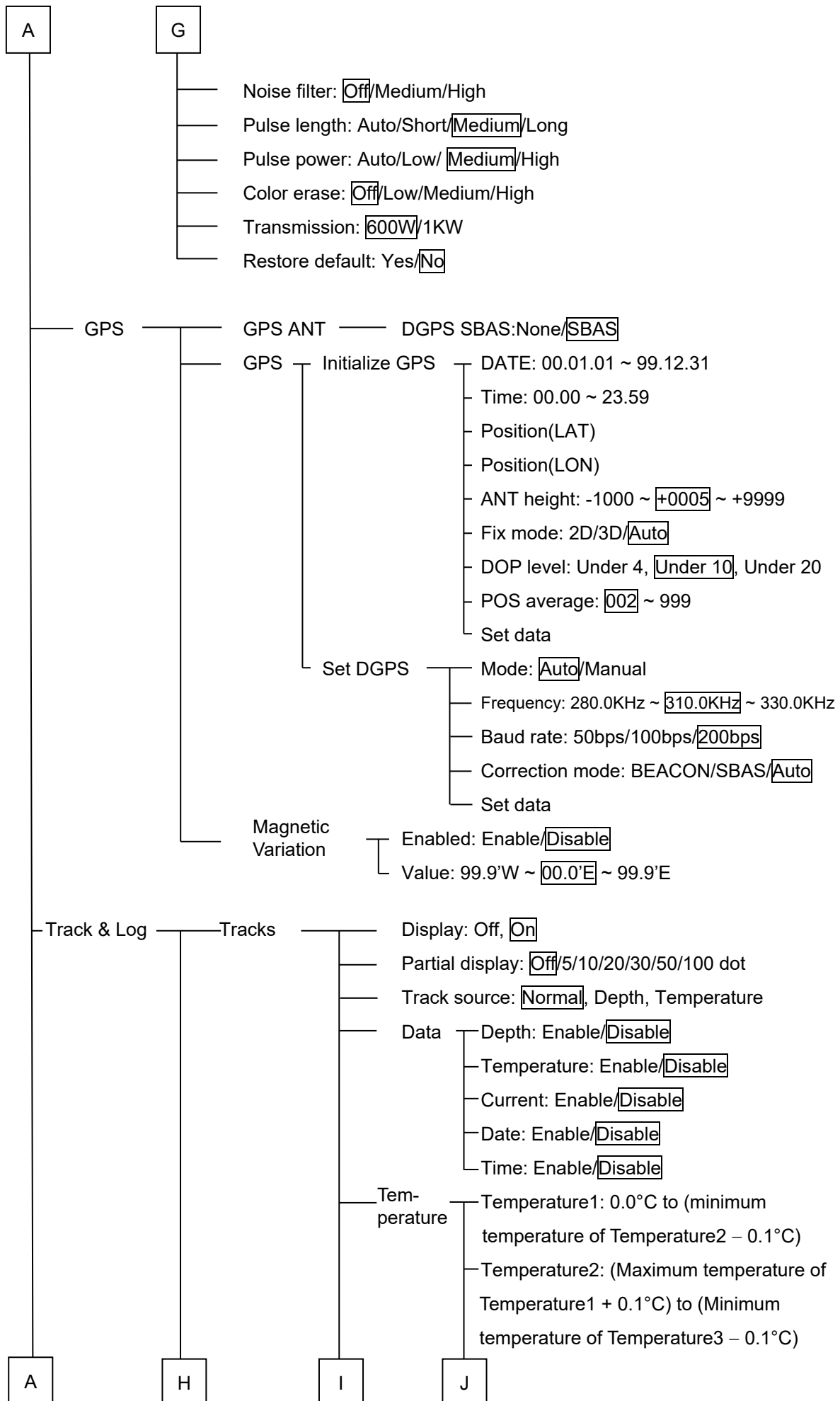

A

H

I

J

Temperature3: (Maximum temperature of Temperature2 + 0.1°C) to (Minimum temperature of Temperature4 – 0.1°C)

Temperature4: (Maximum temperature of Temperature3 + 0.1°C) to (Minimum temperature of Temperature5 – 0.1°C)

Temperature5: (Maximum temperature of Temperature4 + 0.1°C) to (Minimum temperature of Temperature6 – 0.1°C)

Temperature6: (Maximum temperature of Temperature5 + 0.1°C) to (Minimum temperature of Temperature7 – 0.1°C)

Temperature7: (Maximum temperature of Temperature6 + 0.1°C) to 40.0°C

Depth

Depth1: 10m to (Minimum depth of Depth2 – 1m)

Depth2: (Maximum depth of Depth1 + 1m) to (Minimum depth of Depth3 – 1m)

Depth3: (Maximum depth of Depth2 + 1m) to (Minimum depth of Depth4 – 1m)

Depth4: (Maximum depth of Depth3 + 1m) to (Minimum depth of Depth5 – 1m)

Depth5: (Maximum depth of Depth4 + 1m) to (Minimum depth of Depth6 – 1m)

Depth6: (Maximum depth of Depth5 + 1m) to (Minimum depth of Depth7 – 1m)

Depth7: (Maximum depth of Depth6 + 1m) to 999m

A

H

I

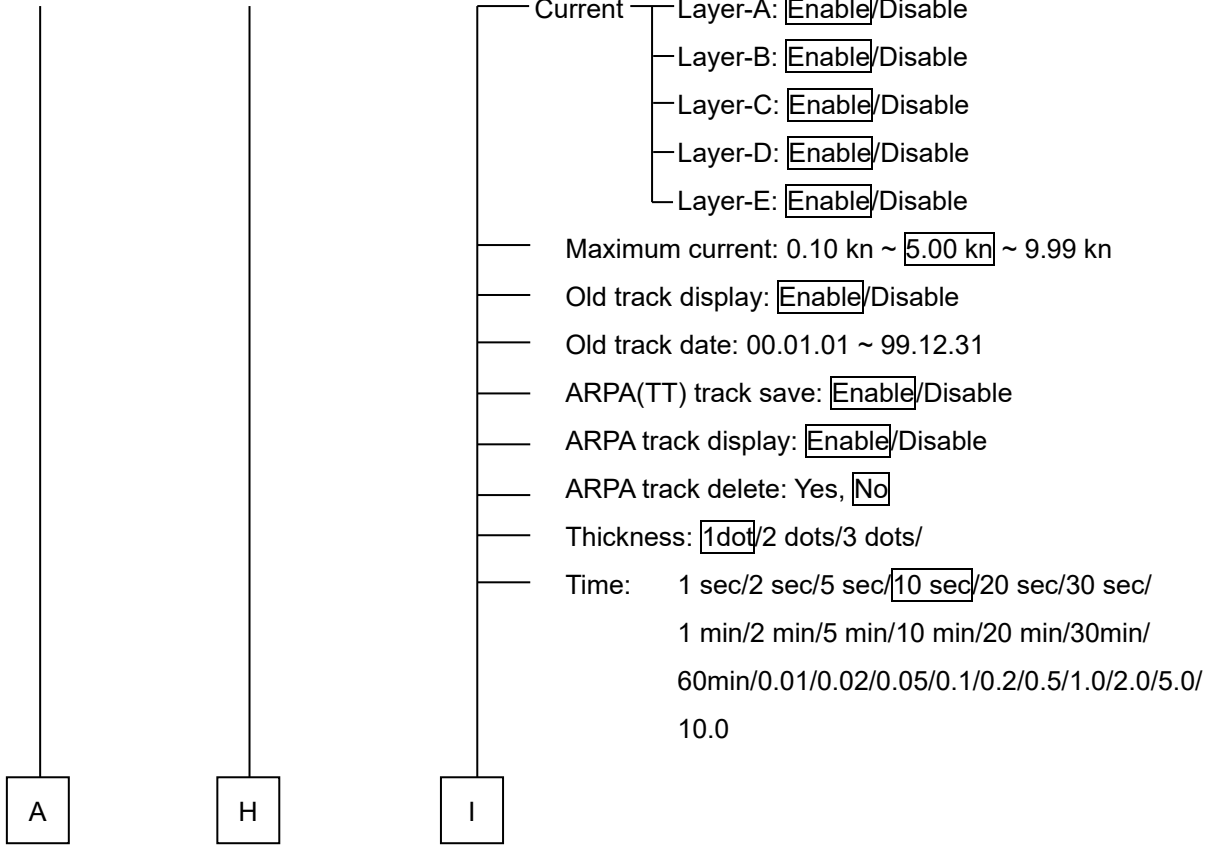

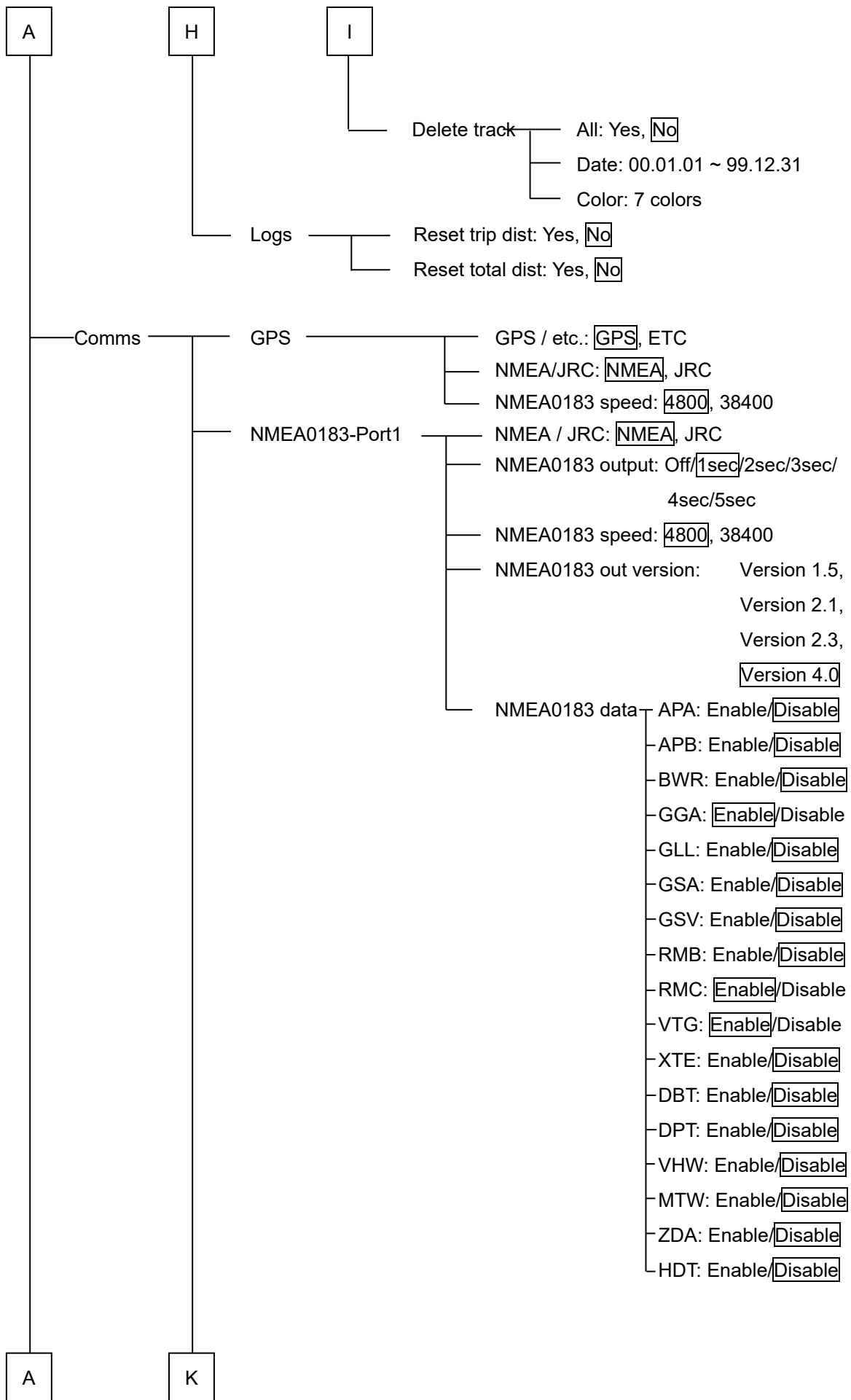

A

K

NMEA0183-Port2

NMEA / JRC: , JRC

NMEA0183 out: , 1sec/2sec/3sec/
4sec/5sec

NMEA0183 speed: , 38400

NMEA0183 out version: Version 1.5,
Version 2.1,
Version 2.3,

NMEA0183 data— APA: Enable/

— APB: Enable/

— BWR: Enable/

— GGA: Enable/

— GLL: Enable/

— GSA: Enable/

— GSV: Enable/

— RMB: Enable/

— RMC: Enable/

— VTG: Enable/

— XTE: Enable/

— DBT: Enable/

— DPT: Enable/

— VHW: Enable/

— MTW: Enable/

— ZDA: Enable/

— HDT: Enable/

NMEA2000

NMEA2000 out: Enable/

NMEA2000PGN — Water Speed (128259): Enable,

— Water depth (128267): Enable,

— XTE (129283): Enable/

— NAV. data (129284): Enable,

— NAV. data (129285): Enable,

— COG & SOG (129026): Enable,

— GNSS position (129029): Enable,

— Water temp. (130310): Enable,

Power: Enable/

Data view: , NMEA0183-1, NMEA0183-2, NMEA2000

A

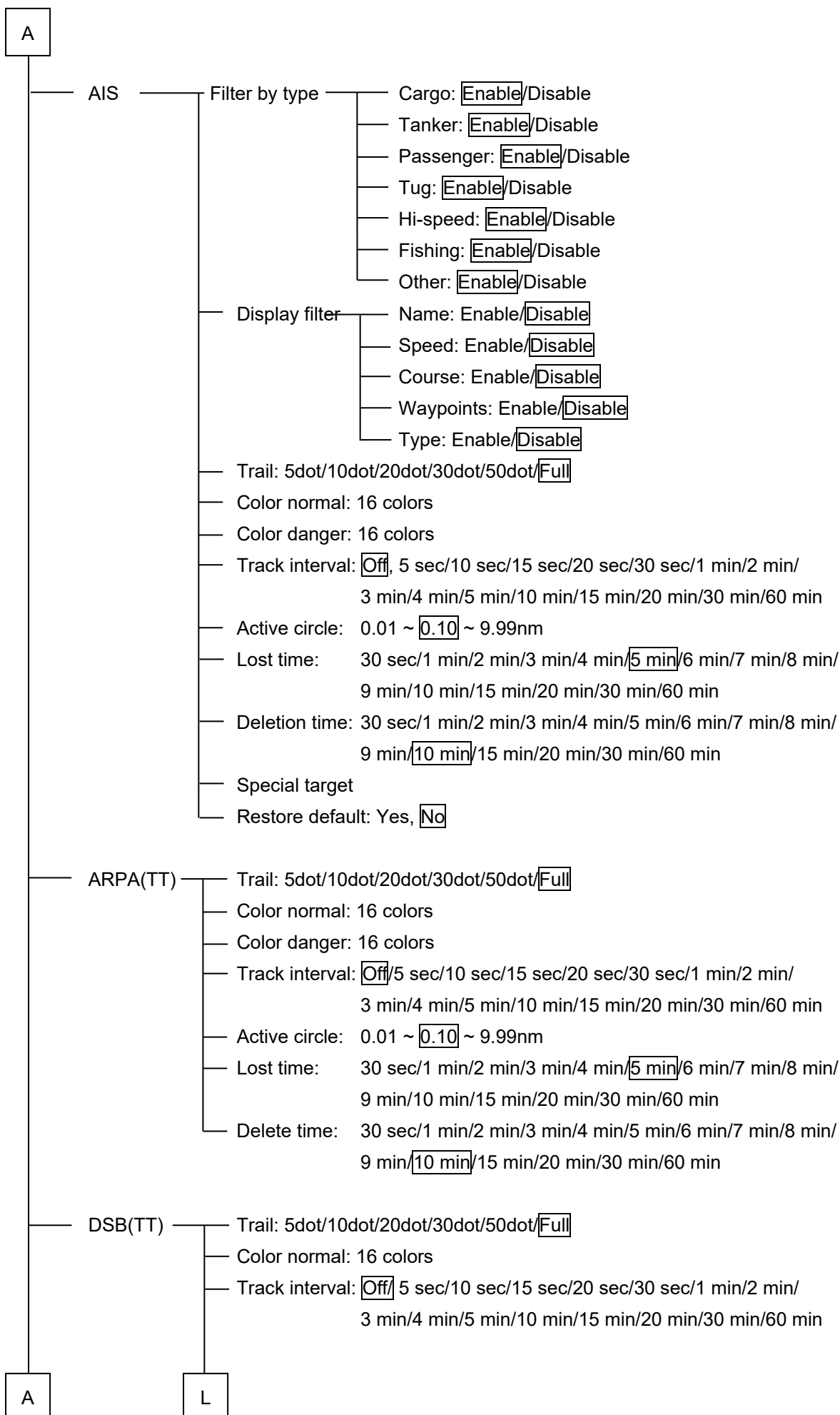

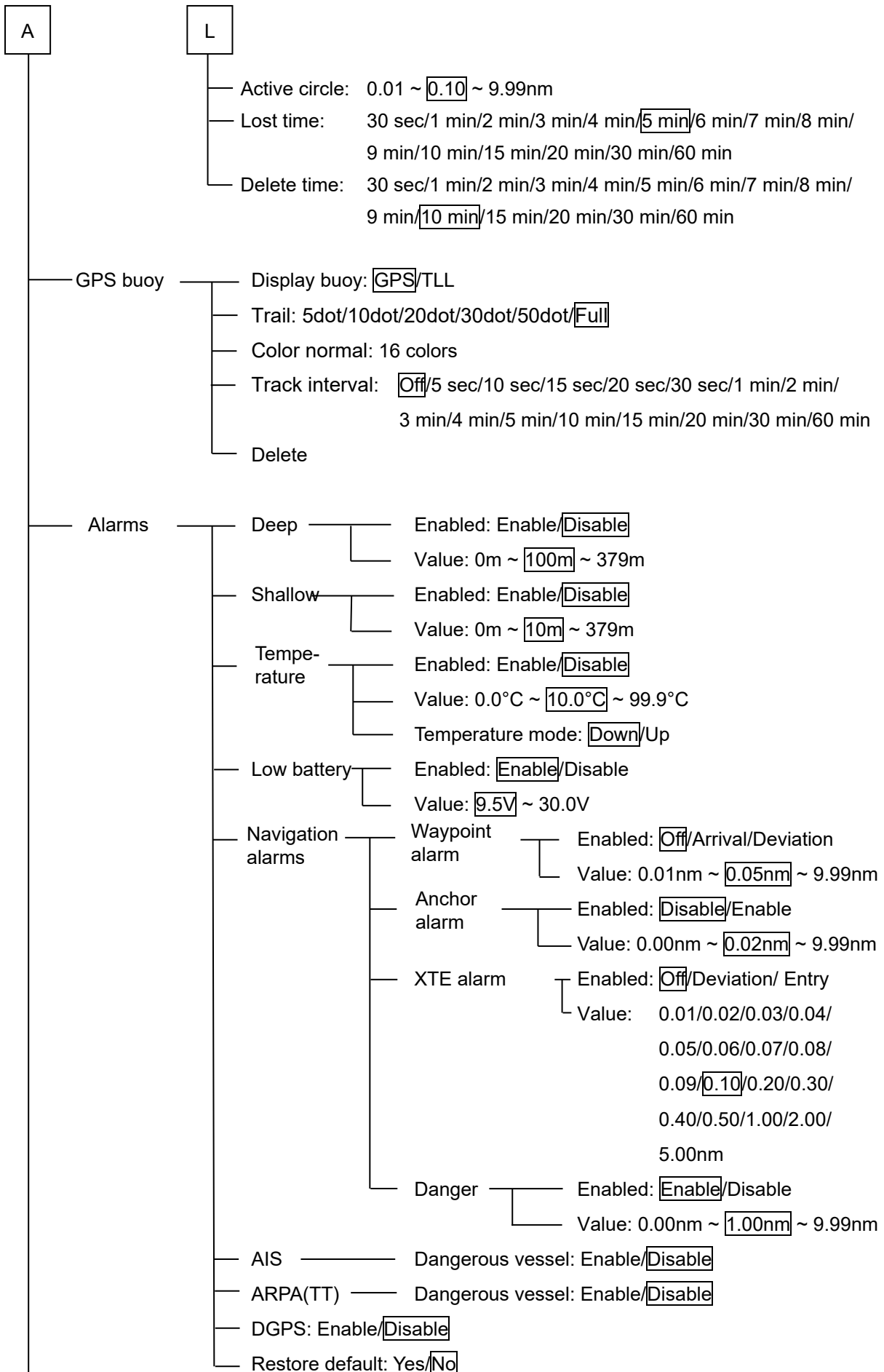

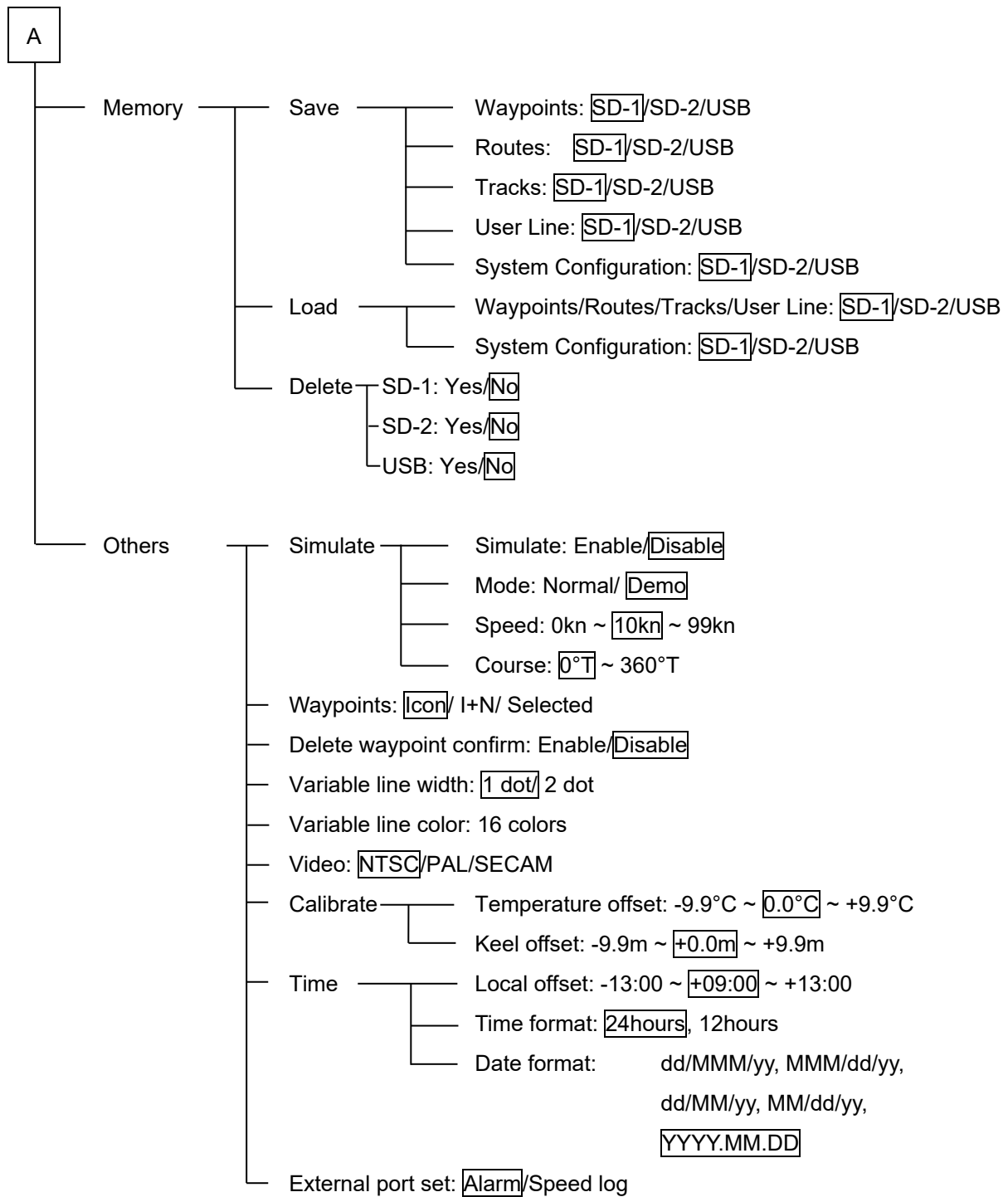

14.3 Data output format

14.3.1 Output sentence format

■GGA (GPS positioning information)

Version 1.5

\$GPGGA, hhmmss, ddmm.mmm, a, dddmm.mmm, a, x, x, xx, uxxxx, M, uxxx, M, xx, xxxx<CR><LF>
1 2 3 4 5 6 7 8 9 10 11 12 13 14

Version 2.1

\$GPGGA, hhmmss, ddmm.mmm, a, dddmm.mmm, a, x, xx, xx, uxxxx, M, uxxx, M, xx, xxxx*hh<CR><LF>
1 2 3 4 5 6 7 8 9 10 11 12 13 14 15

Versions 2.3 and 4.0

\$GPGGA, hhmmss.ss, ddmm.mmm, a, dddmm.mmm, a, x, xx, xx, uxxxx, M, uxxx, M, xx, xxxx*hh<CR><LF>
1 2 3 4 5 6 7 8 9 10 11 12 13 14 15

- 1 : UTC time (hour, minute, second)
Positioning at UTC [1/100 second] (Version 2.3 and 4.0)
- 2, 3 : Latitude (degree, minute), N/S
- 4, 5 : Longitude (degree, minute), E/W
- 6 : GPS positioning status 0=Non-positioning/1=GPS positioning/2=DGPS positioning
- 7 : Number of satellites using positioning
- 8 : HDOP(0 - 20)
- 9, 10 : Antenna sea level altitude (m), u: Sign (+, -)
- 11, 12 : Geoid height (m), u: Sign (+, -)
- 13 : DGPS data progress in seconds
- 14 : DGPS reference station ID, 0000 - 1023
- 15 : Check Sum

■RMC (Minimum positioning information)

Version 1.5

\$GPRMC, hhmmss, f, ddmm.mmm, a, dddmm.mm, a, xxx.x, xxx., xxxxxx, xx, a*hh<CR><LF>
1 2 3 4 5 6 7 8 9 10 11 12

Version 2.1

\$GPRMC, hhmmss, f, ddmm.mmm, a, dddmm.mmm, a, xxx.x, xxx., xxxxxx, xx., a*hh<CR><LF>
1 2 3 4 5 6 7 8 9 10 11 12

Version 2.3 and 4.0

\$GPRMC, hhmmss.ss, f, ddmm.mmm, a, dddmm.mmm, a, xxx.x, xxx.x, xxxxxx, xx., a, x*hh<CR><LF>
1 2 3 4 5 6 7 8 9 10 11 12 13

- 1 : UTC time (hour, minute, second)
Positioning at UTC [1/100 second] (Version 2.3 and 4.0)
- 2 : Status A=Enabled, V=Disabled
- 3, 4 : Latitude (degree, minute), N/S
- 5, 6 : Longitude (degree, minute), E/W
- 7 : Speed (Knot)
- 8 : Travel bearing (degree)
- 9 : UTC day, month, year
- 10,11 : Magnetism correction value, E/W
- 12 : Check Sum (Version 1.5 and 2.1)
- 12 : Mode Indicator (Versions 2.3 and 4.0)
A: GPS positioning in progress
D: DGPS positioning in progress
N: Not positioning
- 13 : Check Sum (Versions 2.3 and 4.0)

■GLL (Geographical position information)

Version 1.5

\$GPGLL, ddm,mmm, a, dddmm,mm, a<CR><LF>

1 2 3 4

Version 2.1

\$GPGLL, ddm,mmm, a, dddmm,mmm, a, hhmmss.ss, A*hh<CR><LF>

1 2 3 4 5 6 7

Version 2.3

\$GPGLL, ddm,mmm, a, dddmm,mmm, a, hhmmss.ss, A, x*hh<CR><LF>

1 2 3 4 5 6 7 8

- 1, 2 : Latitude (degree, minute), N/S
- 3, 4 : Longitude (degree, minute), E/W
- 5 : UTC time (hour, minute, second: 1/100 second is fixed to 00)
Positioning at UTC [1/100 second] (Version 2.3)
- 6 : Status A=Enabled, V=Disabled
- 7 : Check Sum (Versions 1.5 and 2.1)
- 7 : Mode Indicator (Versions 2.3 and 4.0)
 - A : GPS positioning in progress
 - D : DGPS positioning in progress
 - N : Not positioning
- 8 : Check Sum (Versions 2.3 and 4.0)

■VTG (Travelling direction and speed information)

Version 1.5

\$GPVTG, xxx.x, T, xxx.x, M, xxx.x, N, <CR><LF>

1 2 3 4 5 6

Version 2.1

\$GPVTG, xxx.x, T, xxx.x, M, xxx.x, N, xxx.x, K*hh<CR><LF>

1 2 3 4 5 6 7 8 9

Versions 2.3 and 4.0

\$GPVTG, xxx.x, T, xxx.x, M, xxx.x, N, xxx.x, K, x*hh<CR><LF>

1 2 3 4 5 6 7 8 9 10

- 1, 2 : Travel bearing (degree)
- 3, 4 : Magnetic bearing (degree)
- 5, 6 : Speed (knot)
- 7, 8 : Speed (km/h)
- 9 : Check Sum (Version 1.5, 2.1)
- 9 : Mode Indicator (Versions 2.3 and 4.0)
 - A : GPS positioning in progress
 - D : DGPS positioning in progress
 - N : Not positioning
- 10 : Check Sum (Versions 2.3 and 4.0)

■GSA (Positioning status and DOP information)

Version 2.1

```
$GPGSA, a, x, xx, xx, xx, xx, xx, xx, xx, xx, xx, xx, xx, xx, xx, xx, xx, xx, xx, xx*hh<CR><LF>  
 1 2 3 4 5 6 7 8 9 10 11 12 13 14 15 16 17 18
```

Versions 2.3 and 4.0

```
$GPGSA, a, x, xx, xx, xx, xx, xx, xx, xx, xx, xx, xx, xx, xx, xx, xx, xx, xx, xx, xx*hh<CR><LF>  
 1 2 3 4 5 6 7 8 9 10 11 12 13 14 15 16 17 18
```

- 1 : Positioning mode M=Manual selection (fixed to 2 dimension or 3 dimension),
A=automatic selection
- 2 : Positioning dimension 1=No positioning, 2=2 dimensional positioning,
3=3 dimensional positioning
- 3 to 14 : (fixed 4-digit length) (Version 2.1) (Version 2.1)
- 15 : PDOP (fixed 4-digit length) (Version 2.1)
- 16 : HDOP (fixed 4-digit length) (Version 2.1)
- 17 : VDOP (fixed 4-digit length) (Version 2.1)
- 18 : Check Sum (Version 2.1)
- 3 to 14 : (fixed 4-digit length) (Versions 2.3 and 4.0)
- 15 : PDOP (fixed 4-digit length) (Versions 2.3 and 4.0)
- 16 : HDOP (fixed 4-digit length) (Versions 2.3 and 4.0)
- 17 : VDOP (fixed 4-digit length) (Versions 2.3 and 4.0)
- 18 : Check Sum (Versions 2.3 and 4.0)

■GSV (Visible satellite reception status information)

Versions 2.1, 2.3, and 4.0 only

```
$GPGSV, x, x, xx, xx, xx, xxx, xx, xx, xx, xxx, xx, xx, xx, xxx, xx, xx, xx, xxx, xx*hh<CR><LF>  
 1 2 3 4 5 6 7 8 9 10 11 12 13 14 15 16 17 18 19 20
```

- 1 : Total number of GSV messages (1 to 3) (Version 2.1)
- 2 : GSV message sequence number (1 to 3) (Version 2.1)
- 1 : Total number of GSV messages (1 to 4) (Version 2.3)
- 2 : GSV message sequence number (1 to 4) (Version 2.3)
- 3 : Number of visible satellite
- 4 : PRN number of 1st satellite (01 to 32) (fixed 2-digit length)
Indicate the SBAS satellites from 120 to 138 with the numbers from 33 to 51 (Version 2.3)
Reserve 33 to 64 for SBAS satellites. (Version 2.3)
- 5 : 1st satellite elevation angle (00 to 32) (fixed 2-digit length)
- 6 : 1st satellite bearing angle (00 to 90 degrees) (fixed 3-digit length)
- 7 : 1st satellite SNR signal intensity C/No (00 to 99B) (fixed 2-digit length)
- 8 to 11 : 2nd satellite information (same as 4 to 7)
- 12 to 15 : 3rd satellite information (same as 4 to 7)
- 16 to 19 : 4th satellite information (same as 4 to 7)
- 20 : Check Sum (Version 2.1/2.3)

Note: Since one GSV sentence is formed by signals received from 4 satellites, the number of GSV sentences varies according to the number of satellites.

■ZDA (Date and time information)

\$GPZDA, hhmmss, xx, xx, xxxx, xx, xx*hh<CR><LF>

1 2 3 4 5 6 7

- 1 : UTC time (hour, minute, second)
- 2 : UTC day 01 to 31
- 3 : UTC month 01 to 12
- 4 : UTC year
- 5 : Hour (time difference/00 to ±13)
- 6 : Minute (time difference/00 to +59) (Version 2.1, Version2.3 (IEC))
- 7 : Check Sum

■APB (for Auto Pilot)

Version 1.5

\$GPAPB, A, A, x.x, a, N, A, A, x.x, a, c--c, x.x, a, x.x, a<CR><LF>

1 2 3 4 5 6 7 8 9 10 11 12 13 14

Versions 2.1, 2.3

\$GPAPB, A, A, x.x, a, N, A, A, x.x, a, c--c, x.x, a, x.x, a*hh<CR><LF>

1 2 3 4 5 6 7 8 9 10 11 12 13 14 15

Version 4.0

\$GPAPB, A, A, x.x, a, N, A, A, x.x, a, c--c, x.x, a, x.x, a, a*hh<CR><LF>

1 2 3 4 5 6 7 8 9 10 11 12 13 14 15 16

- 1 : Status A=Enabled, V=Disabled
- 2 : Status
- 3 : Off-course distance
- 4 : Steering direction L=Left R=Right
- 5 : Units nm
- 6 : Status A=Arrived V=Not arrived
- 7 : Status A=Passed through, V=Not passed through (IEC)
- 8, 9 : Distance from the starting position to the destination
M=Compass bearing T=True bearing
- 10 : Destination number
- 11, 12 : Bearing from own ship to the destination M=Compass bearing T=True bearing
- 13, 14 : Bearing from heading to the destination M=Compass bearing T=True bearing
- 15 : Check Sum (Version 2.1, 2.3)
- 15 : Mode Indicator (Version 4.0)
 - A : GPS positioning in progress
 - D : DGPS positioning in progress
 - N : Not positioning
- 16 : Check Sum (Version 4.0)

■BWR (Bearing and distance up to the destination)

\$GPBWR, hhmss.ss, llll.ll, a, yyyy.yy, a, x.x, T, x.x, M, x.x, N, c--c, a*hh<CR><LF>

1 2 3 4 5 6 7 8 9 10 11 12 13 14

1 : UTC time (hour, minute, second)
 Positioning at UTC [1/100 second]

2, 3 : Destination Latitude (degree, minute), N/S

4, 5 : Destination Longitude (degree, minute), N/S

6, 7 : Destination true bearing (degree)

8, 9 : Destination magnetic bearing (degree)

10, 11 : Distance up to the destination

12 : Destination number

13 : Mode Indicator
 A : GPS positioning in progress
 D : DGPS positioning in progress
 N : Not positioning

14 : Check Sum

■RMB (minimum navigation information)

\$GPRMB, A, x.x, a, c--c, c--c, llll.ll, a, yyyy.yy, a, x.x, x.x, x.x, A, a*hh<CR><LF>

1 2 3 4 5 6 7 8 9 10 11 12 13 14 15

1 : Status A=Enable V=Disable

2 : Off-course distance

3 : Steering direction L=Left R=Right

4 : Starting point number

5 : Destination number

6, 7 : Destination Latitude (degree, minute), N/S

8, 9 : Destination Longitude (degree, minute), N/S

10 : Distance up to the destination

11 : Destination bearing (degree)

12 : Destination approach speed

13 : Arrival state A=Arrived V=Not arrived

14 : Mode Indicator
 A : GPS positioning in progress
 D : DGPS positioning in progress
 N : Not positioning

15 : Check Sum

■XTE (Route deviation)

\$GPXTE, A, A, x.x, a, N, a*hh<CR><LF>

1 2 3 4 5 6 7

1 : Status A=Enabled V=Disabled

2 : Status

3 : Off-course distance

4 : Steering direction L=Left R=Right

5 : Units nm

6 : Mode Indicator
 A : GPS positioning in progress
 D : DGPS positioning in progress
 N : Not positioning

7 : Check Sum

14.4 Index

Alphabetical order

- Active screen
 - Switch, 4-5
- After-sales service, 11-1
- AIS menu, 8-21
- AIS numeric information screen, 6-15
- AIS numeric value information screen
 - menu, 7-14
- AIS target, 6-15
 - Check a position, 6-16
 - Display at activation, 8-21
 - Set, 8-21, 8-22
 - Sort, 6-17
- Alarms
 - Set, 8-28
- Alarms menu, 8-28
- Anchor alarm, 5-31
- ARPA track
 - Delete, 5-12
 - Display, 5-12
- ARPA(TT) menu, 8-24
- ARPA(TT) track
 - Save, 5-12
- Arrow key
 - Operation of the chart screen, 8-2
- Bearing mode
 - Display, 4-7
 - Switch, 5-5
- Button, 6-2
- Calibrate
 - Calibrate keel data, 8-37
 - Calibrate the value of the temperature data, 8-37
- CCTV/S-VIDEO
 - Connection, 3-17
- Character
 - Delete, 5-17
 - Hide, 5-16, 5-18
 - Write, 5-16
- Chart data version, 8-3
- Chart level
 - Set, 5-3
 - Setting at the factory delivery, 5-3
 - Switch, 5-4
- Chart menu, 8-7
- Circular cursor, 5-6
- COG filter, 8-5
- Comms menu, 8-19
- Compass area, 4-3
- Comprehensive system diagram, 1-5
- Contact output function
 - Set, 8-38
- CPA limit, 8-6
- Cross-track error
 - Re-set, 5-32
- Current
 - Attach to the track, 5-9
 - Display, 5-11
- Cursor
 - Set a color, 8-7
 - Size a size, 8-7
- Danger, 5-32
- Data bar, 4-3
 - Customize, 6-3
- Data screen, 6-8
 - Adjust an image quality, 6-13
 - Customize, 6-8
 - Set display information, 6-9
 - Switching the layout, 6-8
- Data screen menu, 7-8
- Date
 - Attach to the track, 5-9
- Date format, 8-38
- Day screen, 4-8
- DECCA, 8-12

Default mark, 8-10

Depth

- Attach to the track, 5-9
- Set a range, 5-11

Depth display, 6-10

DGPS

- Set, 8-31

Display, 6-2

Display language, 8-1

Disposal, 12-1

DSB information screen, 6-17

DSB information screen menu, 7-15

DSB target

- Set, 8-26

DSB(TT) menu, 8-26

External equipment

- Connection, 3-13

External event/external buzzer

- Connection, 3-15

External mark, 8-10

Factory reset

- System initialization, 8-3

Firmware version, 8-3

Floor-mounting installation, 3-2, 3-3

Flush-mounting installation, 3-6

Function menu, 4-8, 7-1

Geodetic system

- Display, 4-6

GND, 3-8

GPS antenna, 3-19

GPS buoy

- Set, 8-27

GPS Buoy menu, 8-27

GPS menu, 8-15

GPS port

- Set, 8-19

GPS positioning status, 4-6, 6-14

GPS receiver, 3-12

GPS signal

- Reception level, 6-14
- Reception state, 4-2

HDOP, 4-6

Heading vector length, 8-5

Highway screen, 6-7

Image signaling system, 6-12

Initialization

- Restore default, 8-12

Input signal (video)), 6-12

Interference filter, 8-13

Key Beep, 8-1

Key light

- Brightness, 8-2

Keyboard cable, 3-9

Line

- Delete, 5-17
- Draw, 5-14

Logs

- Reset, 8-18

LORAN-A, 8-12

LORAN-C, 8-11

Main screen, 4-3

- Switch, 4-4
- Undisplay screen, 6-6

Main screen number, 4-7

Maintenance and inspection, 10-1

Map

- Move, 5-2
- Switch, 5-33

Map screen menu, 7-2

Mark

- Check, 5-19
- Create a route by connecting, 5-26
- Delete, 5-21
- Delete all, 5-22
- Edit, 5-20
- Filter function, 5-24
- Move, 5-21
- Register, 5-19
- Register at the own ship's position, 5-20
- Search, 5-22
- Sort, 5-23

Mark color

- Select, 5-7
- Memory menu, 8-32
- Menu, 4-8
 - Display, 4-8
 - Level, 4-9
 - Operation example, 4-10
- Menu operation, 4-9
- MMSI, 6-16
 - Specify a special target, 8-23
- Monitor resolution
 - Setting, 3-11
- Motion mode, 4-7, 5-5
 - Set, 8-4
- Navigation alarms, 5-31
 - Set, 8-31
- Navionics
 - Land color/Sea color, 8-9
- NAVTEX screen, 6-18
 - Message text, 6-18
- NAVTEX screen menu, 7-16
- newpec
 - Display outline submarine topography, 8-7
- Night screen, 4-8
- NMEA port 1
 - Set, 8-19
- NMEA port 2
 - Set, 8-20
- NMEA2000
 - Connection, 3-18
- NMEA2000 port
 - Set, 8-20
- Noise filter, 8-13
- Offset
 - Local offset, 8-38
- Old track
 - Display, 5-12
 - Set a date, 5-12
- Operation unit, 1-3, 2-1
- Others menu, 8-36
- Own ship menu, 8-4
 - Own ship symbol
 - Blink On/Off, 8-4
 - Set a color, 8-4
 - Set a size, 8-4
 - Set a type, 8-4
 - Own ship's position, 8-4
 - Own ship's position icon, 4-6
 - Page menu, 4-8
 - Parallel index cursor, 5-6
 - Plotting mode, 5-14
 - Polygon
 - Delete, 5-16, 5-18
 - Draw, 5-15
 - Undisplay, 5-16, 5-18
 - Position data
 - Port for acquisition, 8-5
 - Power supply cable, 3-7
 - PRN code, 6-14
 - Processing unit, 1-4, 2-3
 - Received data
 - Display, 8-20
 - Restore default
 - Initialize AIS information, 8-22
 - Reset the alarm menu, 8-31
 - Sonar screen factory reset, 8-14
 - Ring based on own ship as the center, 8-4
 - Route
 - Check, 5-25
 - Connect marks, 5-26
 - Delete, 5-28
 - Display, 5-29
 - Edit, 5-27
 - Operate, 5-32
 - Set, 5-25
 - Route navigation
 - End, 5-30
 - Start, 5-30
 - Satellite information screen, 6-13
 - Save, 8-32
 - Scale
 - Switch, 5-2

Scale bar
 Display, 8-7

Scale value
 Preset, 5-1

Screen
 Replace, 6-5
 Save (Capture), 6-7
 Split display, 6-6

Screen brightness
 Switch, 4-8

SD card
 Connection, 3-21

Setting
 Change on the menu, 4-8
 Load, 8-35

Shortcut
 Execute, 9-7
 Marks and functions that can be set, 9-1
 Set, 9-4

Simulate, 8-36

SOG filter, 8-5

Sonar menu, 8-13

Sonar screen, 6-10
 Digit size, 8-13
 Image resolution, 8-14
 Image sensitivity, 8-14
 Scroll speed, 8-13
 Set a background color, 8-13
 Set a frequency, 8-13
 Switch a range, 6-11

Sonar screen menu, 7-9

Special target
 Set, 8-23

Specification
 SD card specification, 3-21
 USB memory specification, 3-21

Specifications, 13-1

Split display, 6-5
 Move a boundary, 6-6

Status bar, 4-3, 4-6

Switch patterns, 4-5

System Configuration menu, 4-8, 8-34
 Input wait time, 8-2

Target tracking target
 Set, 8-24

TCPA limit, 8-5

Temperature
 Attach to the track, 5-9
 Set a range, 5-10

Temporary destination
 Cancel route navigation, 5-30

Temporary destination Create, 5-30

Temporary route
 Cancel route navigation, 5-30
 Create, 5-29

Terminal block
 Installation, 3-16

Tide table screen, 6-14

Tide table screen menu, 7-13

Time, 8-38
 Attach to the track, 5-10

Track
 Delete, 5-13
 Recording interval, 5-13
 Set details, 5-8

Track & Log menu, 8-17

Track color
 Display, 4-6
 Select, 5-7

Trackball, 2-1, 5-2
 Amount of display movement, 8-2

Transducer
 Connection, 3-20

Transmission
 Display transmission power, 8-14

Troubleshooting, 10-3

Turning on/off, 4-1

Units
 Set, 8-2

USB memory
 Insertion, 3-21

Variable cursor, 5-6

Variable line	Add, 5-27
Set a color, 8-37	Delete, 5-28
Set a variable line width, 8-37	Skip, 5-32
Video screen, 6-12	Waypoint alarm, 5-31
Video screen menu, 7-12	XTE alarm, 5-32
Video signal cable, 3-10	Zoom In/Zoom Out
Wall-mounting installation, 3-4, 3-5	Map screen, 5-1
Waypoint	

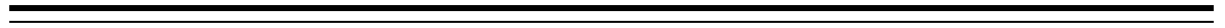

アスベストは使用していません
Not use the asbestos

For further information, contact:

JRC *Japan Radio Co., Ltd.*

Since 1915

URL Head office : <http://www.jrc.co.jp/eng/>

Marine Service Department

1-7-32 Tatsumi, Koto-ku, Tokyo 135-0053, Japan

e-mail : tmsc@jrc.co.jp

One-call : +81-50-3786-9201

ISO 9001, ISO 14001 Certified

CODE No.7ZPNA4661

AUG. 2018 Edition 3