

ALPHATRON

ALPHA BNWAS Bridge Navigational Watch Alarm System

Installation & Operation manual





The information in this Manual is subject to change without notice and does not represent a commitment on the part of ALPHATRON MARINE B.V.

Document : Manual Alphontron ALPHA BNWAS
Issue : 1.0
Date : 06-12-2012
© ALPHATRON MARINE B.V.

ALPHATRON MARINE B.V.

Schaardijk 23
3063 NH ROTTERDAM
The Netherlands
Tel: +31 (0)10 - 453 4000
Fax: +31 (0)10 - 452 9214

P.O. Box 210003
3001 AA ROTTERDAM

Web: www.alphontronmarine.com
Mail: service@alphatronmarine.com



CAUTION!



DO NOT modify this equipment in any way without obtaining a written permission from **ALPHATRON MARINE** otherwise you will void the warranty.

CAUTION!



This product is only to be installed by a certified installation company either approved by ALPHATRON MARINE or by one of its distributors, otherwise you will void the warranty. This product must be installed according to the prescribed installation methods in this manual, otherwise you will void the warranty.

CAUTION!



The components of the ALPHA BNWAS system contain no operator serviceable parts. Service and repair of both units shall only be done by trained and certified personal.



CONTENTS:

1	INTRODUCTION :.....	5
2	ALPHA BNWAS HARDWARE	6
3	OPERATION	8
4	TECHNICAL SPECIFICATIONS.....	10
5	VDR COMMUNICATION INTERFACE	11
6	TECHNICAL DRAWINGS	12



1 INTRODUCTION :

The ALPHA BNWAS Bridge Navigational Watch Alarm System is flexible in use and complies to the latest International regulations (Approved according to IMO Resolution 128(75)). This BNWAS system is applicable on all sea-going vessels.

The ALPHA BNWAS has an internal buzzer and at the same time a relay for an audio alarm at the bridge. Also there are 2 relays contacts to call the officer and to call the crew.

Between the "call officer" and the "call crew" stage the time is adjustable from 90 to 180 seconds. This adjustment can be made by a 16-position switch which is located next to the big chip on the print.

Normally this switch will be in the default zero position (90 sec.) This time may be adjusted to the maximum time of 180 seconds when the watch alarm is placed on for example a large passenger vessel.

The status of the relays and buzzer are visualized by the three red LED's on the top of the front panel. When the watch alarm is malfunctioning or the power supply is not connected, the watch alarm will generate an alarm message on your monitoring system by opening the malfunction contact.

All LED's except for those of the "call officer" and "call crew" are dimmable in five stages which can be performed by holding the reset button for more than 1 second. The reset button is tamper proof because the time system will only recover on the rising edge of the internal and external reset input. The run led will flash when the watch time is running and is also available on the Alarm Buzzer or Remote Reset Button. The BNWAS control unit is provided with an emergency call function, this mode can be activated when immediate help is needed on the bridge.

The ALPHA BNWAS is Lloyd's register approved.



2 ALPHA BNWAS HARDWARE

The basic hardware of the ALPHA BNWAS consists of the control unit. The characteristics of this control unit are:

- ❑ Dimensions 144x72x135 mm (DIN);
- ❑ Power supply: 18-33 Vdc;
- ❑ Current: 145 mA max;
- ❑ 4x potential free output;
- ❑ Autopilot input;
- ❑ Reset input.



The mounting details are as following:

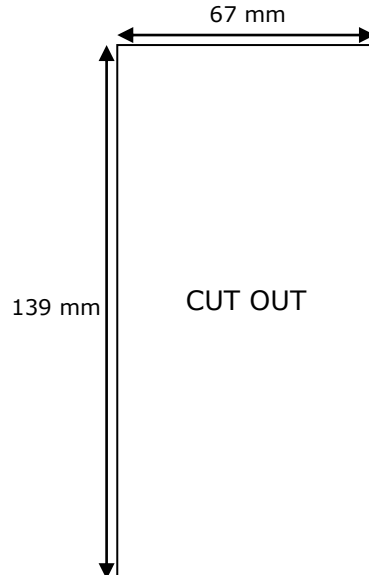



Optional equipment

Cut out size

Reset unit
(part of the 1st stage alarm)

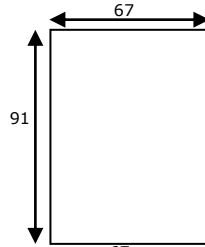

Officers selector switch
(part of the 2nd stage alarm)

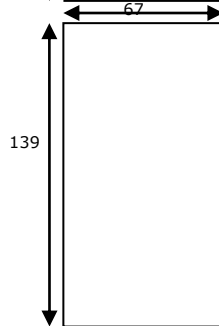

Cabin alarm unit
(part of the 2nd stage alarm)

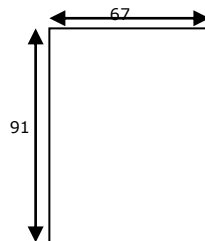

Alarm unit
(Part of the 3rd stage)





3 OPERATION

The ALPHA BNWAS is easy to operate by the push buttons on the front panel of the watch alarm. Adjustments can be made to time and auto/on/off when the key switch is in its vertical position. In this position the key cannot be removed.

When the watch alarm is in the ON position or the auto pilot is on duty, the watch time is between 3 or 12 minutes. When the key is in the horizontal position no changes can be made to time or auto/on/off settings.

When the time exceeds the selected time limit, the reset LED will begin flashing. After 15 seconds the internal buzzer or the bridge siren will sound. The Officer of the Watch has to respond within 15 seconds by pushing the reset button on the front panel or optional remote reset button.

If he or she fails to do so the resting Officer will be alarmed in his cabin via the Alarm Buzzer. If there is still no response the stage 3 call crew will be triggered after 90–180 seconds.

When the emergency mode is activated by pushing the emergency button on the front panel or the optional external emergency button somewhere on the bridge the watch alarm switches to “call officer” stage, and when no response the “call crew” will trigger.





The AlphaBNWAS is easily operated by the buttons on the front panel. Changes to time and on/auto/off mode can only be made when the key switch is in the vertical position. The key cannot be removed when the key is in the vertical position.

The 3 to 12 minute timer can be adjusted by pushing the time select button. The on/auto/off mode can be selected by pushing the on/auto/off select button. Activating the AlphaBNWAS will start the 3 to 12 minute timer until it exceeds. The "reset" LED will start blinking and the internal buzzer will sound for half a second giving a pre-alarm.

After 15 seconds the internal buzzer will pulsate continuously and the relay contact for the (optional) bridge siren will sound. If the officer on the bridge does not respond by operating the reset button within 15 seconds, the backup officer will be alarmed and "call officer" LED will light.

When the backup officer does not respond within the preset time (90-180 seconds) the entire crew will be notified by activating the general alarm. This last stage can be adjusted with the 16-position switch (0-F) behind the removable front panel.

The time is adjustable from 90 to 180 seconds in steps of 6 seconds (0=90 , F=180 seconds). When the "Emergency" button is operated the AlphaBNWAS will switch to "call officer" stage without activating acoustic signalling on the bridge. The LEDs on the front panel can be dimmed by holding the reset button for a few seconds.

To disable the internal buzzer remove the jumper positioned next to the 16-position switch.



With the 16-position switch you can adjust the time between the stage "call officer" and "call crew". This time can be adjusted to 90-180 seconds in steps of 6 seconds.
0 = 90, 1 = 96...E = 174, F = 180 seconds.



4 TECHNICAL SPECIFICATIONS

Power supply	18-36Volt DC
Max. current	180mA
Relay contacts	4
Transistor outputs	2
Relay switching current	30 Volt DC – 10A
	250 Volt AC – 10A
Transistor current	30 Volt DC – 300 Watt
	250 Volt AC – 2500 Watt
Communication interface	24 Volt DC – 500mA
	24 Volt DC – 12 Watt
Protocol	RS485
Communication parameters	NMEA
Cutting hole HxW	4800,8,N,1
Outer size HxW	139 x 67 mm
Depth	144 x 72 mm
	110 mm incl connector



5 VDR COMMUNICATION INTERFACE

The AlphaBNWAS is equipped with an RS485 interface intended to relay all available information of the watch alarm to the VDR (Voyage Data Recorder). The protocol to export data is NMEA, and is supported by almost every VDR. Messages are sent every second. The communication parameters and the data message is explained in the following tables.

Parameters communication interface:

Protocol	NMEA
Interface	RS485
Baudrate	4800
Data bits	8
Parity	None
Stop bits	1

NMEA message

\$ABWA,x1,x2,x3,x4,x5,x6,x7,x8,x9,x10,x11*<CRC>

Character	Description
A	Alphatron
B	Bridge
W	Watch
A	Alarm
X1	On mode
X2	Auto mode
X3	Off mode
X4	0/1 , 3 minutes/12 minutes
X5	Key switch deselect/set
X6	Reset button operated
X7	Emergency call operated
X8	Watch time running
X9	Reached bridge alarm level
X10	Reached call officer level
X11	Reached call crew level

* Character X1 - X11 = 0 or 1



6 TECHNICAL DRAWINGS

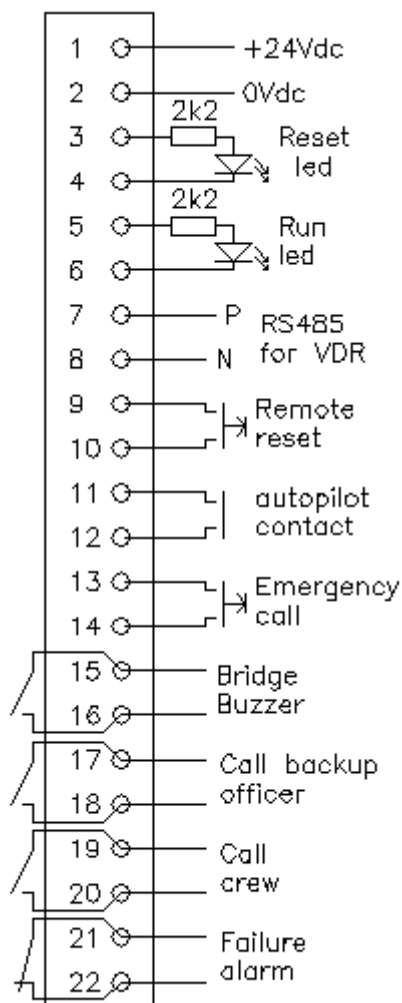



Below you can find an Example connection diagram with officers selector switch.

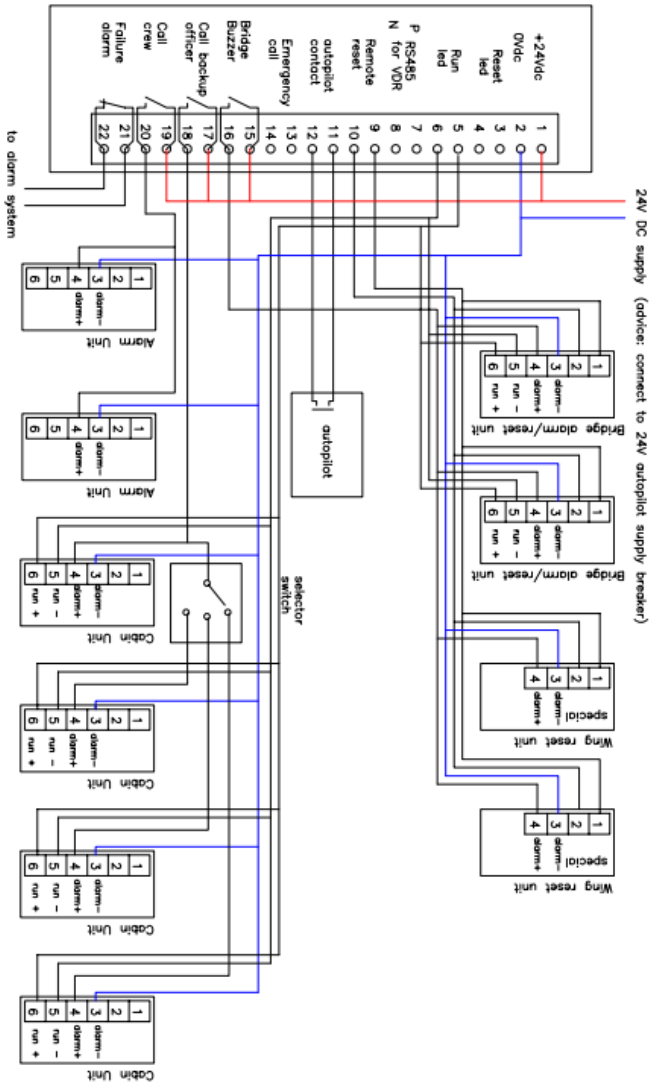

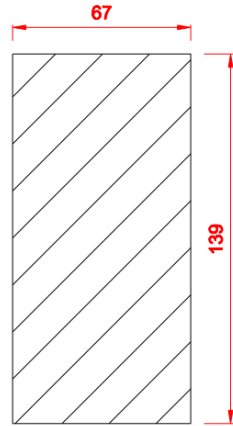
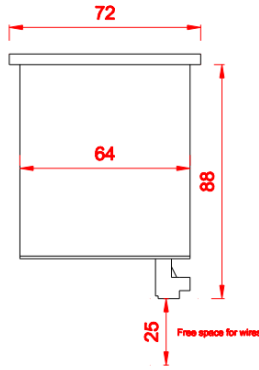
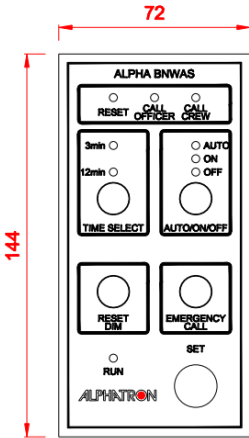

Panel Cut Out

(3115.0004)

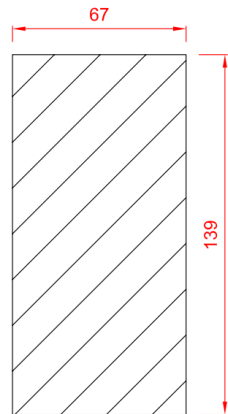
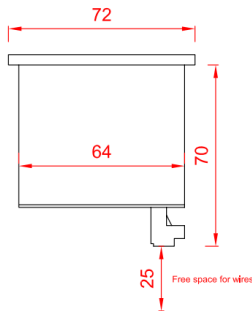
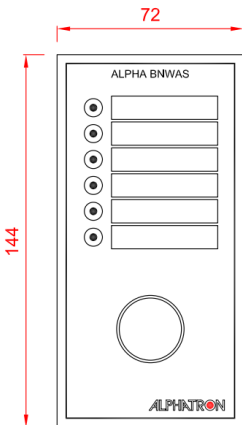

Panel Cut Out

(3115.0018)

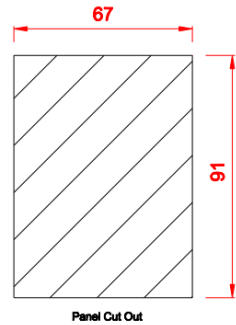
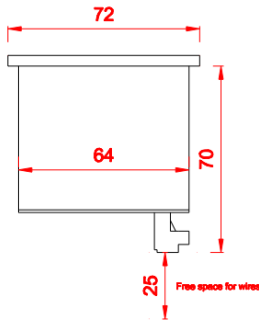
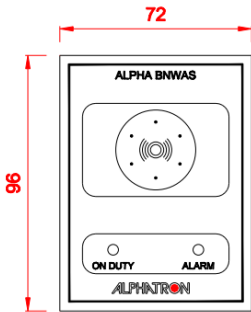
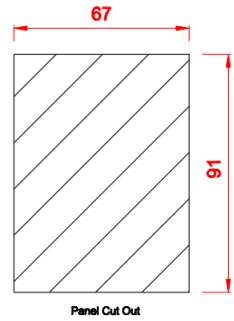
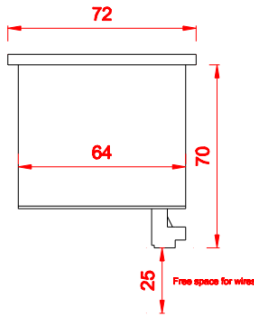
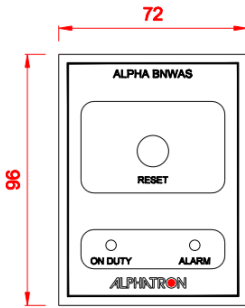

(3115.0006)



The information in this Manual is subject to change without notice and does not represent a commitment on the part of ALPHATRON MARINE B.V.

Document : Manual Alpatron ALPHA BNWAS
Issue : 1.0
Date : 06-12-2012
© ALPHATRON MARINE B.V.

ALPHATRON MARINE B.V.

Schaardijk 23
3063 NH ROTTERDAM
The Netherlands
Tel: +31 (0)10 – 453 4000
Fax: +31 (0)10 – 452 9214

P.O. Box 210003
3001 AA ROTTERDAM

Web: www.alphatronmarine.com
Mail: service@alphatronmarine.com